

QUALITY
MAINTENANCE
and MARKETING
of WHEAT
STORED *on*
FARMS *and*
in ELEVATORS
in KANSAS:

*Description,
Techniques,
and Innovations*

Bulletin 660

Agricultural Experiment Station, Kansas State University, Marc A. Johnson, Director

QUALITY MAINTENANCE AND MARKETING OF WHEAT STORED ON FARMS AND IN ELEVATORS IN KANSAS: DESCRIPTION, TECHNIQUES, AND INNOVATIONS¹

Carl Reed and Fred Worman²

ABSTRACT

This bulletin summarizes nearly 10 years of research related to wheat stored on farms and in elevators in Kansas. It describes on-farm equipment and pest control practices and typical storage conditions that affect grain quality. The cost-effectiveness of aeration, grain protectants, and fumigation was evaluated. Grain cooling by aeration was the most effective insect-control technique and had the lowest variable cost but often was managed poorly. Automatically controlled fans increased the efficiency and convenience of aeration for insect control. Malathion protectants performed poorly. Applying Reldan® (chlorpyrifos-methyl) protectant was more costly than other techniques but was generally effective. Treatment of farm-stored wheat with phosphine fumigants was shown to be often unsuccessful, and methods of making fumigation more effective in farm bins were tested. The relationships between producer, buyer, wheat quality (especially factors affected during storage), and price were investigated, and wheat marketing practices are summarized. Discounting practices at Kansas elevators appeared to provide a weak and mixed message relative to the importance of insect control in farm storage. Elevator-level storage and marketing practices also are reported. A detailed summary and recommendations for maintaining quality in farm storage are presented. An integrated program of sanitation, aeration, and monitoring is recommended.

ACKNOWLEDGMENTS

This research was sponsored by a special USDA grant, Management of Stored Grain Insect Problems, Numbers 86-CRSR-2-2754 and CRSR 88-34165-3315. Members of the research team whose efforts and results are summarized in this report include:

Department of Grain Science and Industry - John Pedersen (Principal Investigator and Project Leader), Lawrence Wong, James Skidmore, Melaku Girma, and Habib Ben Hamza. Department of Entomology - Barry Dover and Valerie Wright de Malo (Principal Investigators), Bh. Subramanyam, Terry Mize, and Esther Fleming. Department of Agricultural Economics - Bryan Schurle (Principal Investigator), Ronald Fleming, Steven Duncan, and Kelline Anderson. Department of Statistics - Joni Brochsmidt-Evans.

KSU faculty members Joseph Harner, Agricultural Engineering Extension, and Randall Higgins, Entomology Extension, added significantly to the information. The patience and cooperation of the scores of Kansas farmers and elevator managers who participated in these studies are much appreciated.

Note: Trade names are used to identify products; no endorsement is intended.

¹ Contribution no. 93-514-B from the Kansas Agricultural Experiment Station.

² Research Associate, Department of Grain Science and Industry and former Research Assistant, Department of Agricultural Economics, Kansas State University.

CONTENTS

	Page
Introduction	3
I Equipment and Practices for Farm-Stored Wheat	
1986 Survey	4
1991 Survey	4
II Conditions in Farm-Stored Wheat and Effectiveness of Pest Control Practices	
Insects in Farm-Stored Wheat	6
Temperature and Moisture Characteristics of Naturally Cooled Grain	7
Effectiveness and Economic Aspects of Prestorage Practices	8
Effectiveness and Economic Aspects of Protectant Application	8
Effectiveness and Economic Aspects of Fumigation	9
Effectiveness and Economic Aspects of Aeration	9
III Marketing Farm-Stored Wheat	
1991 Producer Survey	10
1991 Elevator Manager Survey	12
1991 Sample Study	17
IV Wheat Storage Practices and Conditions at Elevators	
1991 Interview Survey	19
Survey of Grain Storage Equipment and Practices	21
Study of Insect Presence in Elevators	21
Study of Infestation and Deterioration in Stored Wheat	22
V Improving Pest Control in Farm-Stored Wheat	
Delayed Application of Protectants	23
Protectant-Aeration Combination	23
Surface Covers for Fumigation	23
Ground-Level Fumigant Application	24
Fumigation-Aeration Combination	25
Automated Aeration	25
Summary	26
Recommendations for On-Farm Storage of Wheat	28
References	29
Figures	30
Tables	39

INTRODUCTION

This bulletin describes the most recent and important results of research on farm-stored wheat in Kansas. The projects that generated these findings began in 1984 and continued until 1992. The first of these studies described the equipment and practices used by Kansas farmers to store wheat on-farm and the practices of buyers relative to grain condition. These results and a description of conditions in farm grain bins were published by Reed and Pedersen (14).

The descriptive information in that bulletin provided a “snapshot” to guide subsequent research. Studies were undertaken to assess the effectiveness of the pest control practices used on-farm and to estimate the impact of quality deterioration during farm storage on the grain handling system as a whole. Other projects investigated the real-world relationship between grain deterioration during farm storage and price discounts at elevators. This information, in turn, was used to determine the cost-effectiveness of various pest control practices. Finally, innovations designed to make the most cost-effective techniques more safe, useful, and profitable were tested.

The time frame of these studies coincided with a series of macro-level changes that greatly affected farm storage. The popularity of on-farm storage in Kansas had increased steadily through the 1960’s and 1970’s. This was due partly to government programs that provided low-cost loans for farm grain bins and equipment and direct payments for long-term farm storage. High grain prices and volatile markets in the mid-1970’s also encouraged farm storage.

In the 1980’s, several factors combined to reduce the profitability of farm storage. The Farm Storage and Drying Equipment Loans Program was phased out in 1982, and by 1990, farm storage payments from the Farmer-Owned Reserve program had become insignificant. Construction of new farm bins slowed to very low levels. Of the Kansas farm bins being used for wheat in 1986, about 17 percent had been built between 1975 and 1985, whereas more than twice that number had been constructed between 1965 and 1975 (14).

The 1980’s also witnessed major changes relative to pest control chemicals used in farm stores. Since shortly after World War II, farmers had relied on liquid fumigants to control insects in stored grain. The main ingredient of the most widely used fumigants was carbon tetrachloride, which came under investigation in the mid-1980’s as a potential carcinogen. In 1986, the sale of these fumigants was banned. All grain fumigants containing ethylene dibromide (EDB) had been removed from the domestic market in the previous year for the

same reason. Therefore, farmers were forced to rely on the solid phosphine fumigant formulations, which are applied as pellets or tablets. Phosphine fumigants are more difficult to use in farm bins than were liquid fumigants. Increasingly strict safety regulations also are making farmer-applied fumigation less attractive. Also, certain strains of target insects in the southern plains and elsewhere have developed resistance to phosphine fumigants (26).

Malathion, a pest control chemical that has been used as a grain protectant for farm-stored grain since shortly after World War II, was no longer useful by the end of the 1980’s. A new insecticide, chlorpyrifos-methyl (Reldan[®]) was registered in 1985 for direct application to stored wheat. It became popular, despite its high cost relative to other available, quality, maintenance techniques, partially because it was the only effective protectant currently registered for that use. Unfortunately, it is not always effective against the lesser grain borer, the most destructive insect of Kansas farm-stored grain (26). Thus, by the end of the 1980’s, both the standard insecticide and the standard fumigant treatments for farm-stored grain were replaced with more expensive and demanding products.

Quality issues in the wheat marketplace also underwent radical changes in the late 1980’s. Increased consumer concern about the wholesomeness of food is a trend dating back to the 1950’s in the U.S. In the grain trade, this has manifested itself in increasingly strict limits of insect contamination. In 1988, the U.S. grain standards for wheat were changed in two ways that affected marketing of farm-stored wheat. First, content of insect-damaged kernels (IDK) was determined and reported as a separate factor. Thirty-two or more IDK per 100 g of wheat caused a sample to be downgraded to “sample grade.” However, flour mills adopted much stricter standards for rejection, often as low as 5 IDK/100 g. The second change reduced the limit of live insects for a wheat sample to avoid the special designation “infested”.

This was the environment in which the series of field investigations reported here were conducted. Farmers had fewer pest control methods available to them just when the market was demanding a cleaner product. This bulletin represents the most recently acquired knowledge about Kansas farm storage, the relationship between farm storage and the rest of the marketing chain, the most cost-effective methods of maintaining grain quality in farm storage, and techniques to increase the convenience and effectiveness of these pest control methods.

I. EQUIPMENT AND PRACTICES FOR FARM STORAGE OF WHEAT

1986 SURVEY

The 1986 survey (14, Fig. 1) provided basic information about the types of structures in which Kansas farm-stored wheat was being held. It showed that the capacity for on-farm storage was not distributed equally by geographical area within the state or between farms. The majority of producers who stored wheat reported capacities of 20,000 bu (540 t) or less. However, as a percentage of the total, this group collectively accounted for only about one-fifth of the on-farm capacity. A few (12.5 percent) large farms accounted for nearly half of the state's on-farm wheat storage capacity. Most of these large farms were located in the southwest corner of the state. Whereas the average, reported, storage capacity for wheat was about 12,000 bu (324 t) per farm in central Kansas, it was about 40,000 bu (1081 t) per farm in western Kansas.

The survey showed that virtually all farms on which wheat was stored contained cylindrical metal bins and the vast majority of the farm-stored wheat was kept in these structures. A few farmers stored wheat in wooden structures, but the amount was insignificant to the state total. Flat stores also were used occasionally, accounting for nearly 15 percent of the total reported capacity, but most of this consisted of tool sheds wherein wheat could be stored on the floor if no other space were available.

Cylindrical metal bins can be classified by size, type of floor, and aeration system. Bins with flat concrete or metal floors were the most common type in Kansas. They were found on 79.4 percent of the surveyed farms and accounted for 52.4 percent of all bins. Hopper-bottom bins were also common, but more so in western than in central Kansas. They were found on 41.8 percent of surveyed farms and accounted for 29.1 percent of all storage structures.

Most cylindrical metal bins in the survey area had some type of aeration equipment, consisting of a fan and either air ducts located in or on the floor or a false floor of perforated metal. About six of every 10 surveyed bins had aeration capability, but because aerated bins were usually larger than bins without aeration, about three-quarters (76.5 percent) of the on-farm storage capacity used for wheat in Kansas had aeration equipment. Most of the total storage capacity was represented by bins built since 1965, and nearly 20 percent, virtually all aerated, was built since 1975.

The picture that emerged from the 1986 survey and subsequent field studies indicated different types of farm operations relative to on-farm wheat storage. The first type becomes more common as one moves west and south through the state. It is characterized by relatively new and large bins with aeration capability. Storage capacity for wheat ranges from 20,000 to 250,000 bu (540 to 6,760 t), and wheat storage is an important part of farm income. The second type is more common in central and eastern Kansas. Storage structures usually used for wheat tend to be smaller and are less likely to have aeration equipment. Other crops and farming activities tend to be more important to farm income than

wheat storage. These generalizations, of course, are not absolute. An individual farm in either group is likely to have some characteristics of the other. Nearly every farmer anywhere in Kansas is involved in several activities other than wheat production and storage. And anywhere in the state, one is likely to find small, unaerated, grain bins, especially for storing seed wheat. Still, the generalization that a large number of Kansas farmers are involved in farm storage of wheat in a rather peripheral way is valid. They have a small investment (relative to other economic activities) and seem less interested in quality maintenance. A smaller number of farmers have a large investment in on-farm wheat storage and, therefore, a greater incentive to maintain grain quality.

The 1986 survey also supplied basic information about how Kansas farmers cared for their farm-stored wheat. In most years, Kansas wheat is dry at harvest, which facilitates storage. About two-thirds of respondents reported that 1985-crop wheat had entered the bin containing 12 percent or less moisture. Another 20 percent said that most of the wheat they had stored contained between 12 and 13 percent moisture. Nearly all respondents said they cleaned bins, and three-fourths said they had sprayed their bins with insecticide prior to filling them. Other common quality maintenance practices were preventative grain fumigation (27.1 percent) and application of a grain protectant to the wheat as it was being transported to the bin (53.5 percent). Periodic inspection of stored grain is an important component of any quality maintenance program. Most (81.0 percent) respondents said that they inspected their farm-stored wheat on a regular basis, usually by observing the grain surface, scooping samples from the surface, or taking samples with a probe. Overall, the percentage of respondents reporting the use of temperature-monitoring devices was small (7.9 percent), but 19.2 percent of those with 40,000 bu or more had temperature monitors.

1991 SURVEY

The questionnaire survey was repeated in 1991 to measure the effect of the 1988 changes in the U.S. grain standards and to obtain more detailed information about certain pest control and marketing practices. Questionnaires designed to elicit information relative to on-farm pest control and to describe producers' perceptions of buyers' policies were developed and tested. Questionnaires were distributed in March, 1991 to all farms selected in the 1986 study. The development of the 1986 list was described by Reed and Pedersen (14). It began with 55 randomly chosen farm sites in each of 28 central and western Kansas counties. Sites where wheat was not stored were removed from the list. In late April 1991, follow-up letters and questionnaires were sent to persons from whom no response had been received.

The 1986 cooperators' list included only wheat producers who stored wheat on-farm at that time. By 1991, 23 (7.4 percent) were deceased or had moved out of the area, so the questionnaire was sent to 289 potential respondents. Of these,

82 (28.4 percent) returned the questionnaires indicating that they no longer stored wheat on-farm. One hundred twenty-one completed forms were received and used in the following analysis (a total response rate of 70.3 percent).

Data were analyzed with SAS statistical software (21). In some cases, responses were compared by geographical location. Kansas Crop Reporting Service districts were used to define these zones (Fig. 1).

Approximately one-fourth of the respondents had ceased wheat production or farm storage of wheat between 1986 and 1991. This reflects the general decline in the amount of farm-stored wheat in Kansas during the last half of the 1980's. According to Kansas Agricultural Statistics reports, the proportion of the annual wheat crop stored on Kansas farms in October decreased from an average of approximately 26 percent between 1984 and 1986 to about 21 percent between 1987 and 1989. In 1990 and 1991, the proportion was less than 15 percent.

The percentages of respondents that reported using a particular type of pest control (Table 1) were very similar to those in 1986. More than 80 percent reported that they accomplished routine sanitation and disinfestation tasks, such as cleaning and spraying empty bins or cleaning up spills. About half reported leveling the grain after filling. Although this is about the same proportion as in 1986, it is an unfortunately low number, because field work has shown that peaked grain is at greater risk of deterioration than level grain. The proportion of respondents that reported using a grain protectant increased from about half in 1986 to nearly three-quarters in 1991. This suggests increased reliance on grain protectants.

One half (50.8 percent) of the respondents indicated that their farm-stored wheat had been fumigated during the previous storage season. About half of these, 27.1 percent of the total, said that they had fumigated the same grain more than once. The relationship between use of grain protectant and fumigation appears to demonstrate different risk-reduction strategies. A minority of respondents (15.1 percent) used both a grain protectant and a preventive fumigation. About the same number (16.5 percent) used neither protectant nor fumigant. Of the 71.1 percent who used a grain protectant, more than half (55.8 percent) eventually fumigated. The motivations for these fumigations varied among respondents. Nearly half (41.8 percent) of those who responded indicated that they fumigated to avoid a damaging infestation. One in five said they fumigated to destroy an existing, known infestation, whereas 38.2 percent indicated that the fumigation was both corrective and preventative. Regardless of the reason for the fumigation, the large proportion of farms where wheat already treated with protectant was fumigated indicates that protectant treatment alone did not always control insects.

Sixty-one percent of those who claimed to have fumigated during the previous year said that they accomplished the fumigation themselves. About one-third (39.0 percent) said someone else had done the fumigation. This included 35.6 percent that had hired a pest control operator to fumigate the grain. The use of hired fumigators appears to have increased

markedly since 1986, when 12.5 percent reported hiring a commercial fumigator.

About two-thirds (69.7 percent) of the respondents reported that the fumigant used was a solid preparation or otherwise indicated that a phosphine fumigant was used. However, 21.1 percent reported that they used a liquid, and 12.3 percent said both a liquid and a solid were used. Because the once-popular liquid fumigants have not been marketed for several years, these responses probably indicated that many respondents confused the use of liquid insecticide with fumigation. In 1986, about two-thirds claimed to have used a liquid fumigant. Chloropicrin, a liquid, is still available as a grain fumigant, but very little is sold in Kansas for this purpose (personal communication, Douglas Chemical Company). Seven percent of the respondents said a gaseous fumigant was used, which may indicate methyl bromide.

Previous experiences with price discounts were significantly ($p < 0.01$) related to pest control practices. Among respondents who said that buyers had previously discounted the price of their wheat because of infestation, 75.0 percent had fumigated their farm-stored wheat. Among those who claimed not to have had experience with such price discounts, 44.6 percent said they had fumigated in the previous year. The association between having experienced discounts for insect-related factors and the likelihood of having fumigated more than once was also highly significant ($P < 0.01$). A third of those who had been discounted for insect-related factors had fumigated more than once, compared with 8.9 percent of those who said they had no experience with this type of discount. We interpret this to mean that persons who had experienced a price reduction because of insect-related factors were more likely to invest in grain fumigation thereafter.

About two-thirds of the respondents indicated that they used aeration to cool grain (Table 1). The remainder included the 28.1 percent who did not cool grain because they lacked aeration equipment and 8.3 percent who said that they have the equipment, but do not use it for wheat. Observations during field work on Kansas farms suggest that the proportion of producers who have aeration equipment but do not use it is much larger than one in 12.

Of those who indicated that they cooled farm-stored grain with aeration, 10.4 percent said that they aerated wheat but not fall crops. Another 15.6 percent said that they aerated fall crops, but not wheat, whereas 67.5 percent indicated that both wheat and fall crops were cooled with aeration. Of those who aerated wheat, 61.5 percent said that all wheat was aerated.

Among those who aerated, about two-thirds (64.8 percent) said that they began the cooling process shortly after harvest, whereas 35.2 percent said that they waited until fall. These proportions are not markedly different than those in 1986. Of the respondents who said that they did not aerate in summer, 18.1 percent began aerating in September. About half (47.1 percent) began in October, and 23.5 percent began in November. The remainder indicated that they began cooling in December.

The respondents also were asked the temperature to which they cooled their farm-stored wheat and the total

number of hours required to do so. Nearly one in five said that they operated their fans 1 day or less (Fig. 2). Fifteen percent said that cooling took 2 days, and 20 percent reported operating fans for 3 days. Overall, only 21.7 percent reported total cooling time in the 150-300 hour range, which is the average requirement for farm-level grain aeration. Most respondents reported more fan hours in 1991 than they did in 1986. The percentage who said that they logged 120 or more hours of fan operation increased from 16.3 percent in 1986 to 23.3 percent in 1991. A corresponding decrease occurred in the proportion that reported an exceptionally small number of hours (60 or less), from 57.1 percent in 1986 to 45.0 percent in 1991. In 1991, the target grain temperatures ranged from 0° to 65°F, with a mode of about 35°F. About half (46.7 percent) of the reported target temperatures were in the 32° to 40°F range. The target temperatures usually recommended are 40° to 50°F.

As was observed in the 1986 survey, respondents were less likely to answer as questions relative to aeration became more specific. Whereas fewer than 5 percent neglected to respond to most items about other types of pest control, about 6 percent skipped the first question about the details of the aeration scheme. More than 20.0 percent abstained from

answering the question about total hours of aeration, and 61.0 percent of those who said that they aerated did not respond to the question about target temperatures. The small percentage of reasonable answers and the lack of specifics on the aeration strategy are interpreted to mean that farmers are less confident of their understanding of aeration than of other types of pest control for stored grain.

Producers in different parts of the survey area responded similarly on most items. However, respondents from the western third of Kansas responded differently from those in central Kansas on selected items related to pest control and grain marketing. For example, producers in western Kansas appeared to rely more on fumigation and aeration. Whereas 39.1 percent of respondents in the central third of the state indicated that they did not have aeration equipment, only 13.5 percent of those in the west marked this response, a significant ($p < 0.01$) difference. More than half (59.6 percent) of respondents from western Kansas said that they had fumigated their farm-stored wheat in the previous year, whereas 43.9 percent of respondents from central Kansas had done so. In contrast, respondents in the central zone were more likely to have used a grain protectant than those in the west (76.8 percent and 63.5 percent, respectively).

II. CONDITIONS IN FARM-STORED WHEAT AND EFFECTIVENESS OF PEST CONTROL PRACTICES

INSECTS IN FARM-STORED WHEAT

The surveys described in the previous section provided information about quality maintenance practices used by Kansas farmers. In order to define the factors that affected the quality of farm-stored grain and to determine the effectiveness of quality maintenance practices, a series of studies was accomplished on Kansas farms between 1984 and 1992.

The earliest studies confirmed the common knowledge that molds, which cause deterioration of higher-moisture grain, seldom were major factors in the deterioration of farm-stored wheat in Kansas. Because most Kansas wheat is harvested dry, molding problems occur only infrequently. However, such problems do occur when grain that is harvested too wet is placed in farm bins, in late spring in unaerated grain lots that have experienced excessive moisture migration through the winter, and when rain or drifting snow wets the grain during storage. Because molding problems are infrequent and preventable, our research focused mostly on control of insects, although some experiments were directed toward temperature and moisture migration phenomena.

In 1985, 24 empty bins were examined shortly before they were filled with newly harvested wheat (14). On 19 of the farm sites, stored-product insects were observed by visual inspection of the bin areas. Live insects were observed inside 12 bins, in 2 of 21 combines, and in 6 of 18 grain trucks just prior to harvest. On most of the farms wherein large numbers of insects were found, the insects were infesting bulk feed. This was an indication, confirmed by subsequent observations, that on farms where a consistently severe infestation problem

occurs in stored grain, animal feed is a likely source of the infestation. In general, this study showed that, by harvest time (June or July), stored-grain insect populations have recovered from winter's freezing temperatures, and insects are colonizing any area on the farm where they encounter enough grain or grain-based material to sustain their growth.

In 1986, randomly selected farm bins were sampled within a month after harvest and through the winter to determine types and density of stored-grain insects present (18). Insects were detected in three-fourths (76.9 percent) of the bins in July and in nearly all bins (97.1 percent) in the fall. Even lots that had been treated with insecticide or fumigant typically contained some insects. Although the insect density was very low shortly after harvest, it increased to nearly 7 insects per 1000 g sample in early winter in lots that had not been treated (Fig. 2). As winter progressed, the insect numbers decreased to less than one per sample. This build-up of insect populations through the fall and early winter, with a subsequent decline after 2 or 3 months of winter temperatures has been observed in Kansas (23) and elsewhere (3). In many bins, the insect numbers declined even though no control measures were applied, indicating that the pattern of insect population growth and decline shown in Figure 2 may be a typical, "natural," growth pattern in farm bins.

Most of the insects found in grain samples were the less damaging types, such as flat or rusty grain beetles (*Cryptolestes* spp.), flour beetles (*Tribolium* spp.), or sawtooth grain beetles (*Oryzaephilus* spp.), but one lesser grain borer (*Rhyzopertha dominica*) was encountered in every second or third sample,

on the average, in September, November, and January (Table 2). This latter insect can cause severe damage. In a select group of these bins, some internal infestation by lesser grain borer was detected in about 20 percent of the bins in September and in more than 40 percent by January (20). The average, damaged-kernel, total content (DKT) doubled in these grain lots between harvest and January.

These studies clearly showed that late fall is critical to quality maintenance in farm-stored wheat. In lots wherein insects severely threatened grain quality, the threat was apparent by late October. Conversely, if insect density was low through November, damaging infestations did not develop, even in lots to which no control measure was applied. Investigators encountered several cases over the years of study wherein lots became severely damaged, always because of lesser grain borers. Very high counts of insect-damaged kernels (IDK), grain heating, and objectionable odors were associated with these lots. This appeared to occur in one of about every 40 bins examined.

The lesser grain borer is an especially dangerous insect to farm-stored wheat in Kansas because of the grain damage it causes and because it is a strong flier. Pheromone-baited traps were used to detect flights of lesser grain borer in an agricultural area near Manhattan, Kansas in 1990 and 1991. Traps were monitored three times weekly, and pheromone lures were replaced at monthly intervals.

The findings corroborated those of other researchers who have conducted similar studies in Kansas and nearby states. Lesser grain borers were not detected until May (Fig. 4). Thereafter, peaks of flight activity appeared to occur at approximately monthly intervals, with only small numbers of insects trapped between the peak times in June and July. In August and September, large numbers of insects were detected each time the traps were monitored, and in 1990, an interval of exceptionally great activity occurred in late August. In early fall, another peak of flight activity was noted, but no insects were detected after October. Absolute numbers varied between sampling sites and years, but the pattern was consistent.

The reason for the monthly peaks of flight activity is not known. The recent finding that newly emerged adults are significantly more likely to fly than are adults older than 9 days (B. Dover, Kansas State University, personal communication) has led to speculation that the peak flight periods may coincide with periods when large numbers of adults emerge simultaneously. However, the lesser grain borer, unlike many field insects, is not known to hibernate in response to cold weather. Therefore, populations should be of mixed age, with the ratio of emerging adults to other life stages being relatively constant. Furthermore, the development time of this insect under conditions typical of spring and early summer is longer than the intervals between peak flight periods.

Whatever the reason, the mobility pattern of lesser grain borer has consequences for management of stored wheat in Kansas. The large numbers of these insects detected in sites far from stored grain indicated that the population reservoir of this insect is replenished each spring and summer, constituting an annual threat to newly harvested wheat. The pattern of this

insect's movement coincides with detection patterns from grain sampling studies. In the 1986-87 study, lesser grain borers were detected in grain samples from 3.9 percent of the farm bins in July, 34.3 percent in September, and 50.0 percent in November. The 1986 study showed that lesser grain borer constituted an increasingly larger percentage of all insects in farm-stored wheat through the storage season. Whereas in July, 6.3 percent of all insects collected were lesser grain borers, by November, the percentage had risen to 9.2, and by January, to 39.7 percent. Thus, fall is the critical time for farm-stored wheat, not only because the insects that infested newly harvested wheat early in the summer are able to produce offspring by September, but also because the invasion of lesser grain borer from surrounding areas is greatest in late summer and early fall.

TEMPERATURE AND MOISTURE CHARACTERISTICS OF NATURALLY COOLED GRAIN

Patterns of heat and moisture distribution in stored wheat were studied in an experiment in 1987. The grain was not aerated during the experiment in order to document changes from natural cooling. Temperature-monitoring devices were located throughout the grain mass, and grain temperature and moisture were determined every 28 days in a 10,000 bu bin (26-30 ft diameter) and a smaller bin (14-18 ft diameter) on each of three farms.

Natural cooling began at ground level (Fig. 5) and continued into the center of the bin and later around the walls and surface. In the large bins by November, this created a donut-shaped warm area at the middle level and an even warmer spot near the center a few feet below the surface. In the smaller bins, the warm spot tended to be located more toward the center of the grain mass. By January, the warm area below the center surface was surrounded by an envelope of cold, dense air, especially at the surface.

The small grain masses cooled faster than the larger masses. Whereas the warmest grain in the small bins reached the average ambient temperature after about 3 or 4 months, the warmest grain in the large bins never cooled below about 67°F (Fig. 6). Even in the small masses, the center did not cool to 50°F, the critical temperature for insect control, until late winter.

Moisture was redistributed in grain that showed temperature differences from one part of the mass to the other. In August, grain scooped from the surface contained an average of only 11.2 percent moisture (Fig. 7). By February, the moisture content had increased to nearly 14.5 percent. Surface grain then lost moisture as the warm spring sun heated it and air in the space above it. Grain located near the middle and bottom of the mass steadily lost moisture during the storage season, whereas grain 2 feet below the surface steadily gained water. In contrast to the surface grain, grain 2 feet below the surface retained this moisture into the spring and summer. The accumulation of moisture in an area close enough to the surface to warm quickly but remote enough to

retain its accumulated water is a likely cause of springtime heating in unaerated grain bins. Grain in one of the large bins heated and caked, and the deteriorated grain had to be removed by hand. In winter, researchers also encountered many bins with large accumulations of snow at the top center. Moisture from melting snow may be another common cause of grain heating in the spring.

EFFECTIVENESS AND ECONOMIC ASPECTS OF PRESTORAGE PRACTICES

Research in the 1930's (5) and 1940's (23) established that stored-grain insects do not infest wheat in Kansas fields to any great extent, and, therefore, infestation of newly stored wheat must occur after storage from sources reasonably near the storage site. Our studies in the 1980's did not detect field infestation by stored-grain insects, although Ben Hamza (4) demonstrated that lesser grain borers are capable of colonizing standing wheat just prior to harvest. Producers and grain handlers periodically report field infestation by these insects, but these observations have not been confirmed. In 1988, newly harvested Kansas wheat had an elevated percentage of damaged kernels. The damage was so similar to that produced by storage insects that some samples were determined by official inspection to have high IDK counts. However, tests showed that the damaged kernels did not produce insect fragments in flour made from the wheat, and, therefore, were not the result of stored-grain insects developing within the kernels (15).

Long-standing recommendations relative to insect control at grain sites include removing spills and grain debris from around bins and from augers, combines, and truck beds. Cooperative Extension Service literature also recommends that bins be cleaned and sprayed with an approved insecticide about 2 weeks prior to harvest. To examine the effectiveness of these practices, tests of association were conducted using the 1985 data described above. The probability and/or density of infestation in the empty bin prior to harvest and/or in the wheat just after harvest was compared with prestorage practices. The effects of some practices (clean-up of spills, etc.) were too subjective to compare accurately. Although treating the empty bin with insecticide killed some insects, whether the bin had been sprayed was not associated significantly with the presence or number of insects either in the empty bin or in the wheat immediately after harvest. Where live insects were found in bins that had been sprayed, they were often in accumulations of grain material, indicating that the thoroughness of cleaning is important to the success of empty bin sanitation. The 1986-87 study provided statistically significant ($p < 0.05$) evidence that bin spraying helped to suppress insect numbers for 2 or 3 months after harvest.

EFFECTIVENESS AND ECONOMIC ASPECTS OF PROTECTANT APPLICATION

Grain protectants are insecticides that are labeled for direct application to grain. Their function is to kill invading insects before they can reproduce or cause serious grain

damage. Two such insecticides are presently available for application to wheat. Malathion has been used for many years, and commercial formulations are produced under a number of brands and trade names. Chlorpyrifos-methyl (CM) was registered in 1985 under the trade name Reldan[®]. It was relatively unfamiliar to farmers when our 1986 study began. Therefore, most of the surveyed wheat that had received a protectant probably was treated with malathion. About two-thirds of the farmers whose wheat was sampled in September of that year said they had applied a protectant, yet only 20.8 percent of the samples contained any insecticidal properties, as determined by bioassay (13). In November 1986, the lots that were known to contain protectant had significantly fewer insects than untreated lots. However, by January, the detectable benefit of the protectant treatment was gone. Cost-benefit analysis showed that even in the fall, when the protectant suppressed insect numbers, the total cost associated with the treatment was not significantly different than the total cost for untreated grain.

Although the results of the 1986 study showed that the benefits of using grain protectants were short-lived, some aspects required further analysis. The new CM insecticide was thought to be more effective than malathion, and we saw indications that CM was replacing malathion for farm use in Kansas. Thus, some parts of the field study needed to be repeated to determine the cost-effectiveness if CM were used instead of malathion.

Studies conducted in 1989 and 1990 further evaluated the cost-effectiveness of grain protectants. The index of cost-effectiveness consisted of the cost of the protectant, the cost of fumigating lots wherein the protectant failed to control insects, and the potential value of price discounts for infestation if the grain had to be sold. In 1989, CM treatment was compared with no treatment in unaerated wheat. The protectant was effective through November and eliminated the need to fumigate during the first 4 months of storage (16). However, populations of lesser grain borer were becoming established in the warm grain by December, and one of the four CM-treated bins had to be cooled with aeration to avoid damage. Because the cost of the protectant was greater than the costs incurred when CM was not applied, total costs associated with the protectant treatment were higher than those associated with no treatment (Table 3).

In 1990, grain treated with CM and malathion was compared to grain not treated with protectant (Table 3). In this trial, all grain was aerated and prestorage sanitation was optimum. Under these conditions, the malathion-treated wheat was as likely as untreated wheat to develop damaging insect infestations, and two of the four lots treated with malathion had to be fumigated to avoid grain damage. Chemical breakdown of the protectant from elevated summer temperatures was implicated in the failures. Because of the failures, malathion treatment was not cost-effective. The CM treatments controlled insects in combination with aeration, and none of the lots had to be fumigated. However, because of its higher initial cost, the overall costs associated with using CM made it a more expensive option than not using protectant.

EFFECTIVENESS AND ECONOMIC ASPECTS OF FUMIGATION

Fumigants are chemicals that form toxic atmospheres. For many years, the most common method of fumigating farm-stored grain was to pour a liquid fumigant onto the surface. However, the liquid fumigants were withdrawn from the market in the early 1980's, and solid phosphine fumigants are now used most commonly for farm fumigation (see Part 1). Although the tendency to hire commercial pest control firms to fumigate farm grain is increasing, the majority of farm fumigations still are accomplished by the producers. The characteristics and effectiveness of farm fumigations had not been documented when the Kansas studies began.

For wheat, fumigations usually are performed during fall and winter. Of the bins monitored in 1986-87, for example, none had been fumigated in July, whereas 28.6 percent were fumigated by mid-September, and 50 percent of the bins still containing grain in January and March had been fumigated (13). Because most producers do not fumigate until they observe evidence of infestation, and insect numbers are greatest in late fall, this was the expected pattern.

Data from the 1984-85 studies appeared to indicate that fumigations done after late November had a low success rate (12). Of the bins sampled in February, nine had been fumigated. Four of the five that had been fumigated after mid-November contained more than one insect per 1000-g sample, and one of these lots contained about 23 insects per sample. All lots that had been fumigated before mid-November contained fewer than one insect per sample.

Other data (13) showed that fumigations also could be done too early in the season. In 1986, 91 percent of all lots that had been fumigated by the mid-September sampling date were infested and contained an average of 3.2 insects per 1000 g, about the same as lots that had not been fumigated. At later sampling dates, the average insect density was lower in fumigated than in unfumigated grain. These two results combined to reinforce the conventional wisdom that there is an optimum time to fumigate farm wheat. If fumigation is done too early, that is, during warm weather, in-migrating insects (especially the lesser grain borer) have the opportunity to reinfest. If fumigation is done after late November, parts of the grain mass may be too cold for an acceptable kill to be achieved. Therefore, October or early November, after the fall flight peak of the lesser grain borer, appears to be the optimum time for fumigation of farm wheat in Kansas. However, even fumigations done at the proper time were not always successful.

We did not conduct experiments specifically to address the cost-effectiveness of farm bin fumigation, because successful fumigation obviously would be cost-effective. In 1987, the average cost of phosphine fumigants in the study area was the equivalent of 0.9¢ per bushel (13), whereas average discounts for delivering infested wheat ranged from 1.4 to 3.5¢ per bushel, depending on the test weight (19). These area-wide averages provide insight into tendencies, but for the individual producer, the cost-effectiveness of a successful fumigation depends on the level of infestation and the policy of the buyer.

In many cases, discounts of 5¢ or more are charged per bushel for infested wheat (19), and fumigation, if successful, returns the investment five times. In other cases when a light infestation is not detected or the discount policy is lenient, the cost of fumigating may be greater than potential benefits.

EFFECTIVENESS AND ECONOMIC ASPECTS OF AERATION

Aeration, the forcing of air through the grain mass, is used most commonly to remove heat from grain. Cooling the grain helps retain the potency of protectants and retards insect growth. Most Kansas farms on which wheat is stored have bins equipped for aeration (Part 1). The larger the bin, the more likely it is to have aeration equipment. However, investigators have noted that aeration is often unused or misused on many farms, and questionnaire results appear to indicate that much confusion exists about the proper use of aeration.

As the early Kansas studies were begun, results of a study in Oklahoma showed that aeration was a useful insect control technique for farm-stored wheat in the hard red winter wheat area (6). The authors reported a substantial reduction in the levels of infestation and the proportion of lots requiring fumigation in aerated compared to unaerated lots of farm-stored wheat. In the early Kansas studies (1984-1986), aeration was not a controlled variable, but we saw many indications that aeration affected insect populations.

In 1988, the recommended, three-cycle, aeration scheme was compared with a single-cycle scheme on two farms. Aeration was controlled by the producers, who selected cool hours for fan operation within a prescribed time period. Hygrothermographs recorded the conditions of ambient air and the air between the grain surface and the bin roof. Results showed that the first difficulty in aeration management was detecting and utilizing cool air. Although the objective was to cool the grain soon after harvest, air cool enough to use for aeration (at least 15°F cooler than the grain) seldom was available within the first months after harvest (July and August), and these low temperatures occurred only between midnight and 6:00 a.m. or during rainy weather. Meanwhile, daytime temperatures in the space above the grain exceeded 120°F (49°C) on each of 14 successive days during one period in late August and for 37 hours total during that period. The number of insects captured in pitfall traps (4-day trap time) increased by a factor of about three between July and September in the uncooled grain lots awaiting the single aeration cycle.

By the end of November, ambient temperatures were cool enough to run the fans continuously, and all grain was cooled to below 50°F (10°C). However, in the lots that remained warm until November, infestation became serious, and one lot had to be fumigated. The other lot became infested with lesser grain borers, which were killed when aeration reduced the grain temperature from 77°F to 46°F (25°C to 8°C) in 2 days. Although the single-cycle scheme required less electricity than the three-cycle scheme, the savings were small (0.25¢/bu compared to 0.45¢/bu) relative to the cost of fumigating or to the possibility of grain damage from high levels of insect

infestation. The use of aeration early in the storage season obviously was preferable to waiting until November. However, early aeration had several disadvantages. It required that the aeration manager anticipate cool nighttime hours and activate the fans before retiring for the night, then shut the fans off early in the morning. It also required that the manager record grain temperatures in order to determine if the aeration cycle was complete. Even if this was done, grain temperatures sometimes were not cooled enough in August and September to avoid infestation.

III. MARKETING FARM-STORED WHEAT

Incentives to maintain the quality of farm-stored wheat must be provided by the marketplace. Quality maintenance in farm storage requires investment, and the desire to invest in pest control is driven by the producer's perception of the probable return to that investment, either in the form of premiums for high-quality grain or in terms of discounts avoided.

The relationship between quality maintenance practices in farm storage and the marketing consequences of those practices has been investigated in a variety of ways. Questionnaire surveys of producers who stored wheat on-farm were conducted in 1984, 1986, and 1991. Respondents described the incentives to maintain grain quality and the policies of their buyers from their point of view. Interview surveys of elevator managers were conducted in the same years. The managers explained their discounting and premium policies, their perception of the buyer-seller relationship relative to wheat quality, and their strategy for handling deteriorated wheat. In 1986-1987 and 1990-1991, sampling studies generated a more objective measure of the relationship between grain quality and price for farm-stored wheat. The measured quality of samples was compared to the discounts applied to these samples. This information was used to formulate a schedule of the average discount applied for various levels of infestation and the probability of receiving the discount. This schedule, in turn, was used to compare the economics of various pest control practices. Because detailed analysis of the two earlier surveys and the first sampling study are available elsewhere (12, 14, 20), only the most recent studies are discussed here, with reference to earlier studies where appropriate.

1991 PRODUCER SURVEY

Questionnaire

Questionnaires were sent to producers chosen randomly in a 1986 study (14). Details of the experimental methods for the survey and the characteristics of the respondents are given in Part I.

Disposition

Most respondents said that, in addition to farm-stored wheat, they delivered a sizeable proportion directly from the

In the 1990 experiments (16), all grain lots, regardless of insecticide treatment, were aerated. Three of eight lots (38 percent) to which no insecticide was applied required fumigation. This is a somewhat higher percentage than reported in Oklahoma (6), but most of the Oklahoma lots had been treated with protectant. The average cost of electricity for aeration in the 1990 trials was about 0.5¢/bu (24 lots). Obviously, if grain cooling could be made more timely and convenient, it would be a cost-effective insect control technique.

field to a local elevator (Fig. 8). One fourth (26.4 percent) claimed to deliver at least 90 percent to a local elevator at harvest time. Overall, about one-fifth (20.7 percent) kept 95 percent or more on the farm. A few (5.0 percent) also delivered wheat from the field to a terminal elevator. About three-fourths (88 of 121) of producers who said that they stored more than just their own seed wheat reported selling the stored wheat off-farm. The remainder apparently used all their farm-stored wheat, most likely in the form of livestock feed. Even those who indicated that they normally did not sell their farm-stored wheat responded to most of the marketing questions. In general, the responses of this group were not markedly different from those of other respondents.

Respondents that reported selling after farm storage included 26.4 percent who delivered the grain to country elevators and 20.7 percent who shipped to terminal elevators (Fig. 9). Certain producers delivered farm-stored wheat to feedlots or flour mills, and the majority of this group stored more than half their wheat crop on-farm. In contrast, producers who sold to neighbors or others tended to store smaller portions of the crop. Apparently, more than 18.0 percent of the annual harvest was consumed on-farm. A minority of respondents indicated that they delivered more than 90 percent of the crop to an elevator after farm storage. Four of these traded at country elevators, whereas nine dealt with terminal elevators.

Marketing Strategy

Clearly, many marketing strategies are used by Kansas producers who store wheat on-farm. In addition to those who store on-farm to speculate on price, some farmers fill their farm bins mainly to reduce the number of trips to the elevator during the busy harvest season. For others, the amount delivered at harvest time rather than later is based on landlord and sharecropper shares. Others store to delay farm income from one tax year to another. Still others have a specific market in mind, and store on-farm to preserve the identity of a lot having a specific quality for that special market. Those who store for certain terminal elevators or flour mills must preserve grain quality in order for their strategy to result in maximum profits. Others, such as those who store on-farm to delay farm income or for animal feed, may be less concerned about strict quality maintenance during storage.

Distance from the farm to the delivery point is a marketing consideration. Wheat delivered to elevators at harvest time is hauled shorter distances, on average, than that delivered from farm storage (Fig. 10). Ten times more respondents reported one-way trips of 30 miles or more after harvest (19.3 percent) than at harvest time (1.8 percent). The producers that constituted this 19.3 percent may have included those located far from the nearest elevator, as well as those whose marketing strategy was to keep a large portion of their crop on-farm for later sale at higher prices.

For most respondents, distance from the farm to the elevator was an important factor in the choice of where to sell their farm-stored wheat (Fig. 11). Nearly three-fourths (71.9 percent) indicated that the price offered was an important consideration, and 19.8 percent and 32.2 percent, respectively, indicated that price discounts or premium policies were considered. Less than 10 percent indicated that the amount of other types of business done at the elevator (because of “loyalty to” or “familiarity with”) was an important consideration, but 22.3 percent indicated that the quality of the wheat they had to offer was considered. This one out of five producers apparently sold to buyers for whom grain quality and price were related strongly. An example of this type of buyer is the flour miller, who typically offers higher prices than other buyers but accepts only grain that meets certain standards of protein and cleanliness. Other examples are certain terminal elevators, where prices are higher than at most local elevators, but where a strict set of quality discounts is enforced.

Many of the factors that the respondents said were important to them when choosing an elevator were dictated by the policies and/or practices of the grain dealer. Of course, distance to the elevator was not, but grain price (relative to other buyers) and price premiums were most important to producers choosing the outlet for their farm-stored wheat. Apparently, the possibility of price premiums, which are based on high protein or test weight, was important to more farmers than the likelihood of price discounts.

Price Discounts

More than half (56.4 percent) of the respondents said that they had received price discounts for poor quality wheat they delivered from farm storage. Of this group, more than two-thirds (68.2 percent) said the discounts were due to low test weight (Fig. 12). A third had received discounts for excessive impurities. Discounts for insect-related factors (presence of live insects or insect-produced odors or damage) were mentioned at about the same frequency (30.3 percent).

About one in five respondents who had received price discounts said that the discount was due either to live insects or insect damage. This is consistent with other Kansas studies indicating that insect-related quality characteristics are less often the cause of discounts than are test weight or purity factors. Ironically, test weight and impurities content are characteristics over which a producer may have little control in a given year, whereas insect-related factors can be controlled by proper storage management.

As reported by respondents, the value of the price discount for live insects ranged from 2¢ to 5¢ per bushel with a mean of 4.3¢/bu. When only the respondents who sold off-farm were considered, one-third said that the discount was 3¢/bu and two-thirds said that it was 5¢/bu. These costs can be compared with those of insect control measures, which, according to Reed et al. (16), were approximately 1.6¢/bu for the most effective grain protectant, 0.8¢/bu for fumigation, and 0.5¢/bu for cooling by aeration.

Price discounts are not the only type of penalty applied to low quality grain. Sometimes, the weight of the load is reduced to compensate for low quality. This practice is used most commonly to compensate for purity factors, which are reported as either dockage or foreign material (Table 4). According to respondents, this method is also applied commonly to compensate for low test weight, although other Kansas research has not often detected this practice. Respondents indicated that insect-related deterioration is penalized most often by reducing the price, as opposed to the weight. Whereas 58.8 percent who had been penalized for elevated levels of impurities said the penalty was applied as a weight reduction, only one in 10 respondents who had experienced penalties for live insects said the weight of the load had been reduced. Among all respondents who had experience with a quality-related penalty, 59.4 percent said it had been a price reduction, 29.0 percent said the weight of the load was reduced, and 11.6 percent reported both types of penalties.

Nearly two-thirds (62.9 percent) had received discounts at country elevators, 32.9 percent said that the discount had been applied at a terminal elevator, and 4.3 percent had experienced discounts at both types of businesses. Because the number of respondents delivering to country and terminal elevators was similar (26.4 and 20.7 percent) the larger proportion who reported receiving a discount at country elevators must indicate that a higher proportion of loads delivered to country elevators was discounted as compared to loads delivered to terminal elevators. This perception is not consistent with the results of Reed et al. (19), who showed a greater probability of discount at terminal than country elevators. Possibly, farmers tend to select their better-quality grain for on-farm storage and later sale. Thus, wheat of lower test weight may be sent at harvest time to country elevators, where it receives a discount, whereas more farm-stored grain of higher test weight is delivered to terminal elevators.

Perception of Discount Policy

Producers were asked to describe the policy toward grain containing live insects at the elevator or other business where they usually delivered their farm-stored wheat. About one-third of those who answered believed that the price of such grain was discounted (Fig. 13). A rather large number (12 of 121) did not answer the question. Combined with those who claimed not to know the answer, 35.5 percent of all respondents apparently did not feel confident giving an answer. This may be because they think they have never delivered infested grain. About 15 percent said that the policy was variable. When asked if the policy on insect-related quality factors was posted

in a public place at the site where they usually deliver farm-stored wheat, more than half (58.7 percent) declined to answer. Among those who gave a response, 46.0 percent said yes.

Even those who apparently were not familiar with the discount policy commented on its application. Nearly half of all respondents felt that a policy on insect-infested grain was applied (Fig. 14). Where policies varied, the variation was attributed to a number of factors, including the situation at the elevator (whether it had room to isolate infested grain; whether it had an abundance of good-quality grain into which deteriorated grain could be blended; etc.). A few respondents (3.3 percent) felt that whether a discount was applied depended on the client. Others felt that it depended on other things, and about a quarter felt that it depended on several factors considered together. Only one farmer reported that the quantity of infested grain delivered affected the likelihood or severity of a discount. Reed et al. (19) found that elevator managers felt that the quantity of infested or damaged grain was a major factor in the decision to discount or refuse the affected lot. This discrepancy appears to reflect a substantial difference between the perceptions of producers and those of grain dealers.

The 1988 changes in U.S. grain standards for wheat were expected to affect grain merchandizers' policies on accepting infested or damaged wheat. About a quarter (23.7 percent) of the respondents indicated that the value of discounts for infested or insect-damaged grain had increased during the past 3 years. Others (33.0 percent) said that, although discounts schedules had not changed, more attention was now paid to insect-related quality issues than previously. The rest did not know (8.2 percent) or had not noticed any change (35.1 percent). Twenty-four persons declined to answer.

Respondents were asked to indicate their agreement or disagreement with two general questions related to the cost of quality maintenance and how quality factors should be evaluated. With 22.3 percent abstaining, the majority (88.3 percent) of those who responded in 1991 agreed that the likely loss of income from price discounts was greater than the sum of costs incurred to maintain grain quality. In 1986, nearly half of the same respondents declined to answer the question, and 74.5 percent agreed with the statement. This is evidence that farmers were more cognizant in 1991 of issues surrounding the loss of grain quality during storage than they had been in 1986.

Twenty-one persons (17.4 percent) declined to indicate agreement or disagreement with the following statement: "If all elevator managers would follow a strict policy of discounting infested or insect-damaged wheat coming out of farm storage, it would be more fair to everyone and would help improve the quality of our grain." Of those who responded, 89 percent agreed.

Effects of Location

Respondents from western Kansas drove 30 percent farther ($p < 0.05$) than producers in central Kansas to deliver wheat to a local elevator at harvest time. The average distance

driven to deliver farm-stored wheat was similar for persons in western and central Kansas (29.4 and 24.2 miles, respectively). However, in western Kansas, the proportion delivered to country elevators was more than twice as great as in central Kansas. In other words, many producers in western Kansas drove as far to deliver to a local elevator as their central Kansas neighbors did to deliver to a terminal elevator. The proportion of farm-stored wheat delivered to terminal (as opposed to country) elevators was about 11 percent in both zones.

Interesting, though not statistically significant, trends by location also occurred in farmers' perceptions of discount policies for insect-related quality factors. Respondents in central Kansas were three times more likely than those in western Kansas to say that the handling of infested wheat depended on the situation at the elevator at the time of delivery. Also, nearly a third (30.4 percent) of respondents from central Kansas said that discount policies had not changed in recent years. Only 25 percent of respondents in western Kansas agreed. More respondents in western Kansas than in central Kansas (34.6 and 20.3 percent, respectively) said that elevator personnel now inspected more thoroughly than before the changes in U.S. grain grades.

1991 ELEVATOR MANAGER SURVEY

In 1986, managers of 85 randomly chosen country elevators in western and central Kansas were surveyed to determine their pest control practices and buying policies for wheat (17). U.S. wheat standards were changed in May 1988 to reduce the number of live insects from a maximum of four per 1000-g sample to one before the lot was designated "infested." In addition, IDK was recognized as a separate quality factor, with more than 32 IDK per 100 g causing the lot to be designated "sample grade." Using the 1986 data as a baseline, the 1991 study investigated the effects of these changes in wheat standards on the relationship between grain quality and price. The 1991 survey also collected more detailed information on the relationship between various marketing factors and the role of elevators as the first purchaser of farm-stored wheat.

Data Collection and Analysis

The 1986 list of randomly chosen elevator sites was used as the basis of the study. Details of the selection are given in Reed et al. (17). Between January and March 1991, elevator managers were interviewed by researchers who recorded the information on a standard questionnaire form. For purposes of the analysis, small elevators were those with a capacity of less than 500,000 bushels (13,500 t), medium-sized elevators had a capacity of 500,000 to 1,000,000 bushels (13,500-27,000 t), and large facilities had a capacity of more than 1,000,000 bushels (27,000 t). Geographic location was defined by the Kansas Crop Reporting Service districts (Fig. 1). With the exception of one county, whose responses were included in the southcentral district, eastern Kansas was excluded from the study by the selection procedure.

SAS software (21) was used to conduct t-tests of significance between means and to calculate frequencies and conduct chi-

square tests of association. Further details of the analysis are found in Worman et al. (25).

Differences between 1986 and 1991 Samples

Although the 1991 and 1986 studies used the same randomly chosen locations, 72 elevator managers were surveyed in 1991 compared to 85 in 1986 (Table 5). Elevators that had gone out of business (3 cases) or no longer handled farm-stored wheat (2 cases) accounted for almost half of this decline. Also, in 1991, only one interview was conducted with general managers of elevator chains where more than one branch manager had supplied the information in 1986 (4 cases). In 1991, fewer interviews were conducted at small elevators and more at large elevators, probably indicating that elevators have added storage capacity in the intervening years.

Business Environment

Previous studies appeared to indicate that policy relative to farm-stored wheat and the handling of infested or deteriorated wheat may be affected by the constraints and pressures of the local business environment. Therefore, several items in the questionnaire addressed business and competition issues. Managers were asked to rank several activities in order of importance to the income of the business. Factors to be ranked were grain merchandizing and storage, feed sales, fertilizer sales, sales of animal health products, sales of petroleum products, and others. Based on a weighted scoring system, grain merchandizing and storage were almost twice as important as fertilizer sales (Table 6). Feed sales were third, followed by petroleum products. Differences occurred among districts and regions in terms of order of importance. Feed sales were significantly more important to independently owned businesses.

We were interested in determining whether managers of elevators where grain storage and merchandizing contributed most of the revenues faced different operating situations or had different policies than managers of elevators where other activities were more important. To examine this, the sample was divided into a group for which grain storage and merchandizing were the most important (61 elevators) and a group for which some other activity produced more income (11 elevators). Elevators representing the first group were distributed over all districts, whereas 64 percent of the group for which grain storage and merchandizing were not the primary activities was located in the southcentral district. The west, southwest, and northcentral districts had no elevators in this latter group.

The grain storage and merchandizing group diverted 14 percent of its grain to animal feeds compared to 3 percent for the other group. Perhaps managers of firms that are primarily dependent on grain business have to accept some wheat of lower quality in order to obtain good quality wheat. They may then divert this lower quality grain to feedlots or feed mills. In contrast, managers of firms for which grain is of secondary importance may be in a position to refuse lower quality wheat.

Eighty-two percent of the group most dependent on grain storage used fumigation while turning grain to control insect infestations, compared to 55 percent for the other group, whereas the group more dependent on other activities tended to favor fumigation in the bin (36 percent compared to 15 percent). This may be partly due to the storage group having more storage capacity and, therefore, a greater capability to turn grain.

As estimated by the managers, the mean size of the trade area for all elevators was 17.3 miles in all directions, with a range of 5 to 120 miles (Table 7). The most common radius reported was 10 miles, and 25 percent of the elevators had a trade area of less than 9 miles. The median trade area had a radius of 12.5 miles, and 75 percent reported an area with a radius of 17 miles or less.

To determine whether managers of grain elevators with a smaller trade area responded differently on wheat quality issues than managers of elevators with a larger trade area, the elevators were divided into equal-sized groups, depending on whether their trade area was larger or smaller than 12.5 miles. The central and the southcentral districts contained most of the group with trade areas of 12.5 miles or less (38 percent and 35 percent, respectively), whereas elevators with the larger trade area were relatively well distributed among the districts.

Elevators with the smaller trade area reported having a mean of 3.4 grain merchandising and storage competitors within these trade areas, compared to 5.6 for the group with the larger trade areas. Likewise, the smaller-area elevators reported a mean of 3.6 fertilizer sales competitors compared to 5.2 and 3.8 petroleum competitors compared to 6.5. Elevators with the larger trade areas tended to have a large storage capacity, whereas elevators reporting a smaller trade area were predominantly small and medium-sized.

When managers of elevators in the two groups were asked to rank factors they considered when determining their discount policy, they ranked competition about equally. However, 67 percent with the smaller trade area reported that passing discounts on to producers (by charging producers the amount of discount they expected to receive when they shipped the grain) was their primary intention. Only 45 percent of the group with the larger trade area rated this as the primary motive for their policy. Because managers with small trade areas had fewer competitors, they may have been less concerned with competition than with maintaining their profit margins by charging the producers for any discounts they received. On the other hand, the managers working with smaller trade areas appeared to be more concerned with maintaining good customer relations, because twice as many were willing to adjust discounts depending on the circumstances. Managers with smaller trade areas also were more likely to vary discounts according to the amount of other business the farmer did with the elevator than were managers of elevators with larger trade areas.

Overall, branch operations reported significantly ($p < 0.05$) fewer competitors than did headquarters elevators (Table 8). Geographical location affected competition, with managers of elevators in the northwest and west districts reporting more competitors in grain merchandising and storage than did those

in the central district. Large elevators had more competition in fertilizer sales than small elevators and more competition than either small or medium elevators relative to petroleum products.

To determine whether greater competition for grain influenced the policies and practices of elevator managers, we divided the elevators according to the median number of competitors (median = 3) for grain storage and merchandizing. Thirty-one managers had an average of 2.2 competitors (range 0 to 3), and 39 managers had an average of 6.4 competitors (range 4 to 15). Central-zone elevators dominated the group with fewer competitors (85 percent), whereas the group with more competitors was dispersed equally within western and central Kansas. The group with more competitors in the grain business also had more competitors in the fertilizer sales business (5.5 compared to 2.7), in the animal feed business (4.9 compared to 2.5), and in the animal health business (4.5 compared to 2.4).

The group with fewer competitors shipped 64 percent of its wheat to other elevators, compared to 38 percent from the other group, whereas the managers from the group with more competitors shipped almost twice as much of their wheat to flour mills (48 percent compared to 29 percent). This may be because 67 percent of the elevators with a smaller number of competitors were branches, whereas the 62 percent of the elevators with more competitors were headquarters. The branch operations may have been shipping to their headquarters elevators, where the grain was marketed. More than four times as many of the group with less competition changed ownership between 1986 and 1991, perhaps because several of the larger cooperatives acquired branches during this period.

The number of competitors appeared to be related to certain policy and procedural differences between elevators. No manager of elevators with the smaller number of competitors examined grain for IDK at harvest time, whereas 18 percent of the managers with more competitors determined IDK at harvest. Also, 79 percent of the elevator managers in the group with fewer competitors submitted samples for official grade, whereas 95 percent of the other group submitted samples.

Procurement of Farm-Stored Wheat

Managers reported receiving farm-stored wheat from an average of 24 farmers (range 2-30) (Table 9). The surveyed elevators purchased an average of 68,444 bushels (1850 t) of farm-stored wheat per year, with a range of 1,000 to 660,000 bushels (27-17,850 t). Three-fourths of the managers reported purchasing 65,000 bushels (1760 t) or fewer from 17 or fewer farmers per year. Headquarters elevators tended to receive farm-stored wheat from a greater number of farmers than did elevators that were branch operations. The quantity of farm-stored wheat handled was greater in the north than in the south (Fig. 15), perhaps because a larger proportion of the farm-stored wheat was going directly to feedlots in the southwestern district. In the southcentral district, farmers can easily ship directly to nearby terminal elevators. Managers of large elevators reported buying significantly ($p < 0.05$) more wheat from farm storage than those at small elevators.

The average overall quantity of farm-stored wheat received each year represented 9 percent of the elevators' storage capacity (Table 9). Managers of headquarters elevators reported receiving more than twice as much of their storage capacity from farm storage as did branch managers. Elevators in the north and central regions also received more than twice as much from farm storage, relative to their capacity, as did elevators in the south region. This is consistent with the 1986 survey, which showed that large elevators, elevators in the south region, and those in the southwest district all had less storage capacity occupied by farm-stored wheat.

Destination of Wheat

Managers indicated that, on average during the preceding year, they shipped 49 percent of their wheat to other (terminal) elevators, 39 percent to flour mills, and 12 percent to feedlots or feed mills (Table 10). The amount of wheat shipped to other elevators was smallest in the west and southwest districts, where more of the wheat was destined for animal feed. This disposition pattern held between zones, with elevators in the western zone shipping more wheat for animal consumption, whereas central-zone elevators shipped more wheat to other elevators. Wheat was about twice as likely to be shipped to other elevators from small than from large elevators.

A comparison of the 1986 and 1991 survey results indicated a reduction from 76 percent to 49 percent in the amount of wheat shipped to other elevators. The quantity shipped to flour mills increased from 17 percent to 39 percent and shipments to feedlots and feed mills increased from 6 percent to 12 percent. The increase in shipments destined for animal feed can be explained by the relative prices of wheat and corn in 1991. The decrease in shipments to other elevators probably reflects a reduced export market. In 1986, grain stored under long-term contracts was being exported with the assistance of the Export Enhancement Program. By 1991, this reserve stock was generally depleted, and elevators contained only grain purchased during that year. Medium-sized elevators and western-zone and central-region elevators showed the greatest shifts away from shipments to other elevators. Medium-sized and western-zone elevators shipped more animal feed in 1991 than in 1986, whereas central-region elevators increased shipments to flour mills.

Fifty-four percent of the surveyed elevators had a feed mill associated with the operation. Cooperatives were nearly twice as likely to have a feed mill as independent elevators, probably because many independent elevators are owned by major companies and function mainly as grain collection points for the owner's terminal or export facilities. Headquarters operations were more than twice as likely as branch operations to have an associated feed mill.

Sampling Practices at Harvest Time

Wheat arriving at an elevator usually was sampled to determine its quality. During the busy harvest season, fewer loads from a particular source were sampled than after harvest. Managers were asked what quality factors they consider when

sampling wheat received at harvest time. For this item, the interviewer recorded only the answers volunteered by the respondent. All respondents indicated that they measured test weight, 97 percent determined moisture content, and 75 percent measured dockage. Dockage was slightly more likely to be tested at independent operations, at branches, and at small elevators and was tested at all surveyed elevators in the western district. Also, cooperatives in the central region and central zone generally tested for this factor. Some chains had installed dockage-testing equipment at all branches. Managers at these sites said that they were sampling all loads and determining price based on dockage content.

No respondent reported checking for rodent pellets in wheat received at harvest time. Ten percent or less examined the sample for foreign material, shrunken and broken kernels, damaged kernels, IDK, or odor. Eighteen percent monitored for live insects, with significantly more managers of cooperatives monitoring this factor. Other factors, such as weeds, seeds, rye, "pink" (seed-treated) wheat, or soft wheat, were determined at 14 percent of the elevators.

In 1986, dockage and/or foreign material were determined at harvest time at 52 percent of all elevators, whereas, in 1991, dockage was measured at 79 percent of the sites. The number of elevators sampling for live insects in wheat received at harvest also increased from 2 to 18 percent.

Sampling Practices at Receipt of Farm-stored Wheat

Because farm-stored wheat has a greater likelihood of containing insects, and because it usually is delivered to elevators during slack work periods, managers reported that virtually all loads of farm-stored wheat were sampled when they were received. The same factors considered by managers in sampling at harvest time, i.e., test weight, moisture, and dockage, were considered when sampling wheat that arrived from on-farm storage. In addition, 89 percent checked for live insects, and 61 percent reported that they determined IDK. A major difference in examination of the sample for live insects occurred between districts, with all elevators in the west and southwest districts testing for insects, whereas only half of the elevators in the northwest district did so. Elevator operators in the north region looked for live insects less often than did managers in the central and south regions, but northern managers screened for IDK more often than did managers in the other regions. The reason for this difference in testing for live insects and IDK is not apparent. One possible explanation is that regional or individual differences exist in colloquial definitions of quality-related terminology. For example, "buggy wheat" might indicate sound grain with a light infestation or might refer to insect-damaged grain whether or not live insects were present. Factors that were monitored at 10 to 25 percent of the elevators included protein, damaged kernels, rodent pellets, and odor.

The numbers of elevators monitoring test weight, moisture content, and objectionable odor in wheat received from on-farm storage remained virtually the same between the 1986

and 1991 surveys. During this period, the proportion of elevators testing farm-stored wheat for dockage and/or foreign material increased from 58 percent to 83 percent, the proportion examining for live insects increased from 68 percent to 89 percent, and the number checking for rodent pellets nearly doubled. Overall, this indicates that Kansas grain dealers felt they had increased their vigilance relative to contaminants in farm-stored grain.

Types and Amounts of Discounts

Seventy-five percent of the interviewed managers reported their discounts for live insects. Of the remainder, four managers refused to handle infested wheat, four did not know or would not provide the information, and the others used official grade or other methods for pricing. Discounts ranged from 0 to 10¢ per bushel, with 46 percent discounting 5¢ per bushel. The average discount was 4.4¢ per bushel (Table 11). Substantial differences existed in discounts for live insects based on location, with the mean for northwestern elevators being significantly ($p < 0.05$) lower than that for other districts (Fig. 16).

The value of the price discounts reportedly applied for insect infestation was significantly ($P < 0.01$) lower in 1991 (4.4¢/bu) than in 1986 (5.3¢/bu), although the pattern across geographical areas was generally the same. This reduction may have been a reflection of the better overall wheat quality in 1991. Managers tend to discount for insect presence less severely if test weights and other quality characteristic are superior. Although a decrease occurred in the mean reported discount, the most commonly used discount increased from 4¢ to 5¢, and a normalization occurred about this mode (Fig. 17). In 1986, nearly a third of the managers reported discounts extremely different from the mode, whereas in 1991, fewer managers reported very low or very high discounts. This may indicate that managers are tending to be less variable in their perception of infestation as a quality factor.

Sixty-four percent of elevator managers reported discounting for IDK. Five elevators had fixed discounts of 5, 10, or 15¢ per bushel, and a discount schedule ranging from 3¢ to \$1.50 per bushel, depending on amount of IDK, was used at 15 sites. At 10 elevators, a weight discount ranging from 1 to 10 percent was used, with five of those reducing weight by 1 percent for each IDK. Ten managers determined the discount "based on state grade," one based the discount on the terminal discount, and five limited their purchases of grain containing more than 32 IDK per 100 g to feed.

Forty-nine percent of the managers reported discounting the price of wheat containing a commercially objectionable foreign odor (COFO). Twenty-three managers discounted an average of 7.6¢ per bushel, with 11 discounting 10¢, and 9 discounting 5¢ per bushel. At one elevator, the discount was 2 percent by weight. Other managers said that they "did not handle" (4), applied a "variable discount" (2), "purchased for feed only" (2), "used state grade" as the basis of price (1), or "settled after terminal discount was known" (1) when wheat containing COFO was offered. Seven percent of the managers reportedly discounted for dead insects or insect fragments,

with discounts ranging from 0.5¢ to 10¢ per bushel. Fourteen percent of the elevator managers said that they occasionally discounted for other factors, including heat-damaged grain and bird droppings.

Changes in Country Elevator Discount Policies

Managers at 64 percent of the sites reported that their discount policy for insects in farm-stored wheat had changed during the 1988-90 period. Of the 45 managers reporting policy changes, 44 indicated that policies were made stricter. Seventy-five percent indicated that the policy change had occurred after the change in grain grading standards in 1988.

The most common change, mentioned by 39 percent of the 45 managers reporting a change, was to apply the same discount schedule as previously, but to sample and inspect the grain more carefully and apply discounts more often. Twenty-seven percent of the managers indicated that they used greater discounts applied more often after the change, and 14 percent used greater discounts applied about as often as previously. More than half of the producers surveyed in the same year reported that they perceived a change toward stricter policies at their local elevators (see page 12, Perception of Discount Policy). Other managers said the revised policy included rejecting wheat with “high” IDK, adjusting their policies “up to the new standard”, “passing on” discounts received from terminal elevators, or discounting at a “lower” IDK. About one-quarter of these changes was reported in each category by managers of headquarters operations, whereas branch managers tended to respond that the same discount used previously was applied more often after the change (55 percent) or that greater discounts were applied more often (32 percent). This difference may indicate that branch managers have had less flexibility and were being brought into compliance with policies of the headquarters units.

Producers’ Responses to Changes in Discount Policy

Elevator managers perceived a number of reactions from farmers to the changes in discount policy for infested farm-stored wheat. Forty percent indicated that farmers were more careful with farm-stored wheat, whereas 29 percent indicated that farmers stored less on-farm. Although 13 percent of the managers said that farmers have accepted the stricter standards, 11 percent reported that farmers “complain a lot about the situation, but have changed little.” Nine percent of the managers indicated that farmers look for a more lenient place to sell, including elevators and feed yards without discount policies. A like number of managers reported that farmers manage their farm-stored wheat better, with information provided by the elevator staff.

Nearly half of the managers who reported a change in policy during the previous 3 years indicated that the change had caused the elevator to lose customers and sales. Thus, the fear expressed by managers during the 1986 interviews that they would lose customers if they instituted a stricter discount

policy appears to have been realized. The loss of customers was reported most often at cooperatives, at medium-sized elevators, and in the northwest and west districts.

Also, in 1986, the majority of managers felt that discounts applied against them at terminal elevators were more severe than those they charged their clients. In 1991, several of the managers reported that terminal elevators would accept wheat from farmers without discount but would have discounted the same wheat had it originated from a country elevator. Some managers felt that this double standard undercut the efforts of country elevator managers to increase grain quality through discounts for low quality. This perception was not confirmed by the findings of the 1986-87 and 1990-91 discount studies, which indicated a greater likelihood that infested farm-stored wheat would be discounted at terminal elevators than at country elevators.

Determining and Applying Discount Policy

Managers were asked to rank the factors they considered when establishing their discounting policy. The factors were characterized as competition (match or beat the competition in their trade area), pass on discounts (charge the producer the discounts received at terminal elevators and mills), average wheat quality (the average quality of farm-stored wheat in the area), and other factors. A weighted scoring system indicated that passing on discounts was the most important factor overall, followed by competition and average wheat quality (Table 12). Competition was significantly more important at large elevators, whereas passing on discounts was significantly more important at cooperatives and medium-sized elevators. This finding contradicts the conventional wisdom that small operators are more concerned about competition than are managers of larger elevators. Possibly, the latter group, which can no longer rely on income from government-financed storage programs, may be competing more aggressively with smaller elevators for storage revenue. At small and medium elevators, a large portion of the capacity may be filled each year with local wheat. Therefore, managers may be more concerned with passing on any discounts they may receive from terminal elevators, in order to protect their profit margin.

Sixty-six percent of the managers indicated that their discount policy for stored-grain insects was applied equally for all customers, whereas 34 percent indicated that they varied the policy according to the circumstance. The proportion of managers who indicated that they applied their discount policy in a standard manner, i.e., the same for everyone, decreased from 84.5 percent in 1986 to 66 percent in 1991. Managers who were stricter in looking for insect problems, who had begun to consider IDK, and who had recently increased discounts, may have felt that they had to be more flexible with certain customers and, thus, may have been more likely to adjust their discount policies. Alternatively, managers may have paid less attention to the quality issue prior to 1988 and were able to respond more accurately in 1991.

Managers who varied their discounts were asked to rank several factors that they might consider in adjusting the discount policy. These factors were: elevator circumstances

(whether space for isolating the lot was available, whether enough good quality grain was available for blending); amount of grain business the customer brought to the elevator; amount of nongrain business the customer did at the elevator; and other factors. Based on a weighted scoring system, elevator circumstances and the amount of grain business provided by the customer were of equal importance, followed by the amount of other business the customer represented (Table 13). The amount of grain business done with the farmer was more important for cooperatives, whereas the amount of nongrain business was more important to independents.

Infested Wheat from Farm Storage

In 1991, a few more respondents indicated that they were likely to refuse wheat containing insects or a small amount of IDK than did so before the change in grading standards. Eighty-nine percent of managers who accepted infested wheat said that they fumigated the grain before storage in order to reduce possible contamination of other stored grain. This was a reduction from the 93 percent in 1986 who indicated that they fumigated and stored infested grain. However, in 1986, wheat received from farm storage was not likely to have been stored very long after receipt. More than half the managers indicated that they changed their practices concerning the handling of grain received from farm storage after the 1988 change in grading standards. An additional 15 percent indicated that they were more aware of insects.

The major effect of the 1988 changes in the U.S. wheat grades was to make IDK a specific grading factor. Consequently, managers now appear to be more aware of IDK problems and have made major changes in their approach to handling IDK. Forty-seven percent of interviewed managers indicated that they refused wheat with high IDK, whereas 10 percent fumigated high IDK wheat and kept it separate for feed use. Of those managers who defined high IDK, 14 considered 32 IDK/100 g as high, whereas 1 each considered 20 and 30 IDK as high. Thirty-two or more IDK per 100 g causes a sample to be graded "Sample Grade."

In 1986, 15 percent of managers refused wheat that was insect-infested. By 1991, 47 percent reported refusing wheat with a high IDK. The method of handling infested wheat that was accepted into the elevator did not change, although the number of elevators receiving infested wheat for feed uses increased slightly in 1991.

Perceived Changes in Terminal Elevator Discount Policy

Three-quarters of the elevator managers perceived that the discount policies of terminal elevators to which they shipped wheat had been modified in the previous 3 years. All of the managers thought the discount policies were stricter in 1991 than in 1986. Eighty percent reported that the change had occurred in 1988, with the remainder reporting that the change had occurred in 1989.

Managers were asked if buyers specified insect-free wheat in sales contracts. Forty-six percent indicated that certain

buyers did so. Twenty percent of elevator managers (primarily branch managers) did not know the content of sales contracts, because they did not merchandize grain. Managers of headquarters elevators were almost twice as likely to report sales requiring insect-free wheat than were branch managers. The percentage of managers who indicated that buyers required insect-free wheat increased from 20 percent in 1986 to 46 percent in 1991.

Perceived Changes in Flour Mill Discount Policy

Of the 69 managers responding, 43 percent had perceived a policy change relating to insects within the previous 3 years at flour mills to which they shipped wheat. Nearly one-quarter of the respondents had not perceived a change in policy, 12 percent did not ship to mills, and 22 percent did not know. All who had perceived a change thought that the policy was stricter after 1988, and 26 of the 30 managers perceiving a change reported that it had occurred in 1988.

Premiums

Thirty-two (44 percent) of the managers indicated that they offered premiums for high-quality wheat. Over half of the large elevators provided premiums compared to less than one-quarter of the small elevators. Seven managers said that they offered premiums for more than one factor. Of the managers who offered premiums, 69 percent reported a premium for high-protein wheat, 34 percent for high test weight wheat, and 9 percent for low dockage wheat.

1991 SAMPLE STUDY

The surveys described producers' and elevator managers' perceptions of various aspects of the relationship between the quality of farm-stored wheat and its price. In order to objectively examine the relationship between wheat quality and discounts, sample studies were conducted in 1986-87 and 1990-91. Selected elevator managers retained samples of wheat from producers' loads as they were received from farm storage. Kansas State University investigators retrieved these samples and analyzed them. Information about the sample, whether a discount was applied, and the amount and reason for the discount was supplied with each sample. Analysis of the results indicated which quality factors were discounted, the average amount of the discount, and the probability of receiving the penalty. Further details of the experimental methods are found in Reed et al. (19).

Samples

Nine country and five terminal elevators cooperated in the 1991 study and supplied 249 samples, representing 239,000 bu (6,500 t), between November 1990 and May 1991. The 1986 study was larger, consisting of 11 country and six terminal elevators that supplied 465 samples. In both studies, most samples were supplied by the terminal elevators, reflecting their much larger trade in farm-stored wheat. In 1991, 88

percent of the samples contained no insects, 8 percent contained less than five insects, and 4 percent contained more than five live adult insects. The infested samples represented one-quarter of the grain on a weight basis, similar to the 25.9 percent in 1986.

Probability of Discount

Wheat with samples containing insects was about twice as likely to be discounted as was wheat with insect-free samples (Table 14). More than one-third of the infested samples were not discounted, which was the same as in 1986. Compared with low test weight, the presence of insects, even large numbers, was less likely to result in a price penalty. All lots weighing less than 58 lb/bu were discounted, whereas 70 percent of samples containing five or more insects were discounted. This corroborates surveys wherein producers indicated that price discounts received at elevators are more likely to be for low test weight than for storage-related factors. The message from the market appears to be that low test weight always will be penalized but the presence of insects may not. This was similar to 1986 results. The presence of dockage also was associated with a greater likelihood of a price discount, but there were no indications that discounting behavior relative to dockage content had changed between 1986 and 1991.

Whether the wheat is delivered to a country or terminal location appeared to affect the likelihood of a discount for storage-related quality factors. In both studies, the probability of a price discount depended upon the number of insects in the grain sample at terminal elevators, but not at country elevators. Based on the 1991 samples, none of the four infested lots delivered to country elevators had received a price discount, whereas the price of 19 of 26 infested lots delivered to terminal elevators was discounted.

Value of Discount

The discounts ranged from 0.4¢/bu to 77¢/bu, but most (51 percent) were 1¢ or less per bushel. Most of the smaller discounts probably were related to test weight, as opposed to insect presence. In 1991, price discounts for field-related quality factors (test weight, dockage) tended to be smaller than

in 1986. Among all samples weighing less than 58 lb/bu in 1991, 61 percent were discounted 3¢/bu or less, whereas in 1986, the majority of low test weight lots received a discount of more than 3¢/bu (Fig. 18). Similarly, most samples with less than 1 percent dockage received a small discount (<1.0¢/bu) in 1991, whereas in 1986 only 33 percent or 28.7 percent received a small discount, depending on the dockage content. This was probably a result of the overall superior quality of the 1991 crop.

Based on farmers' and elevator managers' perceptions, we expected higher discounts to be applied more often in 1991 than previously for storage-related factors such as infestation. This was not true. In 1986, most samples containing > 6 insects per 1000 g received a discount in the most costly range, whereas in 1991, most received a smaller discount. Among moderately infested samples in 1991, 60 percent received the lowest discount compared with half that number in 1986. These results refute the claim that penalties for infestation in farm-stored wheat became greater or were applied more often after changes in the U.S. wheat standards.

In 1991, the average discounts attributable to insect presence in all samples were 3.1¢/bu for five or fewer insects and 3.6¢/bu if more than five insects were present. These discounts were calculated by first determining the average discount applied within a test weight and insect density range. Then the mean discount applied against samples containing no insects within a test weight range was subtracted from the discount applied against samples within that range containing either 0.1 to 5 or more than 5 insects per 1000 g. This procedure separated the effect of insect presence from that of test weight or a combination of other quality factors. Because 60 percent of lots with one to five insects and 70 percent of lots with more than five insects present were discounted, average probable discounts of 1.9¢/bu and 2.5¢/bu were calculated for the insect density ranges of one to five and more than five, respectively. This is not markedly different than in 1986.

Overall, these studies show that awareness and concern about the wheat quality factors that may be affected by farm storage increased in 1991. This was true for producers as well as grain traders. However, the penalties for infested wheat and, therefore, the price signal from the market to the producer had changed little.

IV. WHEAT STORAGE PRACTICES AND CONDITIONS AT ELEVATORS

When these studies began, little information had been published about the storage practices at commercial elevators. Interview studies in Minnesota (2) and South Dakota (10) had focused on the handling of farm-stored grain, and the only previous Kansas study had been done in the mid-1950's. Certain information was common knowledge, such as that turning (moving grain from one bin to another) was a standard grain-conditioning technique. Turning allowed sampling and fumigation to take place and had a mixing and cooling effect that was thought to assist in quality maintenance. But more information relative to pest control practices and their effectiveness in elevator-stored wheat was necessary.

In 1986, 28 counties were selected randomly from all Kansas counties that traditionally were major wheat producers (Fig. 1). Then 85 sites were chosen randomly from lists of commercial elevators (17). Interviews were conducted and recorded on a standard questionnaire, and data were analyzed with SAS software (21).

The results showed that farm-stored wheat was typically held for a shorter time in the commercial facilities than was wheat received at harvest time. Significant differences were demonstrated between areas of the state relative to business and quality maintenance practices. For example, managers of elevators located in the northern part of the state typically

handled more farm-stored wheat, used rail transport more, were more likely to fumigate in-bin, and shipped less wheat directly to flour mills than did elevators located farther south. The routine use of grain protectants was reported more often in western than in central Kansas.

Size and type of ownership appeared to influence pest control practices. For example, independently owned operations more often hired commercial fumigators than did cooperatively owned businesses. At larger elevators, fumigation of wheat tended to be done only when an infestation was discovered, whereas at smaller elevators, wheat intended for long-term storage often received a prophylactic fumigation. The managers' estimate of the cost to turn grain was higher for larger elevators than for smaller facilities.

We expected that the 1988 change in U.S. grain grading standards and a concurrent demand from the baking industry for lower insect fragment counts in flour would affect policies and pest control practices at grain elevators. Therefore, a survey of elevator managers was undertaken in 1991.

1991 INTERVIEW SURVEY

Survey Techniques

The sample used for this survey was the same one used in the 1986 study. Between January and March 1991, 72 elevator managers were interviewed, when possible at their place of business, by one of two Kansas State University researchers. Interviewers recorded responses on the standard questionnaire form.

Elevators were classified by ownership, by their organizational level, and by the amount of registered storage capacity. Small elevators were those with a capacity of less than 500,000 bushels (13,500 t), medium-sized elevators had a capacity of 500,000 to 1,000,000 bushels (13,500-27,000 t), and large facilities had a capacity of more than 1,000,000 bushels (27,000 t). Geographic location was defined by the Kansas Crop Reporting Service districts (Fig. 1) Responses from one county in eastern Kansas were included with those of the southcentral district.

SAS software (21) was used to test for differences between means, to calculate frequencies, and for chi-square tests of association. The following results and discussion are based primarily on differences among these classification factors (25). Where appropriate, comparisons are made with the 1986 findings reported by Reed et al. (17).

Survey Sample

Seventy-two elevator managers were surveyed in 1991 compared to 85 in 1986, a 15 percent decrease (Table 15). Elevators that had gone out of business (3 cases) or no longer handled farm-stored wheat (2 cases) accounted for almost half of this decline. Also, in 1991, only one interview was done with the general manager of chains for which several branch managers had supplied the information in 1986 (4 cases). Also, fewer interviews took place at small elevators and more at large elevators, probably indicating that elevators had added

storage capacity since 1986. Twenty-eight percent of the 257 elevators in the counties where surveys were conducted were sampled.

Ownership or level of operation was not associated with geographic location. However, the capacity of the elevator was significantly related to location. This made it impossible to determine whether certain differences were the result of differences in geographic location or in size of elevator.

Changes in Ownership and/or Management, 1986-1991

Of the 72 elevators, 12 percent changed ownership during the 5 years between surveys. Cooperatives and branches were most likely to have changed ownership, and the west district had no changes in ownership. During the same period, 37 percent of the elevators changed managers. Of the nine elevators that changed ownership, four did not change managers. Independently owned businesses were more likely to have undergone a management change than were cooperatives. Significantly more branch elevators changed managers (49 percent) than headquarters elevators (26 percent) during the 5 years. No recorded change in management occurred in the west district, whereas the northwest district had a 50 percent change in managers. Small elevators also had a 50 percent change in managers and a 20 percent change in ownership. During the 5 years, an annual average of 7.4 percent of the elevators changed managers, which appears to indicate that training is often required within the Kansas grain industry.

Storage Capacity

The average storage capacity for selected elevators was 1,014,000 bushels (27,400 t), with a range from 50,000 to 5,178,000 bushels (1,350-140,000 t) (Table 16). The average storage capacity of small elevators was 290,000 bushels (7,840 t), that of medium-sized elevators was 723,000 bushels (19,500 t), and that of large elevators was 1,743,000 bushels (47,100 t). The selected elevators from the southwestern district were twice as large, on the average, as elevators in other parts of the state, and those in the western zone had significantly greater capacity than elevators in the central zone.

Long-Term versus Short-Term Storage

Because several questionnaire items referred to strategy for "long-term storage" as opposed to "short-term storage", elevator managers were asked to define "long-term." The average period that the 48 managers who answered the question considered to be long-term was 9.3 months, with a standard deviation of 6.2 months and a range of 2-36 months. Twenty managers indicated that they considered 12 months to be long-term, whereas 50 percent considered 9 months or fewer to be long-term. Thus, little consensus was seen among Kansas grain handlers relative to the meaning of long-term storage.

Use of Protectants

Thirty-one percent of the elevator managers surveyed said that they applied a chemical protectant (Reldan® or malathion) to the wheat they stored. Almost half of the headquarters-level managers applied a protectant, significantly ($p < 0.05$) more than the 14 percent of branch managers doing so. Of the 22 managers who applied a protectant, 23 percent applied it to all stored wheat, and another 23 percent applied the protectant only to long-term storage. An additional 18 percent applied the protectant to flat storage. The percentage of managers applying a chemical protectant rose slightly from 1986 to 1991 (25 versus 31 percent).

Treating Wheat Infested in Storage

Seventy-eight percent of the managers said that when wheat became infested in storage, it was fumigated while turning it into another bin. Another 18 percent chose fumigation in the bin, and 4 percent used other methods. Managers in the north and those managing small elevators reported significantly ($p < 0.05$) more in-bin fumigation (Table 17). Managers of cooperatives and headquarters units were more likely to fumigate while turning, possibly because they had more handling speed and available space to turn grain at their larger facilities. The percentage of managers relying on fumigation while turning remained virtually the same between 1986 and 1991. Eight elevator managers used more than one method of treating infested grain, including aerating or blending.

Fumigation Practices

Sixty-eight percent of respondents indicated that they fumigated only when an infestation was detected, whereas 50 percent indicated that fumigation was done on a predetermined schedule. Obviously, both types of fumigation were practiced at certain sites, depending on whether the grain was stored in upright or flat stores. Eighty percent of the 39 managers who reported that they fumigated when insects were found indicated that this strategy was applied to all wheat. Another 8 percent applied this strategy only to short-term storage, and 6 percent applied it only to upright storage. In contrast, 47 percent of the 36 managers fumigating on a predetermined basis treated all wheat this way, whereas 33 percent said it applied only to long-term storage.

Commercial pest control operators were contracted for all fumigations at 18 percent of the sites, whereas 14 percent of the managers used elevator personnel for fumigating upright storage and commercial pest control operators for flat storage. Some fumigation was carried out by elevator personnel at 61 percent of the surveyed elevators. The use of commercial pest control operators by small elevators for part or all of their fumigating was virtually unchanged between 1986 and 1991. However, cooperatives and medium-sized elevators reported more reliance on commercial operators in 1991 than in 1986.

Sampling of Outbound Wheat Shipments

According to respondents, most outbound shipments, with the exception of shipments moving between units of the

same organization, were sampled officially at either the point of origin (e.g., the country elevator) or at the destination. Most respondents said that they had official samples taken at the point of origin for rail shipments, whereas truck shipments were sampled for analysis in-house at the point of origin and official sampling was done at destination. The pattern of where official samples were taken may be partly due to tradition, but also to the smaller amount of grain and, hence, the smaller risk, represented by each truck shipment. Ninety-one percent of the 64 elevator managers who indicated that they shipped wheat by rail sampled all shipments, with only 3 percent not sampling rail shipments at all (Table 18). In contrast, 23 percent of the 70 interviewed managers who shipped by truck indicated that they did not sample outbound loads, whereas 47 percent sampled all truck shipments. Considerable variability existed in sampling patterns by geographic location for truck shipments, but much less for rail shipments.

Of the managers surveyed, 11 percent submitted samples of truck shipments for official grade, whereas 64 percent conducted some type of in-house analysis. Ninety-six percent of the managers conducting an in-house analysis of truck shipments measured test weight, and 80 percent determined moisture. Slightly more than half said that they inspected for live insects, whereas one-third measured dockage. Odor and IDK were checked by less than one-quarter of the managers, and 13 percent determined the damaged kernel content. More than one-quarter of the managers of large elevators inspected for damaged kernels, whereas only 7 percent of small-elevator managers and no medium-sized-elevator managers measured this factor. This difference may reflect variability in the level of training, experience, or sophistication among businesses of different sizes.

Eight of the surveyed elevators did not have rail facilities. Of those that had rail transport available, 89 percent submitted samples from rail shipments for official grade. At nearly all cooperative elevators, samples were submitted for official grade, whereas only three-quarters of the independent operators did this. Fewer managers of small elevators submitted samples than managers of medium-sized and large elevators. At only four elevators did the manager report conducting an in-house analysis of wheat being shipped by rail.

At 88 percent of the surveyed elevators, managers submitted samples for official grade. Of this group, only 70 percent of small elevator managers submitted samples, whereas more than 90 percent of the managers of medium-sized and large elevators submitted samples. Samples were submitted for official grade on all rail shipments at 79 percent of elevators from which samples were submitted. In addition, 6 percent of the respondents said that they submitted samples for official grade from all rail and truck shipments, and 14 percent submitted samples from some shipments. In 1986, only 54 percent of the elevator operators interviewed reported submitting samples for official grade. The increase was particularly apparent in the southern region, where the percentage of managers submitting samples for official grade increased from 29 to 82. The increased use of official

inspections appears to confirm that wheat quality factors are more important for wheat marketing in 1991 than in 1986.

SURVEY OF GRAIN-STORAGE EQUIPMENT AND PRACTICES

A separate group of Kansas State University researchers surveyed grain storage facilities and practices at Kansas elevators in 1989. Harner and Higgins (8) randomly selected 425 elevator sites to receive a self-answer questionnaire, 25 percent of which were returned and used in the following analysis.

They reported that 66 percent of the commercial storage capacity consisted of upright concrete silos. The mean capacity per silo was 22,900 bu (619 t), and 76 percent were equipped for aeration. The average fan had a 14 HP motor and was connected to three silos. More than half the fans had motors in the 10 to 15 horsepower range. On the average, surveyed sites had 1 fan horsepower for every 4,200 bu of capacity in concrete silos. Nearly half the respondents said that they typically stored wheat for 10-12 months in this type of silo, but 40 percent said that they usually stored wheat for a shorter period of time.

Cylindrical metal bins constituted 21 percent of the commercial storage capacity. More than two-thirds of the surveyed sites had this type of structure. The average capacity per bin was 36,670 bu (991 t), and the average number of bins per site was nine. Less than half these structures were equipped for aeration, and 75 percent of the fans had motors of 5 horsepower or less. Overall, respondents reported a mean of 3,500 bu per fan horsepower in metal bins. The length of storage tended to be shorter in metal bins than in concrete bins.

The remainder of the storage capacity consisted of flat stores, which were present at 34.8 percent of the surveyed sites. The mean capacity per store was 209,700 bu (5670 t), and the average site had 307,300 bu of storage capacity in flat structures.

Several types of chemicals reportedly were used for wheat at the surveyed elevators. Two-thirds of the managers reported using bin spray when cleaning and preparing bins for refilling, and most reported using fumigants in wheat. Of those that fumigated wheat, two-thirds said that they typically fumigated more than half of all wheat, most often between August and October. The most popular fumigant was phosphine, used at 87.2 percent of the surveyed sites. Chloropicrin use was reported by 5.8 percent of the managers, and 7.0 percent said that methyl bromide was used.

Not all respondents reported having equipment to monitor grain temperature. Nearly two-thirds (63.6 percent) reported that they had permanent cables read by portable units, whereas 14 percent of the systems consisted of permanent cables attached to a stationary monitor with print-out capability. Grain temperatures were monitored weekly at 60.6 percent of the sites, whereas 18.2 percent monitored grain temperatures on a monthly basis.

As expected, most respondents reported turning grain as a pest control measure, most often to reduce temperature and/or to facilitate fumigation. Half (52.4 percent) reported turning

wheat once in a typical year, whereas 38.1 percent said that they typically turned wheat twice or more. Two-thirds of the respondents also reported aerating stored wheat. Of those, 42.7 percent used two aeration cycles, and 39 percent used three or more cycles. Approximately equal numbers of respondents began aeration immediately after harvest or waited for cooler ambient temperatures. More than half (54.9 percent) said that they aerated continuously, whereas 35.4 percent said that they aerated at night only. More than half said that they stopped aeration if the relative humidity became too high, if the ambient temperature became too high, or if a storm was approaching. In general, elevator managers appeared more confident of their ability to manage aeration than did farmer respondents.

STUDY OF INSECT PRESENCE IN ELEVATORS

In 1987, a study was conducted at 23 elevators located throughout the study area to determine the types and numbers of stored-grain insects in the elevators and the seasonal population patterns. The stored wheat itself was not sampled, because elevator storage tanks are relatively well-sealed structures, and the static mass of grain within the tank is too large to sample accurately without special equipment. However, elevators provide a variety of harborages for insects. Grain and grain dust residues accumulate in unloading pits and elevator legs, in the underground tunnels and overhead structures that house the transport belts, in ground-level access areas, and in and around feed mill equipment. These areas were sampled to provide a measure of the relative potential for infestation of the stored grain.

Methods

Food traps constructed of wire mesh and containing 177 g of bait mixture (7 percent kibbled carob and 31 percent each of rolled oats, cracked wheat, and cracked corn) were placed at various locations within each elevator. Ten food traps were placed per elevator beginning in June, 1987 and were replaced every 21-27 days thereafter through May, 1988. As each trap was replaced, the exposed trap was placed immediately in a sealed container and returned to the laboratory. The contents were passed over a number 10 sieve, and adult insects were identified and counted. Counts were adjusted to a 30-day basis. Pheromone-baited sticky traps were used to capture lesser grain borer (*Rhyzopertha dominica*) and Indian meal moth (*Plodia interpunctella*). These sticky traps were placed and collected at the same time as the food traps.

Traps were distributed as evenly as possible in the feed mill, if present; in overhead areas (bin tops and headhouses); at ground level (control rooms, offices, and storage areas); and in below-ground areas (tunnels, elevator boot pits). SAS software (21) was used to analyze data based on location in the state, location within the elevator, and presence or absence of feed mill.

Results

The seasonal pattern of insect presence was similar to that observed in farm-stored grain (Fig. 19). Populations were lowest from December to June, began to increase about March, and peaked about September. In this study, insects were trapped from areas exposed to temperature changes, whereas those detected on-farm were living in the insulated environment of grain masses. This may explain why populations appear to increase over a longer period in the fall and winter on farms than in elevators. Differences also occurred between species of insects relative to seasonal development patterns. Populations of rusty and flat grain beetles (*Cryptolestes* spp) peaked earlier than did those of sawtooth grain beetles (*Oryzaephilus* spp.) and weevils (*Sitophilus* spp.) (not shown).

Lesser grain borers were captured in large numbers from June through September but were absent from December through April. The separate, flight-trap studies also demonstrated peak flight activity of the lesser grain borer during this period of time. What is not clear is whether insects trapped in elevators originated there or were new arrivals from an outside source of infestation. Weevils of the genus *Sitophilus* present the greatest danger to wheat stored in elevators, according to Reed et al. (20). In the elevator trapping study, they were detected beginning in early April, and the greatest number was captured in late September.

Geographic location was significantly ($p < 0.05$) associated with the presence of a feed mill. Eight of 10 elevators in the southern half of the study area had an associated feed mill, whereas only 5 of 13 elevators located in the north included a feed mill. Thus, it was impossible to determine whether the difference in developmental patterns between northern and southern parts of the study area (Fig. 20) was due to location or presence of a feed mill. More insects were captured from elevators located in the north during the spring, whereas in the fall and winter, more insects were captured from southern elevators.

The presence of a feed mill significantly ($p < 0.01$) affected the number and type of insects captured in food traps. Nearly twice as many insects per trap, on the average, were captured in elevators that did not have an associated feed mill (Table 19). We were not able to determine whether this was due to smaller numbers of insects at locations containing a feed mill, or whether the trapping method, which relied on freshly cracked grain to lure insects, was less effective near a mill, where large amounts of grain were being processed. Flat grain beetles constituted 80 percent of the insects captured at locations without a feed mill, but only 30 percent at sites with a feed mill.

Regardless of geographic location or presence of a feed mill, more insects were captured per trap from underground locations than from other locations within the elevator complex ($p < 0.01$). The flat grain beetle was the only species captured in large numbers in upper-level areas through most of the year. However, the lesser grain borer was captured in nearly equal numbers in all areas of the elevator complex during its peak flight period (August and September). Therefore, warm wheat that is moved through open air (e.g., on open belts) in those months probably is at risk of infestation by the lesser grain borer.

STUDY OF INFESTATION AND DETERIORATION IN STORED WHEAT

During the survey interviews, elevator managers often offered information that reflected a common belief in the grain trade relative to infestation and deterioration in marketed wheat — that most of the infestation problems encountered in wheat market channels originate in farm storage. The only research report supporting this belief appears to be one by Hawk (9) that more samples of wheat from farm storage than from elevator storage were graded “weevily” at certain terminal elevators. In order to compare insect-related conditions in farm and elevator storage and to evaluate the effect of infestation and grain deterioration during storage in elevators and on farms on the overall quality of wheat and its products, a subset of the 1986-87 farm-stored lots was compared with wheat stored in nearby elevators.

Methods

One farm and one elevator from each of the randomly selected counties was chosen at random. Farm samples were taken as described in Reed et al. (20). Initial elevator samples were taken either by coring the selected tank or probing flat stores shortly after harvest or by combining samples taken as wheat was received and loaded into the selected tank. Poststorage samples were taken from the transport belt during load-out or during coring of the bin after several months of storage.

Samples were sieved to remove insects, which were identified and counted. Duplicate samples were sent to the Kansas Grain Inspection Agency for official grade and analysis of various factors. In addition, random portions of the samples were analyzed for insect-damaged kernels as defined by the Food and Drug Administration (FDA) or for degermed kernels or were x-rayed to determine internal infestation. About 550 g was cleaned through a Carter Dockage Tester, and 500 g was tempered to 16 percent moisture content and milled on a Brabender Quadromat Senior break head. The resulting flour was sieved through a 9XX cloth, where the break flour was separated and collected. The material remaining on the cloth was reduced on a Ross smooth roller mill and then sieved to collect the reduction flour. The break and reduction flours were prepared for insect fragment analysis according to the AACC standard procedure 28-41A (1). Insect fragments were counted and reported on the basis of 50 g of flour, weighted to reflect the proportions of break and reduction flours.

Results

Insect populations were larger in farm than in elevator stores through the fall and winter (Fig. 21). By December, the average insect density was more than four times greater in farm-stored wheat than in wheat stored in elevators. However, most of the insects found in samples from farm-stored wheat were less damaging types, whereas most of the insects recovered from elevator-stored grain were weevils or lesser grain borers, which cause grain damage and contamination.

By the end of the experiment, more than three-fourths of the farm lots were infested, whereas less than a quarter of the out-bound, elevator-stored, grain samples contained insects (Table 20). The total amount of infested wheat was greater at elevators than on farms, because the typical elevator tank contained an average of 11 times the quantity of grain in each farm bin. Nevertheless, the potential effect of infestation in farm storage was great, because much of the farm-stored wheat was delivered to commercial storage in early winter, when insect density is typically greatest. This underscores the importance of elevator managers' policies that provide incentives to producers to reduce infestation before delivery from farm storage.

None of the samples from farm-stored lots contained IDK after 4 months of storage, although a few IDK were found after 6 months. Poststorage samples from elevators contained 5.8 more IDK per 1000 g, on the average, than did the initial samples, and 22.6 percent of the samples had more IDK after storage than initially. More than a third of the farm samples contained internally infested kernels, and the number of degermed kernels increased by 13.1 per 1000 g. Overall, the

farm samples showed a greater level of infestation than did elevator samples, but the amount of permanent damage and contamination was about the same during elevator and farm storage.

When the insect fragment content of flours milled from the wheat was compared, the relatively small impact of deterioration in farm storage was obvious. Between harvest time and 6 months thereafter, almost all samples produced less than 20 fragments per 50 g of flour (Fig. 22). By this time, only two of the 26 farm-stored lots remained in storage, and samples taken between 6 and 10 months after harvest were from elevators. Samples from elevators tended to produce greater amounts of contamination in the flour. Only one sample produced flour containing more than the FDA limit of 75 fragments per 50 g, but 13 samples exceeded 25 fragments per 50 g, and five of those contained more than 50 fragments per 50 g. These results indicated that, although farm-stored wheat is indeed likely to be infested during the fall, much of the insect-produced contamination of wheat and wheat products occurs in grain that was not stored on-farm.

V. IMPROVING PEST CONTROL IN FARM-STORED WHEAT

We conducted a series of trials designed to test possible solutions to the problems encountered in the initial field trials (see Part II). The objective was to refine existing technology or to develop new technology that would facilitate quality maintenance in farm-stored wheat by making it more convenient, more effective, safer, and less expensive.

DELAYED APPLICATION OF PROTECTANTS

Insect trapping and grain sampling data from the 1986-87 study showed that insects were concentrated at the surface early in the storage season and tended to be found at the center of the grain mass as fall progressed (18). Because surface and center grain is removed first when a center-discharge bin is unloaded, we theorized that, if a portion of the bin were unloaded and treated with protectant as the grain was replaced, the protectant could be applied to the part of the grain mass where it would be most effective (Fig. 23). This would reduce the cost of treatment, because less than a third of the grain would receive the chemical. Other potential advantages were that the application could be delayed until after the harvest-time rush and that the delay would result in fewer days of exposure to intense summer heat, which destroys the insecticidal properties of malathion and CM.

Therefore, studies were conducted in 1989 and 1990 to determine whether the delayed application was useful (16). The 1989 study showed that, in the absence of grain cooling, the delayed application of CM helped control insects in some lots through September, but did not significantly reduce the need to fumigate in order to prevent grain damage. In a larger study (1990), aeration was used to cool the grain. Half the lots treated with a delayed application of CM became infested with lesser grain borers, and mean insect densities in traps were

greater in lots receiving the delayed malathion treatment than in the untreated lots.

Thus, the delayed application technique did not appear to provide advantages over no protectant treatment in aerated grain. The technique also presented practical problems. Most farms were not equipped to recirculate grain easily. Delayed application required that augers and grain trucks be brought out of storage and cleaned before grain could be moved, then returned to storage after the protectant was applied. The procedure required an average of 2-4 hours and did not appear to be worth the extra time and effort involved.

PROTECTANT-AERATION COMBINATION

The 1990 study showed that the combination of aeration and application of CM (Reldan®) during bin-loading provided a large measure of security against insect infestation. The CM was applied at the recommended rate of 6 ppm at harvest, and aeration was used to reduce grain temperatures from an average of 100°F (38°C) to 80°F (27°C) in September and then to 50°F (10°C) by mid-December. None of the lots receiving this treatment ever became sufficiently infested that insects could be detected in the grain samples. The combination of CM and aeration was the highest-cost option, but it may be attractive to producers who are willing to pay for a maximum degree of security against damage or discounts.

SURFACE COVERS FOR FUMIGATION

Fumigators have long recognized that controlling the rate at which fumigant leaks from the fumigated structure is critical to success and that farm bins are extremely leaky structures. More recently, Winks (24) showed that the success of a phosphine fumigation depends more on the ability to maintain

a toxic concentration for several days than on the maximum concentration attained. Certain insect stages, especially young eggs and pupae, are very resistant to phosphine gas and are not killed easily until they mature. The maturation process takes several days. Therefore, it was not surprising that we observed many fumigation failures during the field studies.

Sealing all ground-level openings with tape and plastic sheeting and covering the grain surface with plastic tarpaulins are standard recommendations for farm-bin fumigations. However, we observed that neither farmers nor commercial pest-control operators often followed these recommendations. Typically, the extent of compliance with recommendations consists of sealing the fan openings. Often, sealing was done with a plastic thinner than that recommended for fumigation. In order to determine the characteristics of fumigated lots of wheat when the grain surface was not covered, a series of studies was conducted in 1988.

Phosphine fumigant at the rate of 100 tablets per 1,000 ft³ was probed into the top 5 ft (1.5 m) of grain in two 18-ft (5.4 m) diameter bins containing 1,000 bushels (27 t) of wheat (21). Ground-level openings had been sealed in both bins, but in one, the grain surface was covered with 3-mil plastic sheets after the fumigant was placed, whereas in the other, the surface was not covered. Gas sampling tubes and cages containing live stored-product insects were placed in strategic locations throughout the grain masses. In the covered lot, an average of nearly 300 ppm phosphine was present after 17 hrs, and the majority of the sampling points contained more than 200 ppm (Fig. 24). Less than 100 ppm phosphine, on the average, were present in the uncovered bin, and the fumigant was distributed poorly. After slightly more than a day, the average fumigant concentration was four times greater in the covered than the uncovered lot, and all sampling points in the covered grain contained more than the target concentration of 200 ppm, compared with only a third of the points in the uncovered grain.

Although all test insects (adults) were killed in both bins, the advantage of covering the grain surface was obvious. The test showed why fumigations of farm bins may fail when the surface is not covered. However, even in the covered lot, the gas concentration had degraded to less than 100 ppm by the fourth day, and some locations within the grain mass frequently contained less than 200 ppm. A concentration of >200 ppm phosphine for at least 5 days is considered ideal by many researchers, who fear that consecutive fumigations wherein only certain insects are killed will contribute to the development of resistant insect populations.

Many of the gas sampling points having the lowest fumigant concentration were located near the bottom of the grain mass. When the experiment was repeated, this pattern was again obvious. Fumigant tended to be found near the surface, and little made its way to the lower sampling points, located 2 ft below the lowest tablet (Fig. 25). During both experiments, the grain temperature was in the 60 to 70°F range (15.5-21.0°C), and air temperatures ranged from 60 to 100°F (15.5-38.0°C). Therefore, the chimney or stack effect that causes upward air currents when grain is warmer than surrounding air should not have been a factor.

In one of the 1990-study bins that was fumigated by probing, test insects 3 ft (0.9 m) below the the deepest fumigant tablet survived the fumigation, whereas those near the surface were killed, indicating that fumigant vapors did not migrate downward even though the surface had been sealed properly. These experiments demonstrated that covering the surface improved the distribution pattern of the fumigant gas, but did not always result in complete kill.

GROUND-LEVEL FUMIGANT APPLICATION

In the 1988 trials, we encouraged a toxic gas concentration at the lower portions of the grain mass by applying the fumigant formulation from beneath the grain. The effect of surface covers on the ground-level application also was investigated.

Ground-level fumigation was accomplished by first placing the phosphine fumigant tablets in long trays, then inserting the trays into the aeration ducts or plenum chamber. This type of application has safety advantages, because the fumigator does not enter the fumigated structure and, therefore, is exposed to less fumigant vapor. The trained fumigator is not required to have a gas mask available, if he does not enter the fumigated structure. Neither is he required to have a partner, if the fumigant is applied from outside the structure. Thus, ground-level fumigation would appear to have advantages for farmers who choose to fumigate on-farm without assistance.

The fumigation trays were made from sections of 6-inch flexible drainage tile. This perforated tubing, widely used for soil drainage, is inexpensive and readily available. Ends were closed with wooden disks, and the tile was cut open lengthwise to allow the fumigant tablets to be scattered along its length. Where possible, rigid trays were constructed by nailing the tile to thin wooden boards. However, in many cases, the trays must remain flexible in order to be snaked between the supports of the false floor of the bin. In either case, trays served to retain the fumigant residue and to ensure that the unreacted fumigant did not contact liquid water. Unprotected fumigant formulation may flash and cause a fire if it contacts water or wet material in the ducts or plenum chambers.

In bins that did not have aeration equipment, a loop of perforated flexible drain tile was placed on the floor prior to filling the bin. The ends of the loop were brought to the grain door and secured, a small-diameter rope with metal clips attached was placed inside the tubing, and the ends were tied together to form a closed ring. In order to locate the fumigant beneath the grain, strings of fumigant formulation in sachets were attached to the clips and pulled through the tube.

In the 1988 study, average gas concentrations were higher when the grain surface was covered than when no plastic tarpaulin was used in lots fumigated from ground level (Fig. 26), but the difference was not as great as when the fumigant was probed into the grain (Fig. 24). Except for a short period during the third day, the average gas concentrations in both lots remained above 200 ppm for 74 hours, compared with only 60 hours for the covered and 0 hours for the uncovered lots when the fumigant was probed into the grain.

Because the majority of insects are found at or near the grain surface in most infested farm-stored wheat, it was important to determine how quickly a toxic gas concentration would develop at the grain surface when the fumigant was applied from beneath the grain. When gas concentrations were compared at surface locations in lots with uncovered surfaces, they reached the 200 ppm level later during the ground-level fumigation but remained above this level longer than when the fumigant was probed into the top of the grain (Fig. 27). The peak concentration near the surface was similar regardless of the application technique. These results confirmed that phosphine gas quickly moved upward in farm-stored wheat and distributed well when applied from beneath the grain.

The results of the covered, ground-level fumigation appeared to indicate that this is an effective fumigation technique in farm-stored wheat, because it resulted in toxic gas concentration for a longer period of time than other application techniques. However, the bins used in the 1988 study were much smaller than those commonly found on Kansas farms. Therefore, studies were conducted to determine the efficacy of the technique in larger bins (3,000 to 6,000 bu, 81-162 t). In 1990, seven lots were fumigated, four by probing, two by ground-level application, and one by a combination of probing and ground-level application. In all lots, the grain surface was covered during the fumigation and cages of test insects were placed at several locations within the grain mass. One of the probed fumigations failed, but the ground-level and combination fumigations killed all test insects.

The ground-level application technique was further tested in 10,000 and 25,000 bu (270 and 680 t) metal bins. The 10,000-bu lot (grain sorghum) was peaked and could not be covered, whereas the larger lot (corn) was leveled and covered with plastic tarpaulins. Phosphine concentrations were lower than in the smaller trials, and the pattern in the uncovered grain sorghum varied consistently between morning and evening. The grain temperatures in these lots ranged between 60°F and 70°F (16-21°C), whereas the ambient temperatures were much cooler than the grain, especially at night, so chimney effects may have influenced these results. Although gas concentrations in excess of 200 ppm were not maintained, reasonably high levels were present after 5 and 6 days, in contrast to the smaller lots, from which the gas escaped in less than 100 hours.

In the large bins, the fumigant formulation was placed about 25 ft (7.5 m) below the grain surface. Nevertheless, concentrations greater than 100 ppm were present at the top sampling site and in the peak of the grain sorghum within 24 hours (Figs. 28 and 29). In the covered lot, the concentration was nearly 200 ppm after 5 days. In the peak of the uncovered lot, more than 400 ppm were present 161 hrs after the fumigation, but the concentration was extremely variable, and the top sampling point near the north side of the bin wall consistently registered low levels of gas. The extreme diurnal variation at the peak and top center sampling points (Fig. 30) may have been the result of wind patterns or chimney effects or some effect exacerbated by the peaked grain, although similar patterns also were seen at other locations in both large

grain masses. Despite the unexplained diurnal variation, two important questions relative to ground-level application in large bins were answered. First, covering the grain surface decreased the variability over time and between locations within large grain masses fumigated from ground level. Second, fumigant gas accumulated to toxic concentrations near the covered grain surface within 24 hours, even when applied 25 ft below the surface.

FUMIGATION-AERATION COMBINATION

An experiment was conducted in 1992 to determine the relationship between grain temperature and fumigant distribution and retention in leaky bins. Six small (50-bu capacity) corrugated metal bins were placed in a temperature-controlled room, filled with wheat at 11.2 percent moisture content, and fumigated. The air movement in the room and the amount of open area through which fumigant could escape each bin were manipulated until the pattern of gas concentration and degradation approximated that observed in the trials with 1,000-bu bins. The grain and room temperatures were brought to either 68°F (20°C), 77°F (25°C), or 86°F (30°C), and the grain was fumigated at the rate of 73 phosphine tablets per 1000 ft³. The grain was then tempered to 13.8 percent moisture content, and the experiment was repeated.

Both moisture content and temperature were significantly related to the fumigant concentration profile in the grain masses, but temperature had the greater effect (Fig. 31). The two lower temperatures provided approximately equal concentration by time (CT) profiles, whereas fumigant concentration peaked and degraded rapidly at 86°F.

On the basis of the CT relationship alone, fumigations done at grain temperatures in the 68 to 77°F range seemed to have the best chance of succeeding. However, other temperature-dependent factors may affect the success of fumigation. The uniformity of fumigant distribution is important, because the more uniform the gas concentration, the less chance that insects may encounter locations where the gas concentration is not high enough for a long enough period to complete the kill. In our study, more variability occurred at higher than lower temperatures (Fig. 32). Moreover, insects develop slower at lower temperatures, which extends the amount of time spent in the resistant life stages (early egg and pupae). Therefore, determination of the optimum conditions for fumigation must account for the gas concentration profile over time, the rate of insect development, and the uniformity of concentration within the grain mass.

At 77°F (25°C), an optimum development time/CT profile was achieved, and gas distribution was only marginally more variable than at 68°F. Therefore, this temperature provided the best relative advantage in the dry wheat.

AUTOMATED AERATION

Aeration controllers were fabricated and tested from 1990 to 1992 to determine whether automatic devices would provide a more timely and convenient method of aeration

management. These devices sense air temperature, activate aeration fans when the temperature is below the set limit, deactivate the fans when the air temperature is above the limit, and record fan hours. They were placed at 10 farm sites in east-central Kansas, located from 10 miles south of the Nebraska border to 30 miles north of the Oklahoma border. The grain lots ranged in size from 1,000 bu (27 t) to 9,000 bu (243 t), and airflow rates varied from 0.1 to 0.3 cfm/bu. Grain temperatures at the warmest places within the grain masses (middle and upper center) were compared for the automatically controlled lots (1990-91) versus the manually controlled (1990 study) and naturally cooled lots (1987 study).

Most of the automatically controlled aerated bins were visited at 2- or 3-week intervals, less often than would be possible if the grain producer himself were managing the aeration. Nevertheless, reduction in grain temperatures was possible by mid-August, and by September 1, the average temperature at the warmest place in the grain masses had been reduced to about 73°F (23°C) (Fig. 33). In wheat at 11.0 percent moisture content, this amount of temperature reduction slows the growth rate of lesser grain borer by more than 4 times (7). By October 1, average temperatures in all parts of the grain masses in automatically controlled aeration bins were reduced to below the minimum for growth of lesser grain borer in wheat with 11.0 percent moisture content. In contrast, the warmest temperatures in unaerated lots were in the range of 85 to 90°F (29 to 32°C), which is near the optimum for stored-product insect growth, through November and were still adequate for insect growth through mid-December.

During the 1992 study, cages containing about 2,500 g of wheat were placed near the surface of the grain in identical

bins. In one bin, air at the rate of 0.23 cfm/bu was pushed up through the grain, whereas air was pulled downward at the same speed in the other lot. The fans were controlled by a single apparatus. Cages also were placed in controlled-temperature chambers in order to simulate conditions in the unaerated lots (1987 study) and the manually controlled aeration lots (1990 study). Ten adult lesser grain borers and 10 flat grain beetles were placed in each cage on July 10; one cage was opened, and insects and IDK were counted biweekly beginning on August 18 to demonstrate the effects of grain cooling on the population increase in grain with a large initial infestation. Both the insect populations and the numbers of IDK increased greatly under unaerated conditions and nearly as rapidly under conditions of manually controlled aeration (Figs. 34 and 35). In automatically controlled, aerated lots, insect numbers and IDK counts increased initially, but the rate of increase was suppressed greatly.

The level of initial infestation was considerably greater than investigators have observed in newly harvested wheat and represented the extreme case in which manual aeration does not cool grain quickly enough to limit damage substantially. However, grain damage was reduced greatly by the cool temperatures achieved with the assistance of automatic controllers under Kansas field conditions. During the on-farm studies, none of the properly managed lots with automatic aeration controls developed damaging insect populations, and in those lots wherein a few insects were detected, the populations were controlled by November 1. These results indicate that when automatically controlled aeration is properly managed, quality of farm-stored wheat can be maintained in Kansas without the assistance of pest control chemicals.

SUMMARY

STORAGE EQUIPMENT

The majority of farm-stored wheat was held in cylindrical bins of corrugated metal, and 76.5 percent of the total capacity was equipped for aeration. Less wheat was stored on-farm in 1991 than in 1986, and nearly one fourth of the persons surveyed in 1986 had ceased storing wheat by 1991. The mean storage capacity per farm ranged from about 11,000 bushels in central Kansas to more than 40,000 bushels in western Kansas. Most farmers reported 20,000 bushels or less of on-farm storage capacity for wheat, but the 12.6 percent of farms having more than 50,000 bushels of capacity accounted for nearly half of the state's total.

STORAGE PRACTICES

In 1991, most (>80 percent) producers reported that they followed recommended pest control practices, such as cleaning and treating empty bins and removing spilled grain. Nearly three-quarters reported that they applied a grain protectant to farm-stored wheat, and half said that they had fumigated their wheat in the previous year. Thirty-five percent of these fumigations were performed by commercial pest-control

operators. Respondents who said that they had been penalized for delivering infested grain to the elevator were more likely to have fumigated than those who had not received a price discount. Two-thirds of the surveyed farmers reported using aeration to cool farm-stored wheat, and 64.8 percent of these said that they began the cooling process shortly after harvest. Specific technical questions about aeration received fewer responses and fewer credible answers than questions related to other types of pest control practices, indicating the need for more information and training relative to proper aeration management.

STORAGE CONDITIONS

Changes in grain temperature, moisture content, and insect populations were studied in a series of surveys and experiments. In unaerated grain, severe temperature gradients appeared by mid-winter. Surface grain and grain nearest bin walls became coolest, whereas grain near the center of the mass lost little heat. Water migrated toward the grain surface, causing the surface grain to gain more than 3 percentage points of moisture between August and February. The moisture content of the grain a few feet below the surface increased from

12.4 percent to nearly 14 percent during this period. This created a layer near the upper center of the grain mass of wheat containing high levels of both heat and water, which often resulted in grain deterioration. The magnitudes of the temperature gradient and moisture migration were greater in larger grain masses.

Insects were found in 76.9 percent of surveyed bins of farm-stored wheat shortly after harvest and in 97.1 percent by September, regardless of the type of treatment applied to the grain or empty bin. Most insects present were flat or rusty grain beetles (*Cryptolestes* spp), flour beetles (*Tribolium* spp.), sawtooth grain beetles (*Oryzaephilus* spp.), or other types that cause little grain damage, but lesser grain borers (*Rhyzopertha dominica*), which damage grain kernels, were found in increasing numbers through fall and early winter. In 1986-1987, the density of insect infestation was less than 1 per sample in July, approximately 4 per sample (1000 g) in September and November, 1.5 in January, and less than 1 in March.

EFFECTIVENESS OF PEST CONTROL

Empty-bin treatment appeared to help reduce insect numbers in stored wheat through late summer and early fall. Treating wheat with malathion during binning gave variable results, possibly because of thermal breakdown, and did not reduce the likelihood of having to fumigate in order to control insects. Chlorpyrifos-methyl insecticide (Reldan[®]) applied to the grain at binning was more expensive than other pest control measures but effectively controlled insects through December. Fumigation failures, as evidenced by insect presence within a few weeks or months after treatment, were observed frequently in metal farm bins. Fumigant gas escaped rapidly, if the grain surface was not covered with tarpaulins. Failures also were observed frequently in protectant-treated wheat. When samples of wheat that producers said had been treated with grain protectant after harvest were bioassayed in September, only a third demonstrated any insecticidal properties, and most of the grain lots became infested by November. Insects also were found frequently in wheat that had been aerated improperly.

MARKETING FARM-STORED WHEAT

The relationship between buyer, seller, grain quality, and market price was investigated in a series of surveys and experiments. Many (56.4 percent) farmers responding to surveys said that they had received price discounts because of some grain quality factor, although penalties were applied more often for test weight and dockage than for storage-related factors (insects, damage, and odors). Many (56.7 percent) producers also reported that grain sampling and discounting policies for insect-related factors became stricter after the 1988 changes in the U.S. wheat standards.

Managers of country elevators differed in their perceptions of the relationships between themselves and their client producers and between wheat quality factors and price

discounts, depending on the type of business, size of the elevator, location within the state, and business environment. The surveyed elevators received an average of 68,000 bu each of farm-stored wheat from a mean of 24 farms per year, but the amount of grain and number of farmers were larger in the northern part of the state and at larger elevators. Two-thirds of the managers said that their policies relative to insect-related quality factors were stricter in 1991 than in 1986, and nearly half reported that this change caused them to lose business. Two-thirds reported that their policies relative to price discounts for grain quality factors were fixed, but the remainder said that policies varied depending on the customer or circumstances. Most elevator managers reported that the policies of their wheat buyers relative to infestation became stricter after the 1988 changes in wheat standards.

Two studies of discount-related behavior indicated that, the perceptions of farmers and elevator managers notwithstanding, the relationship between storage-related grain quality factors and price discounts had changed little between 1986 and 1991. Two-thirds of the infested lots had received discounts, and among all lots containing more than five insects per 1000-g sample, 75.8 percent and 70.0 percent were discounted in 1986 and 1991, respectively. Lots with low test weight were more likely to be penalized than highly infested lots in both years, indicating that the market placed more importance on test weight than on insect-related factors. The signal from the market to the producer did not vary from 1986 to 1991: low test weight or high dockage content always results in a price reduction, but the presence of insects or insect-damaged kernels may not. In 1991, the mean discounts for insects were 3.1¢/bu, if five or fewer insects were found, and 3.6¢/bu, if more than five insects were present. When the probability of receiving the discount was considered, the mean probable discounts were 1.9¢/bu and 2.5¢/bu, respectively, if 0.1 to five and more than five insects per sample were present.

STORAGE PRACTICES AND CONDITIONS AT ELEVATORS

In 1991, 31 percent of elevator managers reported applying grain protectants to stored wheat. This was a slight increase from 1986 (25 percent). Fumigation usually was performed as grain was moved from one bin to another (78 percent). Whether the fumigation was prescheduled or applied as needed depended on the type of storage structure and elevator size and management factors. At most (61 percent) of the surveyed sites, some fumigations were performed by elevator employees. Commercial pest control operators were employed to perform all fumigation at 18 percent of the surveyed sites and for flat stores or other difficult fumigations at 14 percent of the sites.

The pattern of insect population growth in and around elevators, as determined by trapping, was similar to that observed on farms, being lowest from December to June and increasing through summer and fall. Insects were collected most often from tunnels, boot pits, and other underground structures. Twenty-three percent of sampled wheat lots were

infested after several months of storage. The majority of the insects captured in the grain were lesser grain borers or weevils (*Sitophilus* spp.), which cause grain damage.

INNOVATIONS

Because the recommended insect-control practices often failed under farm conditions, methods of improving their performance were tested. The economic incentives to control insects were small and inconsistent, so only low-cost innovations were examined. Delayed application of protectant to part of the grain mass proved unsatisfactory. The combination of

Reldan® treatment at harvest and timely cooling with aeration provided excellent control of insects in farm-stored wheat but was the most costly option (about 2.2¢/bu). Timely aeration was successfully achieved with the assistance of automatic aeration controllers, which activate aeration fans when the ambient air is cool and record the fan-hours. With the assistance of these inexpensive management tools, grain temperatures were reduced quickly enough to limit and eventually stop insect growth without the use of chemicals. Fumigation of grain in metal bins was improved by covering the surface with plastic tarpaulins and by introducing fumigant from beneath the grain mass.

RECOMMENDATIONS FOR ON-FARM STORAGE OF WHEAT

Sanitation Bin clean-up should be done when the bin is emptied, not shortly before harvest. All grain, dust, and trash should be removed with a heavy-duty vacuum cleaner. Bin spray can be applied 2 to 4 weeks before harvest.

Aeration Wheat should be cooled with aeration as soon as cool air is available. Air temperatures should be 10-15°F or more cooler than the grain. The use of aeration controllers is recommended. Dry wheat should be cooled to below 50°F as soon as possible, then fans should be covered.

Monitoring Stored grain should be monitored at least monthly by sampling and measuring the temperature. Grain samples should be sieved in order to detect insects more easily. The use of temperature cables is recommended.

SAM System **S**anitation, **A**eration, and **M**onitoring provide an effective and inexpensive system of pest control for farm-stored wheat in Kansas and should be adopted.

Protectant Persons who want the maximum protection against insects can treat the grain with Reldan® according to label instructions. The grain must be cooled within a few weeks after treatment, because the protection is temporary. Malathion treatment of wheat is not recommended, because it is often ineffective under conditions of farm storage in Kansas.

Fumigation If fumigation cannot be avoided, steps should be taken to increase the probability of complete kill. Proper sealing of the bin is critical. Ground-level openings must be sealed with tape and plastic at least 3 mils thick. The grain surface also must be covered. If possible, the grain temperature should be brought to between 70 and 80°F. In bins containing 10,000 bushels or less, fumigant may be applied from beneath the grain mass. If this technique is used, the fumigant must be applied inside trays to ensure that it cannot contact water or wet material.

REFERENCES

1. American Association of Cereal Chemists. 1983. Approved Methods of the AACC. 8th Ed. Method 28-41A, approved April 13, 1961. The Association, St. Paul, MN.
2. Barak, A. V. and P. K. Harein. 1981. Unpredictable penalties at time of sale applied to insect-infested, farm-stored grain in Minnesota. *Bull. Entomol. Soc. Amer.* 27:166-169.
3. Barak, A. V. and P. K. Harein. 1981. Losses associated with insect infestation of farm-stored shelled corn and wheat in Minnesota. Misc. Pub. 12-1981, Agricultural Experiment Station, University of Minnesota St. Paul, MN.
4. Ben Hamza, H. 1990. Field infestation of wheat by stored-grain insects. M.S. Thesis. Department of Grain Science and Industry, Kansas State University, Manhattan, KS.
5. Cotton, R. T. and T. F. Winburn. 1941. Field infestation of wheat by insects attacking it in farm storage. *J. Kansas Entomol. Soc.* 14:12-15.
6. Cuperus, G. W., C. K. Prickett, P. D. Bloome, and J. T. Pitts. 1986. Insect populations in aerated and unaerated stored wheat in Oklahoma. *J. Kansas Entomol. Soc.* 59: 620-627.
7. Desmarchelier, J. M. 1988. The relationship between wet-bulb temperature and the intrinsic rate of increase of eight species of stored-product Coleoptera. *J. Stored Prod. Res.* 24:107-113.
8. Harner, J. P. and R. A. Higgins. 1989. Commercial storage structures in Kansas and management practices related to wheat, grain sorghum, corn, and soybeans. Internal Report, Departments of Extension Agricultural Engineering and Extension Entomology, Kansas State University, Manhattan, KS.
9. Hawk, A. L. 1979. Control of insects in transport, terminal storage, and export facilities. Proceedings of the Symposium on Prevention and Control of Insects in Stored-Food Products. P. 7-14, United States Grain Marketing Research Laboratory, SEA, U.S. Department of Agriculture, Manhattan, KS.
10. Ingemansen, J. A., D. L. Reeves, and R. J. Walstrom. 1986. Factors influencing stored-oat insect populations in South Dakota. *J. Econ. Entomol.* 79:518-522.
11. Kansas Grain and Feed Association. 1990. Kansas Official Directory. Topeka, KS.
12. Reed, C. 1986. On-farm wheat storage in Kansas: A description, assessment of losses and a comparison of quality maintenance costs under various pest control strategies. Ph.D. Dissertation. Department of Grain Science and Industry, Kansas State University, Manhattan, KS.
13. Reed, C., K. Anderson, J. Brockschmidt, V. Wright, and J. Pedersen. 1990. Cost and effectiveness of chemical insect control measures in farm-stored Kansas wheat. *J. Kansas Entomol. Soc.* 63:351-360.
14. Reed, C. and J. Pedersen. 1987. Farm-stored wheat in Kansas: Facilities, conditions, pest control, and cost comparisons. Bull. 652, Agricultural Experiment Station, Kansas State University, Manhattan, KS.
15. Reed, C. and J. R. Pedersen. 1988. Wheat kernel damage produced before harvest. *Assoc. Oper. Millers Bull.* Dec.:5353-5355.
16. Reed, C., J. R. Pedersen, and G. W. Cuperus. 1993. Efficacy and cost effectiveness of grain protectants applied to farm-stored wheat at harvest and later. *J. Econ. Entomol.* 86:1590-1598.
17. Reed, C., B. Schurle, and R. Fleming. 1988. Stored wheat and the Kansas country elevator. Rep. Prog. 535, Agricultural Experiment Station, Kansas State University, Manhattan, KS.
18. Reed, C., V. F. Wright, T. W. Mize, J. R. Pedersen, and J. Brockschmidt Evans. 1991. Pitfall traps and grain samples as indicators of insects in farm-stored wheat. *J. Econ. Entomol.* 84:1381-1387.
19. Reed, C., V. F. Wright, J. R. Pedersen, and K. Anderson. 1989. Effects of insect infestation of farm-stored wheat on its sale price at country and terminal elevators. *J. Econ. Entomol.* 82:1254-1261.
20. Reed, C., V. F. Wright, J. R. Pedersen, and L. Wongo. 1989. Wheat quality deterioration caused by insects and molds during the first months of storage on farms and in country elevators in Kansas. *J. Kansas Entomol. Soc.* 62:563-574.
21. SAS Institute. 1985. SAS User's Guide: Basics. SAS Institute, Cary, NC.
22. Skidmore, J. 1989. A comparison of phosphine fumigation methods for farm-stored wheat. M.S. Thesis. Department of Grain Science and Industry, Kansas State University, Manhattan, KS.
23. Walkden, H. H. 1951. Farm storage of cereal grains. *Milling Prod.* 16:1,7,23-25.
24. Winks, R. G. 1984. The toxicity of phosphine to adults of *Tribolium castaneum* (Herbst): Time as a dosage factor. *J. Stored Prod. Res.* 20:45-56.
25. Worman, F., C. Reed, B. Schurle, S. Duncan, and J. Pedersen. 1993. Kansas country elevator wheat storage practices, 1991. Staff Paper 93-9, Department of Agricultural Economics. Kansas State University, Manhattan, KS.
26. Zettler, J. L. and G. W. Cuperus. 1990. Pesticide resistance in *Tribolium castaneum* (Coleoptera: Tenebrionidae) and *Rhyzopertha dominica* (Coleoptera: Bostrichidae) in wheat. *J. Econ. Entomol.* 83:1677-1681.

Table 1. Pest control as practiced by Kansas wheat producers in 1991.

Practice	Percent Respondents
Empty and sweep bin before filling	97.5
Spray empty bin with insecticide	84.3
Use a grain spreader when filling	17.4
Clean the grain after harvest	1.7
Apply a grain protectant as the bin is filled	71.1
Level the grain after filling	53.7
Apply grain protectant to top grain after filling	24.0
Clean up spills around the bin after filling	84.3
Fumigate the grain as a precautionary measure	17.4
Place a pesticide strip in overhead areas	28.9
Aerate to cool the grain	63.6

Table 2. Mean number of various types of insects in grain samples (1000 g) from Kansas farm-stored wheat, 1986-1987.

Insect	Mean Number of Insects				
	July	Sept	Nov	Jan	Mar
Lesser grain borer	trace	0.3±0.08	0.5±0.09	0.3±0.12	trace
Flat grain beetle	trace	2.0±0.49	0.6±0.12	0.2±0.09	trace
Flour beetle	trace	0.9±0.18	2.3±0.60	0.9±0.3	0.0
Sawtooth beetle	trace	0.5±0.10	0.0	0.1±0.04	trace
Other	trace	0.4±0.24	0.6±0.34	trace	trace

Table 3. Mean indices of cost of various treatment strategies (¢ per ton) for farm-stored wheat, 1989-1990.

Sample Date	1989	1989	1990	1990	1990
	CM	Untreated	Malathion	CM	Untreated
Jul	64.1	0	5.1	64.1	0
Aug 1	64.1	42.0	15.6±9.3	64.1	10.5±6.6
Aug 29	64.1	74.1±12.6	36.6±10.5	64.1	16.8±7.4
Sept	85.1±12.8	123.4±15.4	56.8±16.5	64.1	28.3±11.7
Oct	105.3±19.5	52.6±23.9	74.9±16.6	64.1	40.9±11.7
Nov	113.7±29.5	55.1±48.2	47.8±13.4	74.6±13.4	30.1±9.5
Dec	103.2±23.6	48.6±56.2	68.8±12.5	64.1	30.1±8.8
Overall Mean	85.7±5.1	52.1±7.1	43.7±3.9	65.6±3.9	22.4±2.7

Table 4. Reasons for and type of discount received when Kansas farm-stored wheat was delivered to elevators, as recalled by producers, 1991.

Reason for Discount	Type of Discount	
	Price	Weight
Dockage or foreign material	41.2	58.8
Test weight	60.0	40.0
Live insects	90.1	9.9

Table 5. Size, location, and ownership of country elevators surveyed, 1986 and 1991.

Factor	1991 Number Sites	1986 Number Sites	Percentage Change '86 to '91	Percent Country Elevators Surveyed 1991
Overall	72	85	-15	28
Ownership:				
Cooperative	49	54	-9	37**
Independent	23	31	-35	18
Level:				
Headquarters	35	—	—	—
Branch	37	—	—	—
District:				
Northwest	6	8	-25	25
West	5	8	-38	25
Southwest	12	13	- 8	34
Northcentral	7	10	-30	23
Central	20	24	-17	27
Southcentral	22	22	0	30
Region:				
North	13	18	-28	24
Central	25	32	-22	27
South	34	35	- 3	31
Zone:				
West	23	29	-21	29
Central	49	56	-12	28
Size:				
Small	20	40	-50	18**
Medium	23	24	- 4	34
Large	29	21	+38	38

** P<0.01, χ^2 -test

Table 6. Ranking of enterprises in terms of dollar contribution to elevator profitability.

Factor	Order of Importance					Weighted Score ^a
	First (%)	Second (%)	Third (%)	Fourth (%)	Fifth (%)	
Grain merchandizing and storage (N=71)	86	11	3	0	0	343
Feed sales (N=54)	6	39	26	26	4	171
Fertilizer sales (N=55)	11	58	24	7	0	180
Animal health sales (N=34)	0	0	15	32	53	55
Petroleum product sales (N=39)	3	13	56	28	0	113
Other ^b (N=7)	14	14	43	14	14	21
Grain merchandising and storage:						
District:						
Northwest	50	17	33	0	0**	
West	100	0	0	0	0	
Southwest	100	0	0	0	0	
Northcentral	100	0	0	0	0	
Central	95	5	0	0	0	
Southcentral	71	29	0	0	0	
Region:						
North	77	8	15	0	0**	
Central	96	4	0	0	0	
South	82	18	0	0	0	
Feed sales:						
Ownership:						
Cooperative	2	31	21	33	2*	
Independent	17	33	42	0	8	

^a Weighting scheme: first place=5, second=4, third=3, fourth=2, fifth=1; weighted scores are summed with the highest having the greatest importance.

^b Seed operation (including cleaning and certified seed, 4); agrichemicals; consulting services; and milling.

* P<0.05, c²-test

** P<0.01, c²-test

Table 7. Mean trade area radius reported by elevator managers.

Factor	Mean (miles)	Standard Deviation (miles)
Overall (N=72)	17.3	16.1
Ownership:		
Cooperative	15.6	2.3
Independent	21.0	3.3
Level:		
Headquarters	20.6*	2.7
Branch	14.3	2.6
District:		
Northwest	20.5a*	6.5
West	32.4a	7.1
Southwest	15.0 b	4.6
North Central	14.4 b	6.0
Central	13.4 b	3.5
South Central	18.8a	3.4
Region:		
North	17.2	4.5
Central	17.2	3.3
South	17.5	2.8
Zone:		
West	20.3	3.3
Central	16.0	2.3
Size:		
Small	15.1	3.6
Medium	15.0	3.3
Large	20.7	3.0

Means with different letters are significantly different.

* P<0.05, t-test

Table 8. Competitors within trade areas reported by elevator managers.

Factor	Mean	S. D.
Grain merchandizing and storage competitors (N=70)	4.5	3.0
Feed sales competitors (N=54)	3.9	3.1
Fertilizer sales competitors (N=55)	4.4	2.8
Animal health products competitors (N=30)	3.6	2.1
Petroleum competitors (N=34)	5.1	3.7
Other competitors (N=7) ^a	4.3	2.8
Grain merchandizing and storage competitors:		
Level:		
Headquarters	5.3	0.5
Branch	3.8	0.5
District:		
Northwest	7.5a*	1.1
West	6.4a	1.2
Southwest	4.8 b	0.8
North Central	5.3 b	1.1
Central	3.5 c	0.6
South Central	3.8 b	0.6
Region:		
North	6.3a**	0.8
Central	4.1 b	0.6
South	4.2 b	0.5
Zone:		
West	5.8**	0.6
Central	3.9	0.4
Fertilizer sales competitors:		
Size:		
Small	3.3a*	0.8
Medium	3.9a	0.6
Large	5.3 b	0.6
Petroleum competitors:		
Size:		
Small	3.6a*	1.3
Medium	3.8a	1.0
Large	6.9 b	0.9

Means with different letters are significantly different.

^a Seed operation (4); agrichemicals; consulting services; and milling.

* P<0.05, t-test

** P<0.01, t-test

Table 9. Number of farmers selling farm-stored wheat and amount purchased.

Factor	Mean No. Farmers	Mean No. Bushels	Percent of Capacity
Overall	23.9	68,444	9.4
Ownership:			
Cooperative	30.6	84,429	10.5
Independent	8.5	32,841	7.0
Level:			
Headquarters	38.4**	104,171**	12.9*
Branch	9.8	33,708	6.0
District:			
Northwest	30.8	157,500a*	17.5
West	26.2	154,000a	18.4
Southwest	8.4	19,182 b	1.6
North Central	45.6	122,857a	11.1
Central	30.9	67,125ab	11.3
South Central	14.9	33,227 b	6.8
Region:			
North	38.8	138,846a*	14.0a*
Central	29.9	84,500 b	12.7a
South	12.8	28,545 c	5.1 b
Zone:			
West	19.0	87,545	9.8
Central	26.0	59,867	9.3
Size:			
Small	9.5	29,750a*	11.1
Medium	31.0	69,891ab	10.4
Large	28.0	94,893 b	7.4

Means with different letters are significantly different.

* P<0.05, t-test

** P<0.01, t-test

Table 10. Disposition of wheat.

Factor	Destination of Wheat Shipped (%)		
	Other Elevators	Flour Mills	Feed-lots
Overall (N=67)	49	39	12
Ownership:			
Cooperative	48	42	10
Independent	53	33	16
Level:			
Headquarters	44	46	10
Branches	54	34	14
District:			
Northwest	50a*	44	8 b*
West	20 b	61	19ab
Southwest	30ab	35	36a
North Central	77a	21	2 b
Central	56a	41	7 b
South Central	54a	41	5 b
Region:			
North	65	31	4
Central	48	45	9
South	45	39	17
Zone:			
West	32**	43	26**
Central	58	38	5
Size:			
Small	68a**	28	10
Medium	46a	41	31
Large	39 b	46	30

Means with different letters are significantly different.

* P<0.05, t-test

** P<0.01, t-test

Table 11. Discounts reported by elevators for live insects.

Factor	Mean	Deviation
Overall (N=55)	4.4	2.4
Ownership:		
Cooperative	4.7	0.4
Independent	3.3	0.7
Level:		
Headquarters	4.6	0.5
Branch	4.2	0.5
Region:		
North	2.7a**	0.6
Central	5.0 b	0.6
South	4.8 b	0.4
Zone:		
West	3.5*	0.5
Central	4.8	0.4
Size:		
Small	4.5	0.6
Medium	4.4	0.6
Large	4.3	0.5

Means with different letters are significantly different.

* P<0.05, t-test

** P<0.01, t-test

Table 12. Ranking of factors considered in determining discounting policy.

Factor	Order of Importance				Weighted Score ^a
	First (%)	Second (%)	Third (%)	Fourth (%)	
Competition (N=66)	33	30	35	2	195
Pass discounts (N=66)	56	30	14	0	226
Wheat quality(N=66)	8	44	46	2	163
Other (N=10)	60	10	20	10	34
Competition:					
Size:					
Small	26	16	53	5*	
Medium	16	47	37	0	
Large	50	29	21	0	
Pass on discounts:					
Ownership:					
Cooperative	61	33	7	0*	
Independent	45	25	30	0	
Size:					
Small	61	33	6	0*	
Medium	80	15	5	0	
Large	36	39	25	0	
Average wheat quality:					
District:					
Northwest	0	20	80	0*	
West	25	0	50	25	
Southwest	0	80	20	0	
North Central	0	50	50	0	
Central	11	44	44	0	
South Central	10	40	50	0	

^a Weighting scheme: first place=4, second=3, third=2, fourth=1; weighted scores are summed with the highest having the greatest importance.

* P<0.05, χ^2 test

Table 13. Ranking of factors considered in adapting discounting policy.

Factor	Order of Importance				Weighted Score ^a
	First (%)	Second (%)	Third (%)	Fourth (%)	
Elevator circumstances (N=19)	42	21	26	11	56
Grain business from customer (N=19)	32	37	26	5	56
Other business from customer (N=18)	11	33	44	11	44
Other (N=11)	64	18	9	9	37
Amount of grain business:					
Ownership:					
Cooperative	50	42	0	8**	
Independent	0	29	71	0	
Amount of other business from customer:					
Ownership:					
Cooperative	0	42	58	0*	
Independent	33	17	17	33	

^a Weighting scheme: first place=4, second=3, third=2, fourth=1; weighted scores were summed with the highest having the greatest importance.

* P<0.05, χ^2

** P<0.01, χ^2

Table 14. Sample characteristics associated with price discounts at nine country and five terminal elevators.

Factor	Range	Percent Lots Receiving Discount	
		1986	1991
Test weight (lb/bu)	≤ 58.0	71.8**	100.0*
	58.1–59.9	63.5	70.0
	≥ 60.0	7.3	18.8
Dockage (%)	0.0–0.5	46.4**	31.5**
	0.6–0.9	63.0	46.2
	≥ 1.0	76.3	81.3
Infestation	No	56.8	35.2**
	Yes	65.3	63.6
Infestation density (number/1000 g)	0.0	56.8	35.2**
	0.1–5/0	61.6	60.0
	≥ 5.0	75.8	70.0

* P<0.05, χ^2 test

** P<0.01, χ^2 test

N = 465 in 1986, 249 in 1991

Table 15. Size, location, and ownership of country elevators surveyed, 1986 and 1991.

Factor	1991 Number Sites	1986 Number Sites	% Decrease 1986 to 1991	% Country Elevators Surveyed 1991
Overall	72	85	-15	28
Ownership:				
Cooperative	49	54	-9	37 **
Independent	23	31	-35	18
Level:				
Headquarters	35	-	-	-
Branch	37	-	-	-
District:				
Northwest	6	8	-25	25
West	5	8	-38	25
Southwest	12	13	-8	34
Northcentral	7	10	-30	23
Central	20	24	-17	27
Southcentral	22	22	0	30
Region:				
North	13	18	-28	24
Central	25	32	-22	27
South	34	35	-3	31
Zone:				
West	23	29	-21	29
Central	49	56	-12	28
Size:				
Small	20	40	-50	18**
Medium	23	24	-4	34
Large	29	21	+38	38

** P<0.01, χ^2 test

Table 16. Mean grain storage capacity of sampled elevators.

Factor	Mean	Standard Deviation
Overall	1,014,000	909,000
Ownership:		
Cooperative	983,000	131,000
Independents	1,079,000	191,000
Level:		
Headquarters	1,117,000	154,000
Branch	917,000	150,000
District:		
Northwest	899,000 b*	350,000
West	903,000 b	383,000
Southwest	1,839,000a	247,000
North Central	834,000 b	324,000
Central	941,000 b	192,000
Southwest	744,000	183,000
Region:		
North	864,000	254,000
Central	934,000	183,000
South	1,130,000	157,000
Zone:		
West	1,391,000*	183,000
Central	837,000	125,000
Size:		
Small	290,000a*	150,000
Medium	723,000 b	139,000
Large	1,743,000 c	300,000

Means with different letters are significantly different.

* P<0.05, t-test

Table 17. Method of fumigating wheat, as reported by elevator managers.

Factor	Percent Fumigation		
	While Turning	In-Bin	Other
Size:			
Large	93	7	0**
Medium	83	13	4
Small	50	40	10
Region:			
North	46	46	8*
Central	84	12	4
South	85	12	3

* P<0.05, χ^2 test

** P<0.01, χ^2 test

Table 18. Sampling procedures when shipping wheat by truck and rail.

Factor	% Truck Shipments (N=70)			% Rail Shipments (N=64)		
	Do Not Sample	Sample Some	Sample All	Do Not Sample	Sample Some	Sample All
Overall:						
Percent	23	30	47	3	6	91
Number	16	21	33	2	4	58
Ownership:						
Cooperative	26	32	43	2	7	91
Independent	17	26	57	5	5	89
Level:						
Headquarters	32	29	38	3	9	89
Branch	14	31	56	3	3	93
District:						
Northwest	50	33	17	0	17	83
West	0	0	100	0	0	100
Southwest	8	25	67	0	8	92
Northcentral	29	57	14	0	0	100
Central	16	32	53	0	12	88
Southcentral	32	27	41	11	0	89
Region:						
North	38	46	15	0	8	92
Central	13	26	61	0	10	90
South	24	26	50	7	3	90
Zone:						
West	18	23	59	0	9	91
Central	25	33	42	5	5	90
Size:						
Small	20	40	40	8	8	84
Medium	27	32	41	0	9	91
Large	21	21	57	3	3	93

Table 19. Average number of adult insects (all species) captured per bait trap over the duration of the study.

Trap Location	Elevators with Feed Mills	Elevators without Feed Mills
Feed mill	120.9 ± 25.4 b	—
Belowground	216.4 ± 27.1a	436.4 ± 52.1a**
Ground level	56.0 ± 43.9 b	114.0 ± 62.8 b
Upper level	84.0 ± 28.3 b	96.6 ± 43.8 b
All locations	130.3 ± 20.1	201.2 ± 22.9

Means with different letters are significantly different.
** P<0.01, t-test

Table 20. Change in insect presence and deterioration in wheat stored on farms and in elevators.

Factor	Farm ^a		Elevator ^b	
	% Lots	Mean Increase	% Lots	Mean Increase
	<i>number/1000 g</i>			
Live internal insects	53.8	0.4*	9.7	0.3
Live external insects	69.2	4.2*	19.4	0.3*
Any live insects	76.9	4.6*	22.6	0.6
Insect-damaged kernels ^c	0	0	29.0	5.8*
Internally infested kernels ^d	38.5	10.8	22.6	2.6
Degermed kernels	61.5	13.1**	29.0	7.7**

^a Mean storage time = 4.0 months

^b Mean storage time = 7.6 months

^c IDK determined according to FDA definition

^d Internal infestation determined by x-ray technique

* P<0.05

** P<0.01

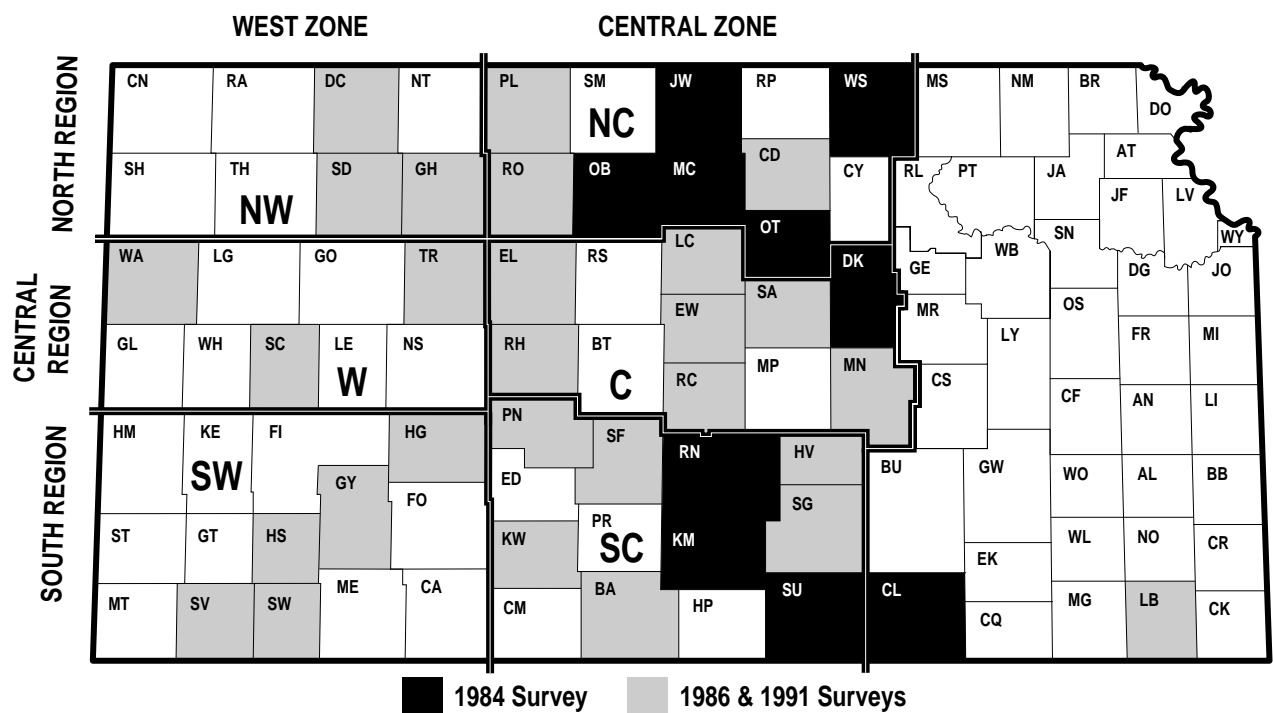

Figure 1. Map of study area with counties selected for producer and elevator manager surveys.

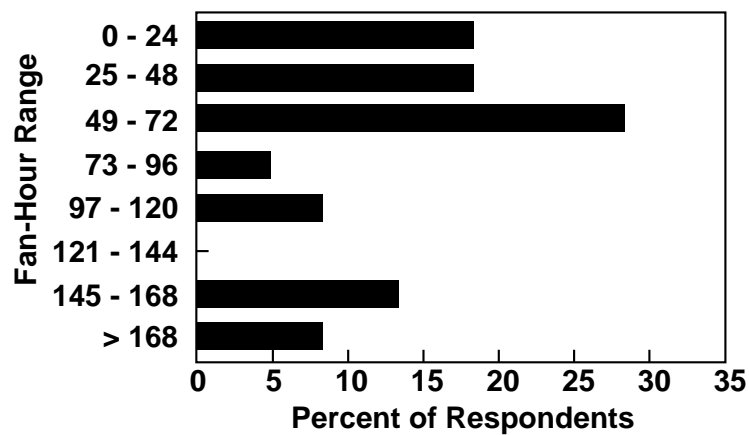

Figure 2. Percent of farmer respondents reporting various ranges of total fan hours to cool farm-stored wheat.

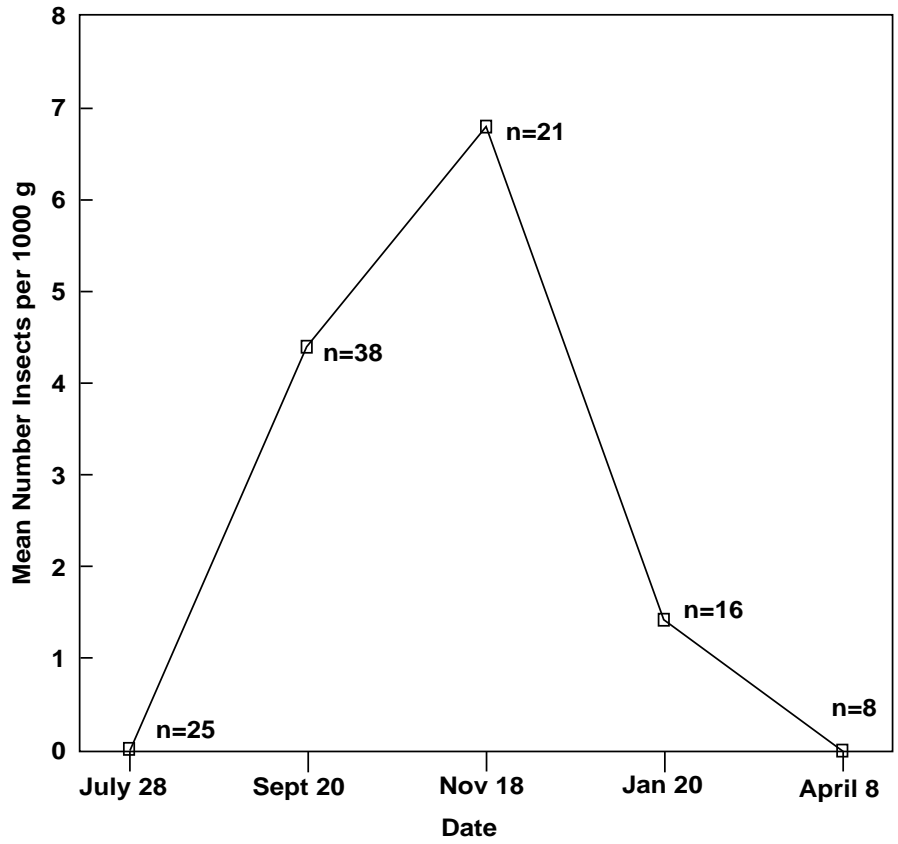

Figure 3. Mean number of live adult insects of all species per 1000 g of sample in lots of untreated farm-stored wheat, 1986-1987.

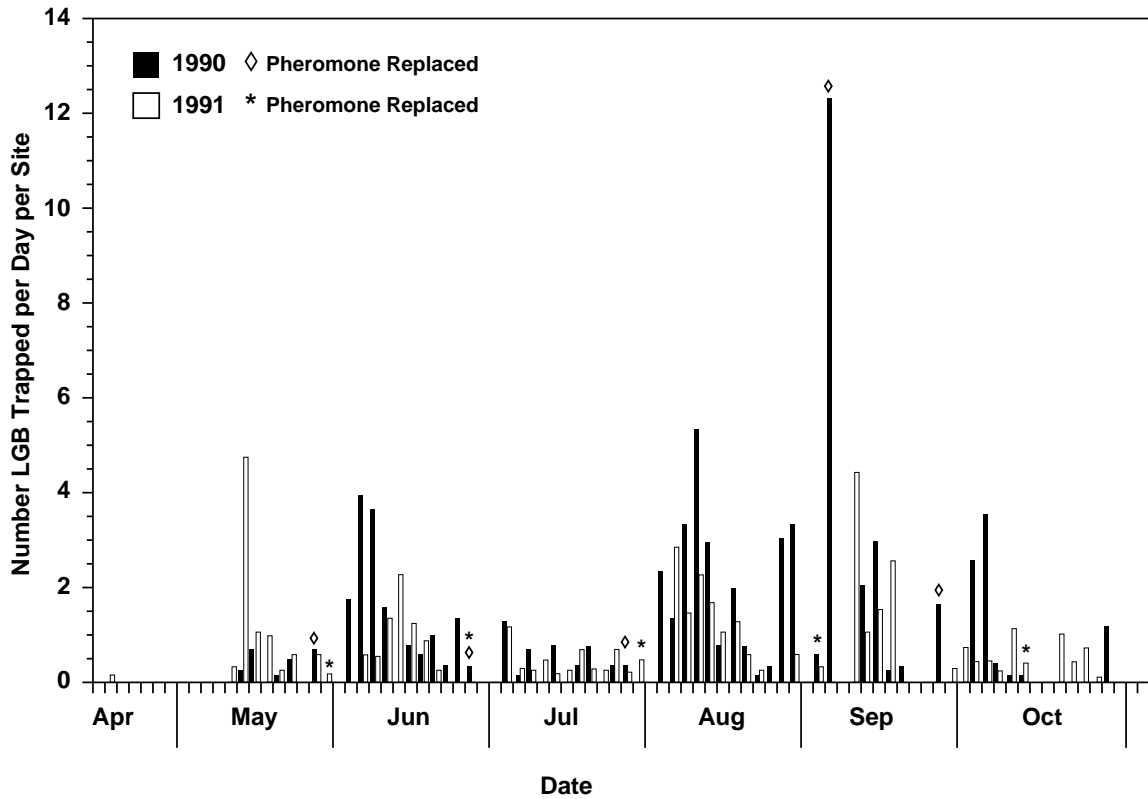

Figure 4. Mean number of lesser grain borer adults captured in pheromone-baited flight traps in northeast Kansas in 1990.

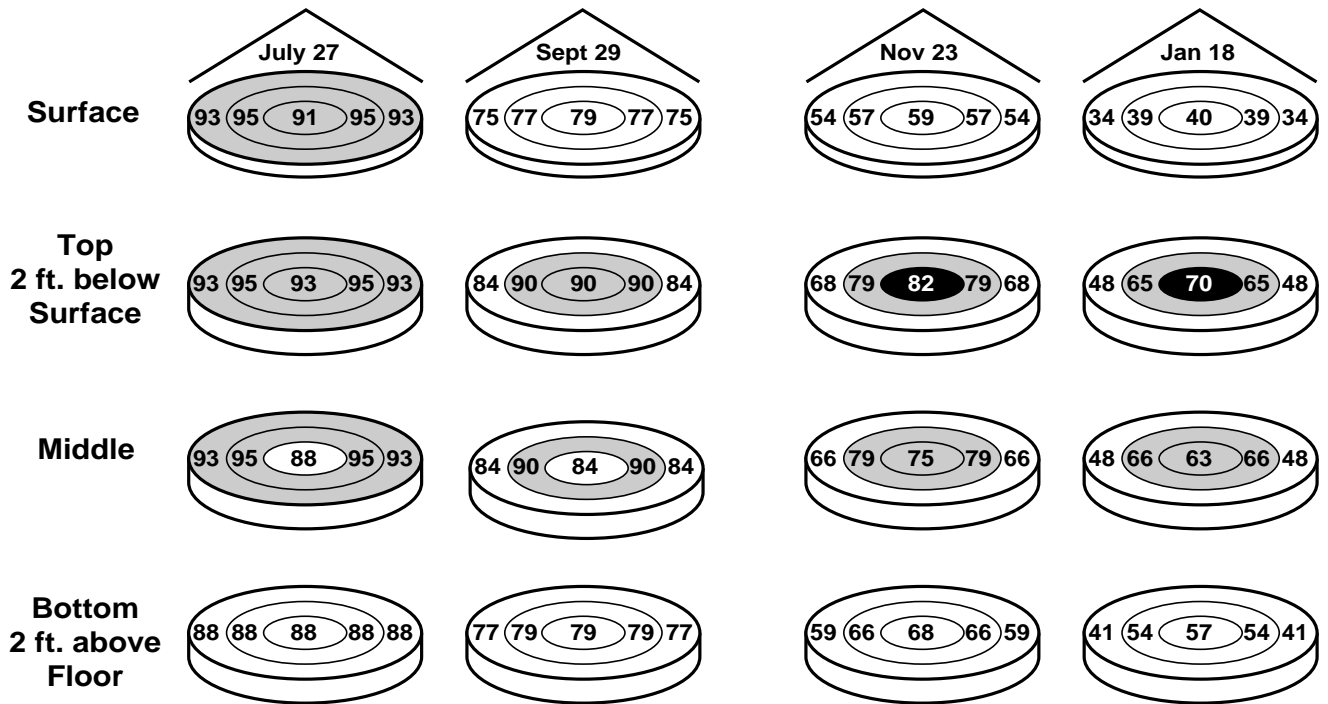

Figure 5. Mean temperatures at various points within six lots of farm-stored wheat from 1987 harvest.

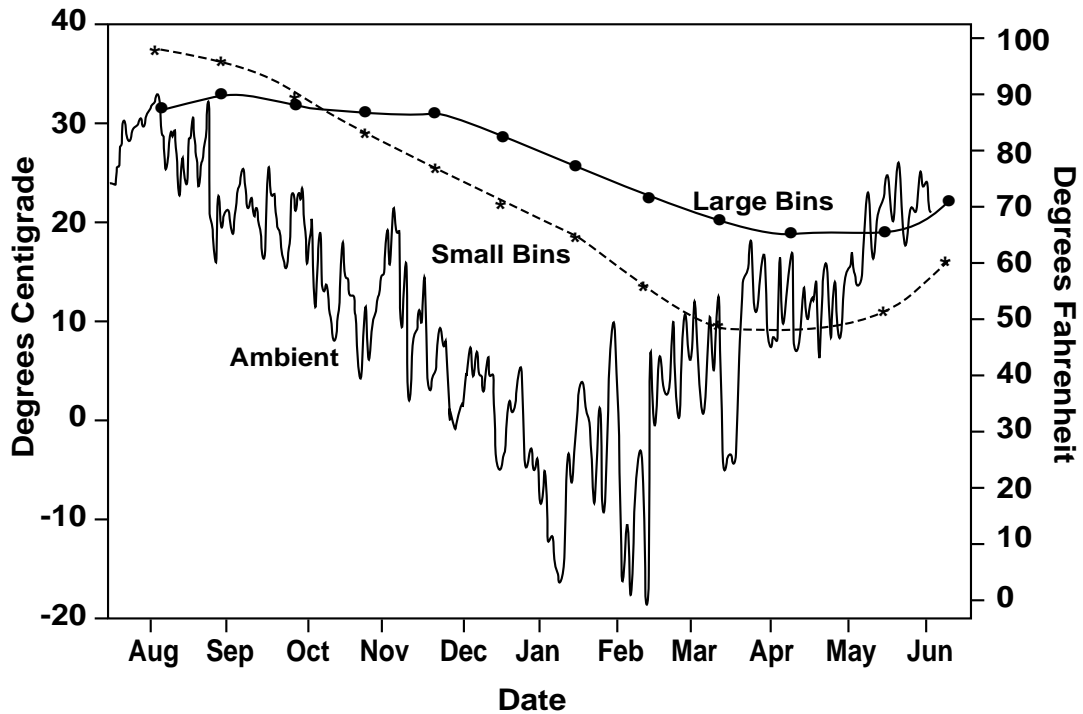

Figure 6. Mean daily ambient temperature and mean temperature at the warmest place in three large (26 - 30 ft, 10,000 bu) bins and three small (14 - 18 ft, 1200 - 3,500 bu) bins of unaerated farm-stored wheat in north-central Kansas, 1987-1988.

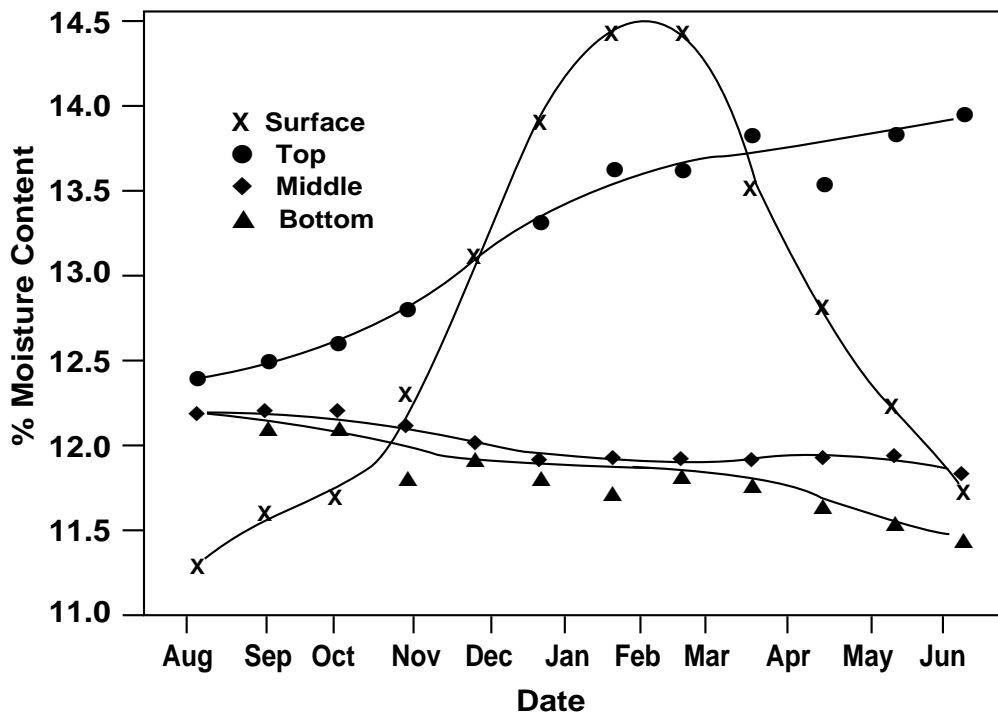

Figure 7. Mean moisture content (% w.b.) at the surface, top (2 ft below the surface), middle (half-way between the surface and the bin floor), and bottom (2 ft above the bin floor) in six bins of unaerated farm-stored wheat in north-central Kansas, 1987-1988.

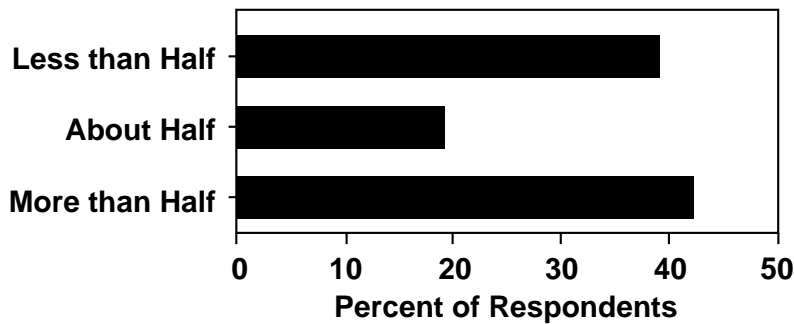

Figure 8. Percent of farmer respondents that indicated delivering various proportions of the crop to elevators at harvest time.

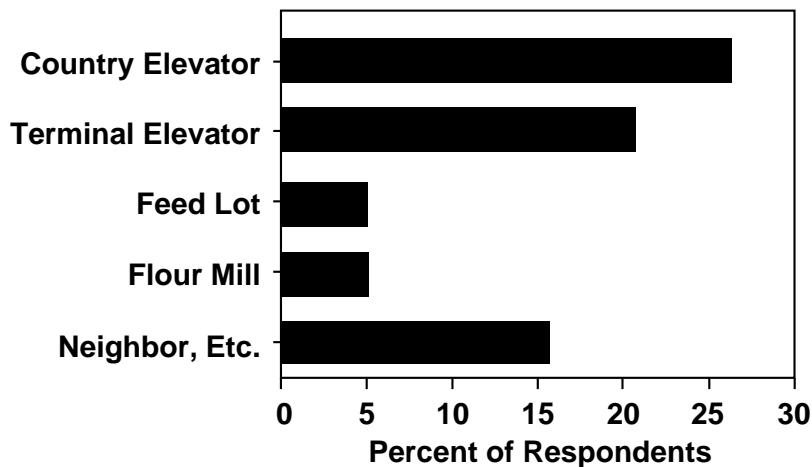

Figure 9. Percent of farmer respondents indicating a certain delivery site for farm-stored wheat.

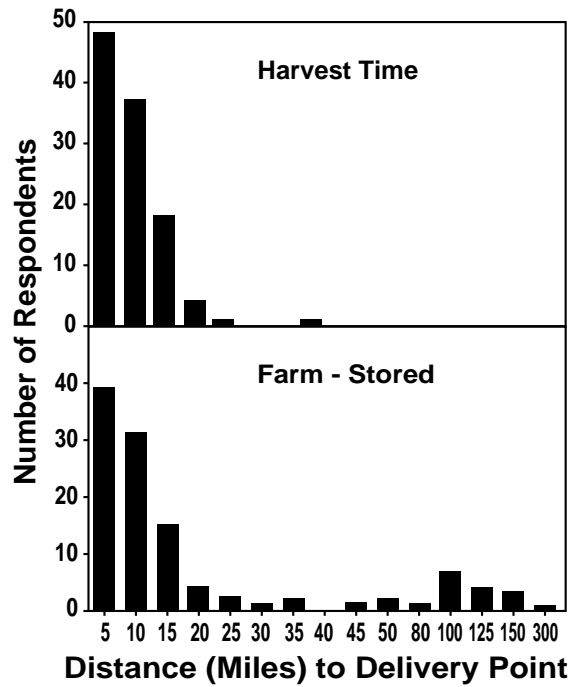

Figure 10. Number of farmer respondents indicating a certain range of distance that wheat is transported for delivery at harvest and after farm storage.

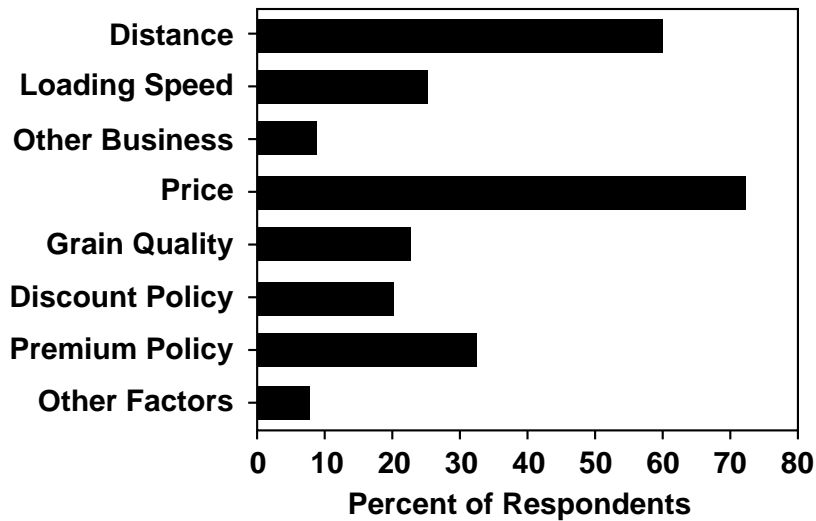

Figure 11. Percent of farmer respondents indicating that a certain factor was important in their choice of delivery sites.

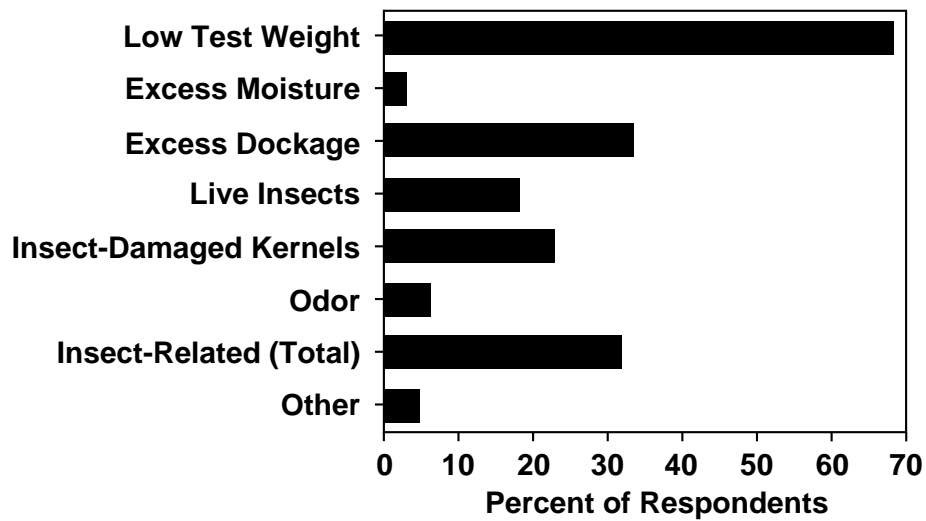

Figure 12. Percent of farmer respondents indicating a certain reason for discounts in farm-stored wheat.

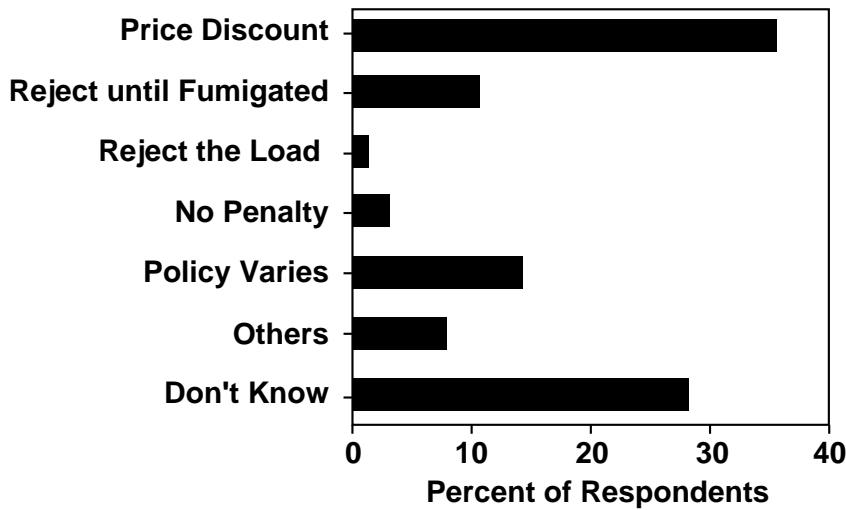

Figure 13. Farmers' perception of the policy toward infested farm-stored wheat at the site where they usually deliver.

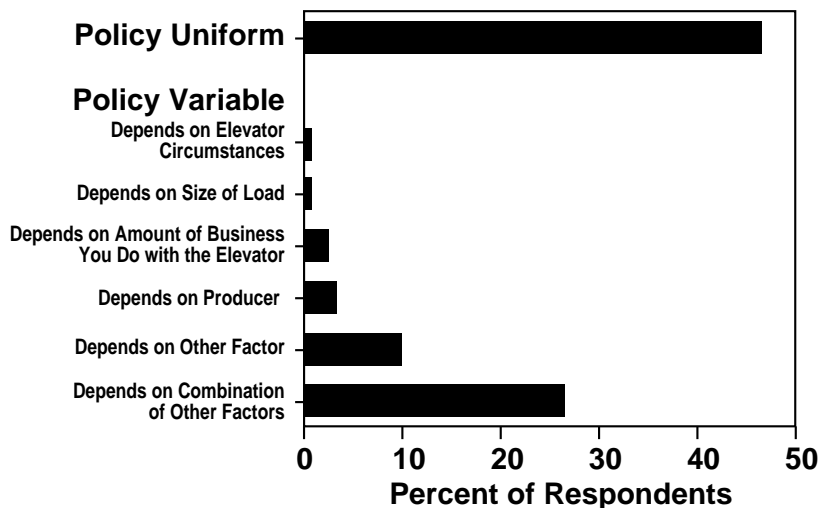

Figure 14. Farmers' perception of the reason for the insect discount policy at the site where they usually deliver farm-stored wheat.



Figure 15. Quantities of farm-stored wheat purchased in 1990, as reported by elevator managers.

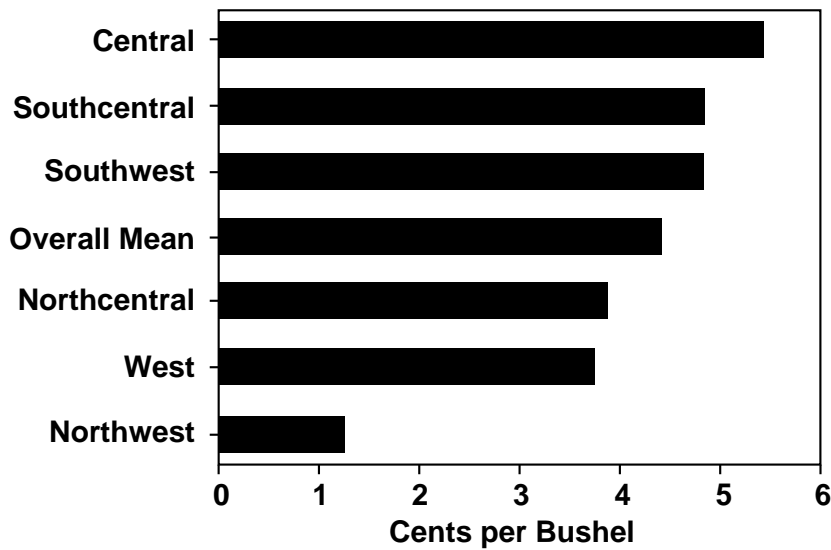

Figure 16. Mean discounts for infested farm-stored wheat, as reported by elevator managers.

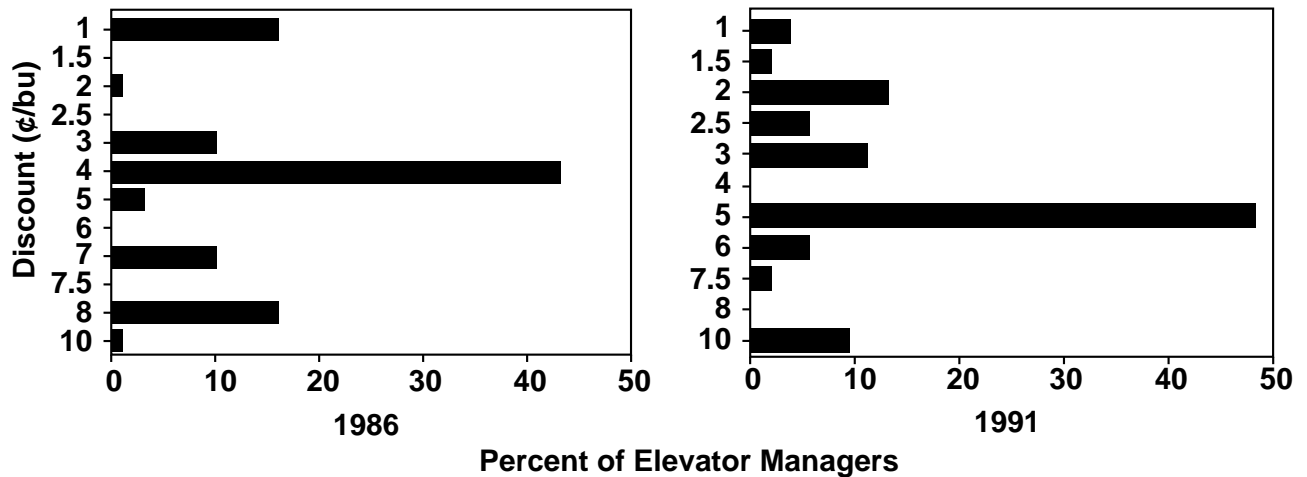

Figure 17. Percent of responding elevator managers who reported a certain value of discounts for infested farm-stored wheat.

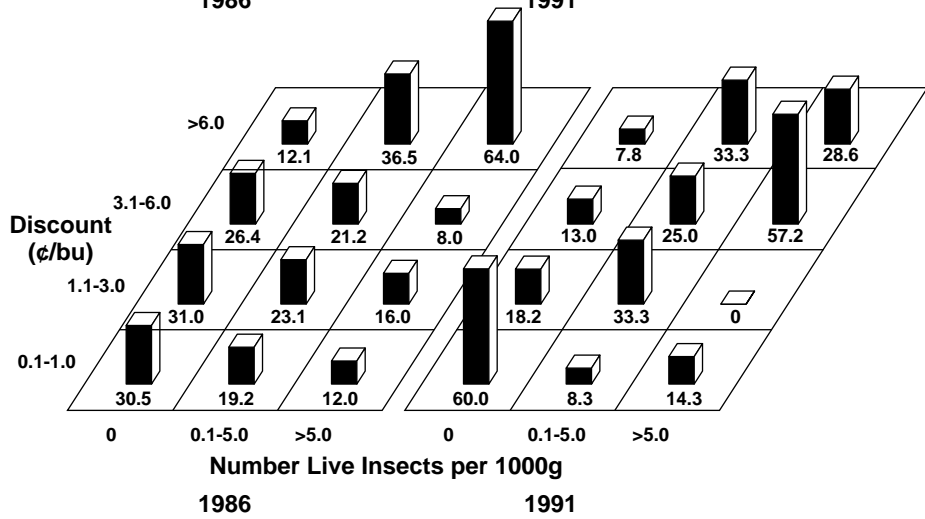
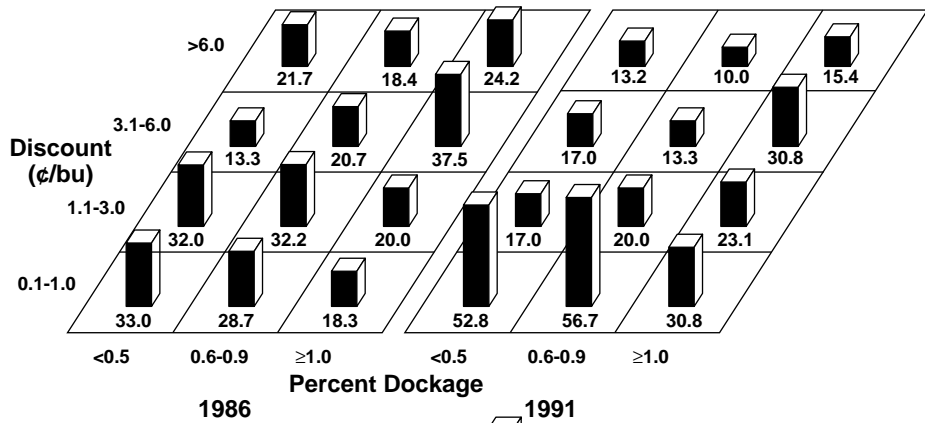
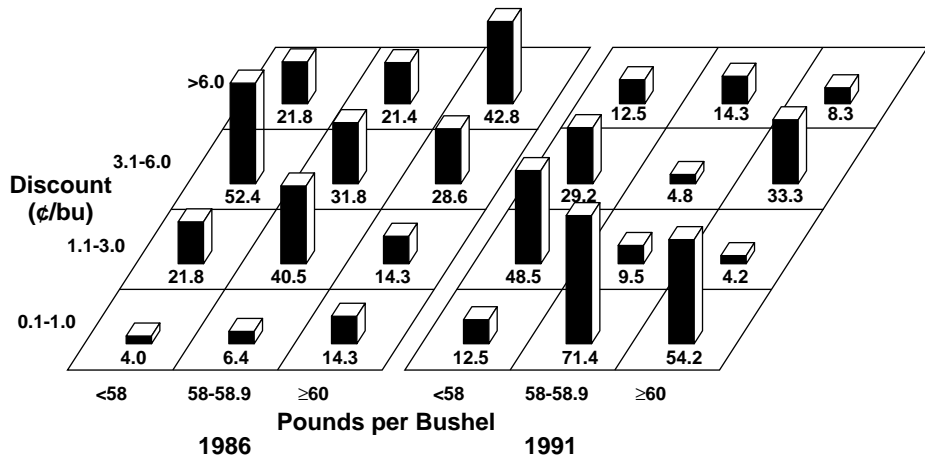

Figure 18. Range of discounts applied in 1986 and 1991, based on samples of farm-stored wheat arriving at elevators.

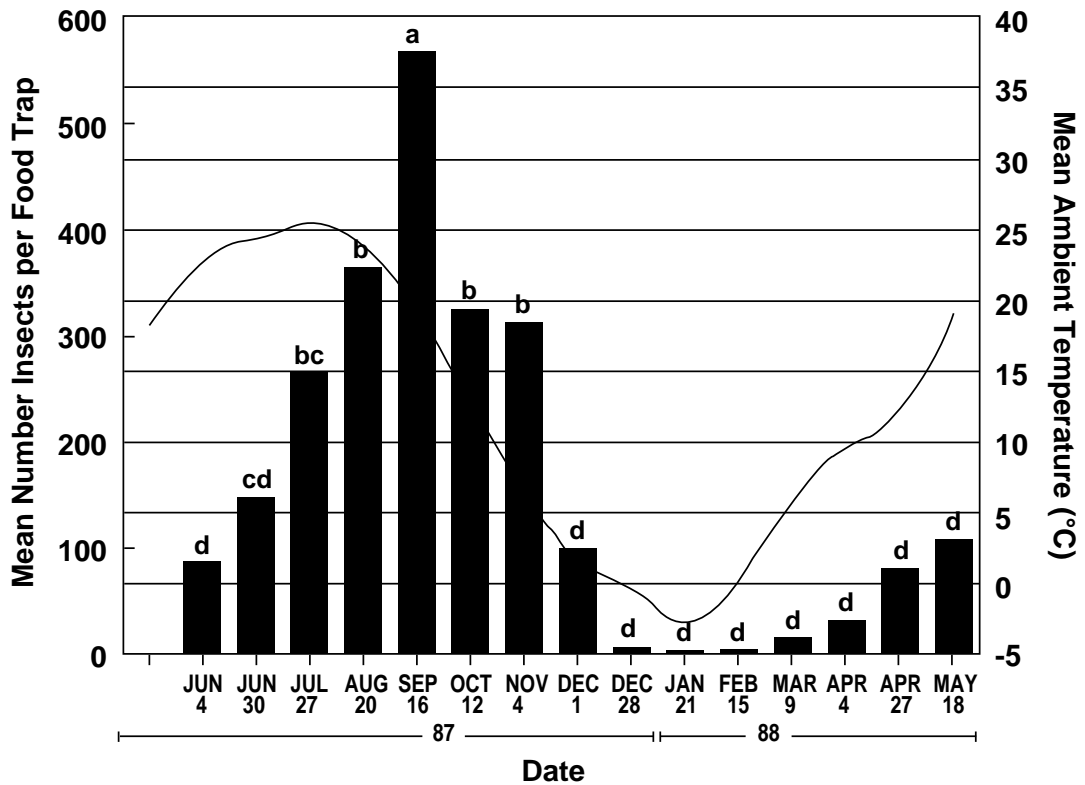

Figure 19. Mean number of live adult insects of all species per food trap over all elevators and locations within each elevator.

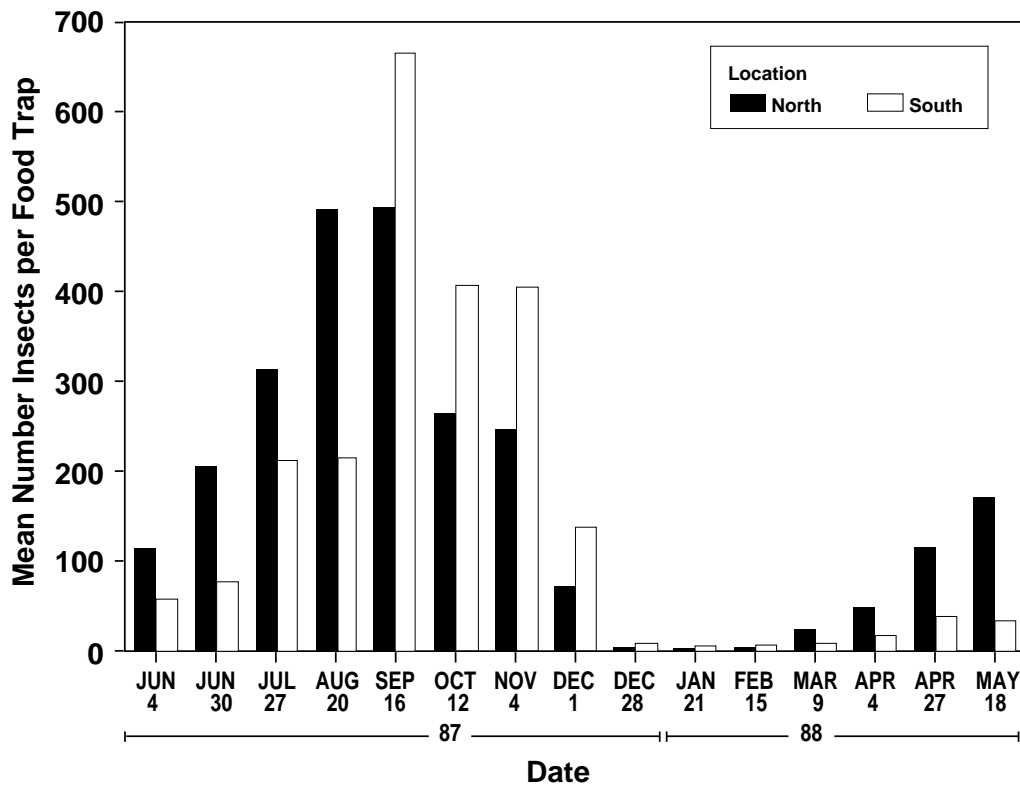

Figure 20. Mean number of live adult insects of all species per food trap over all locations within each elevator, by geographic location.

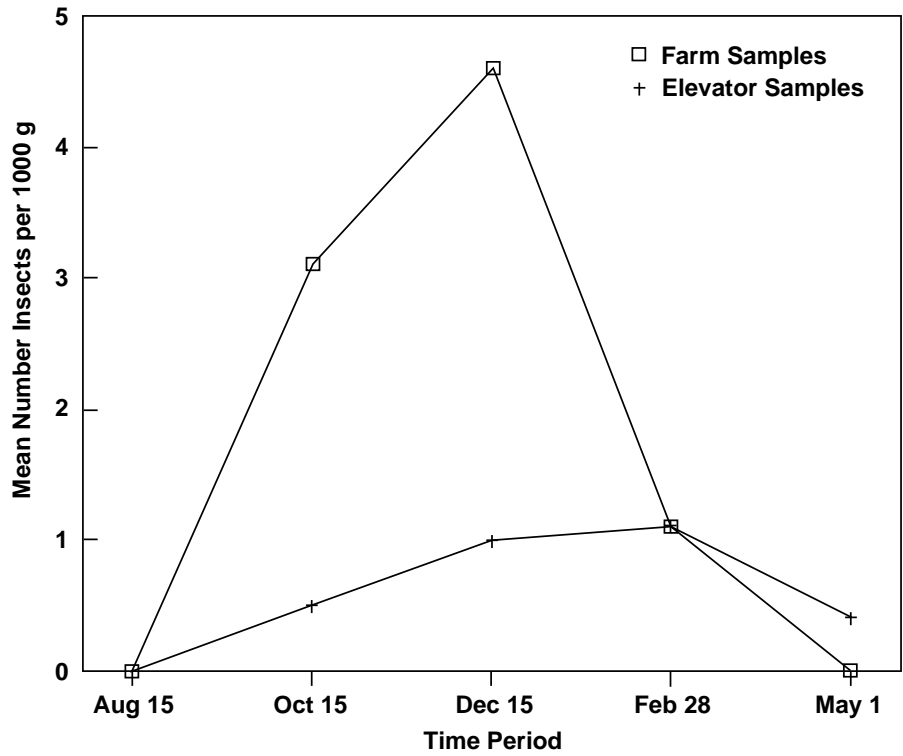

Figure 21. Mean live total insects in wheat samples from farm and elevator storage over time.

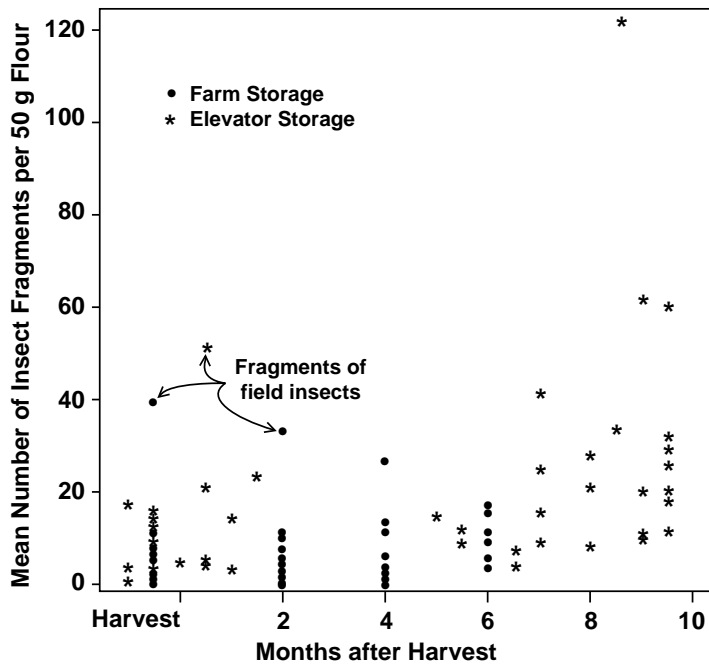

Figure 22. Insect fragments in flour milled from wheat stored for various periods on farms and in elevators.

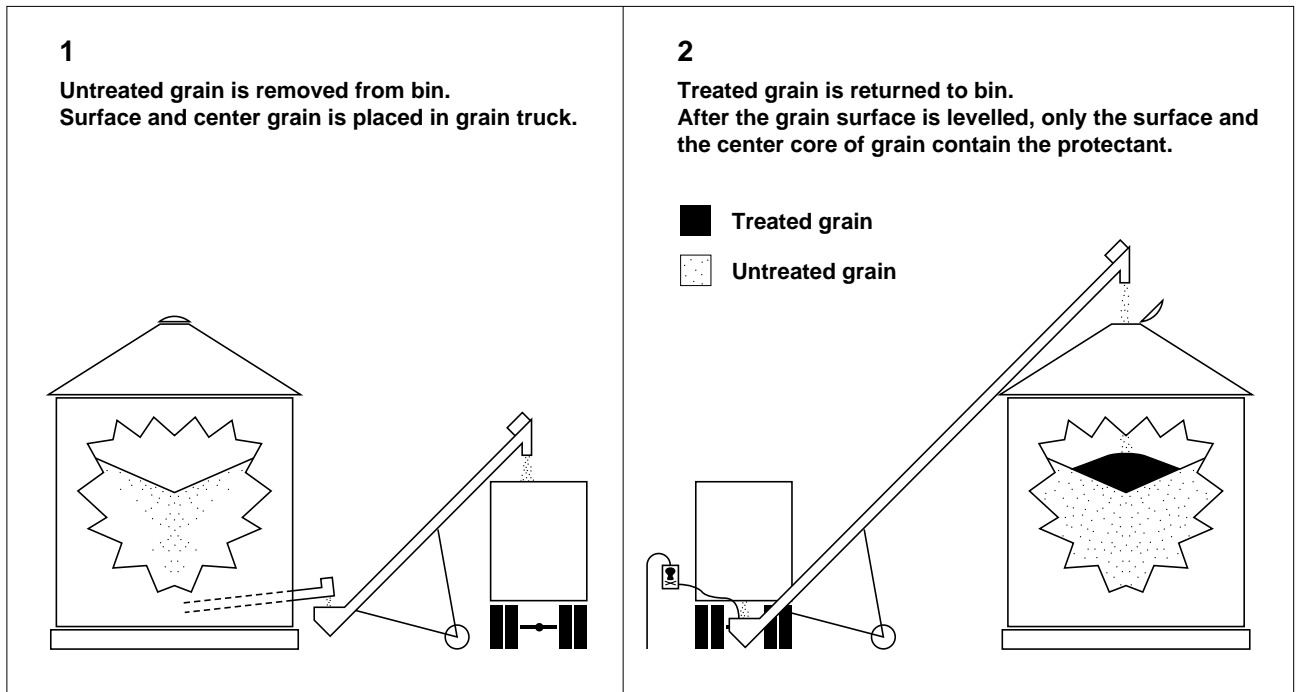

Figure 23. Illustration of delayed treatment with protectant.

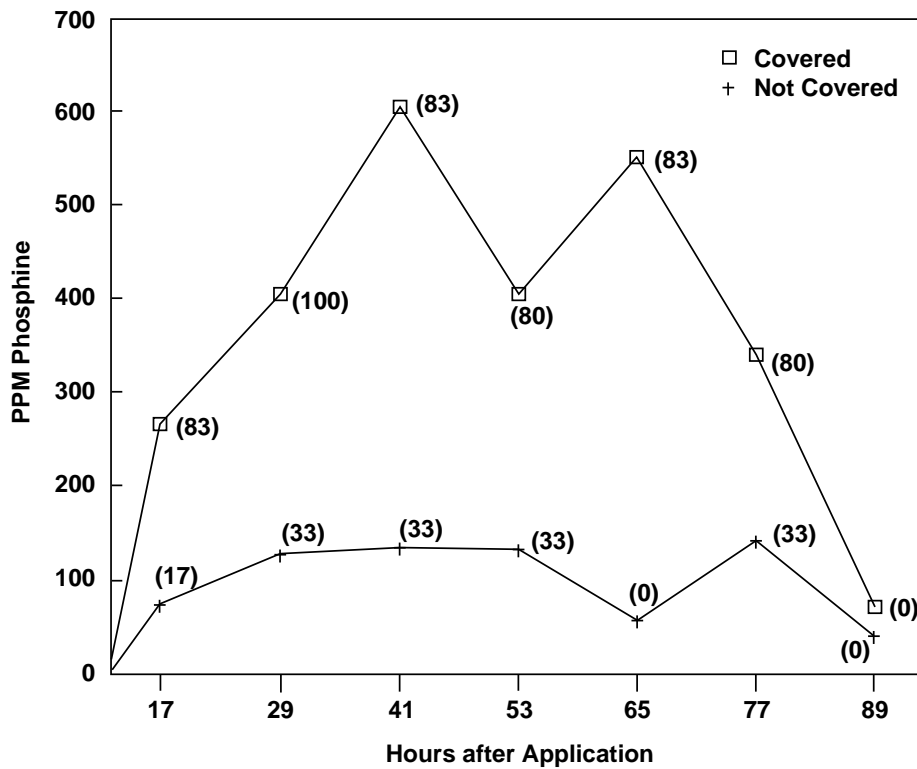

Figure 24. Mean concentration of phosphine gas within paired 1000 - bushel bins when fumigant was probed into the grain and the grain surface of one bin was covered with a plastic tarpaulin. Numbers in parentheses are percentages of sampling points where the phosphine concentration exceeded 200 ppm.

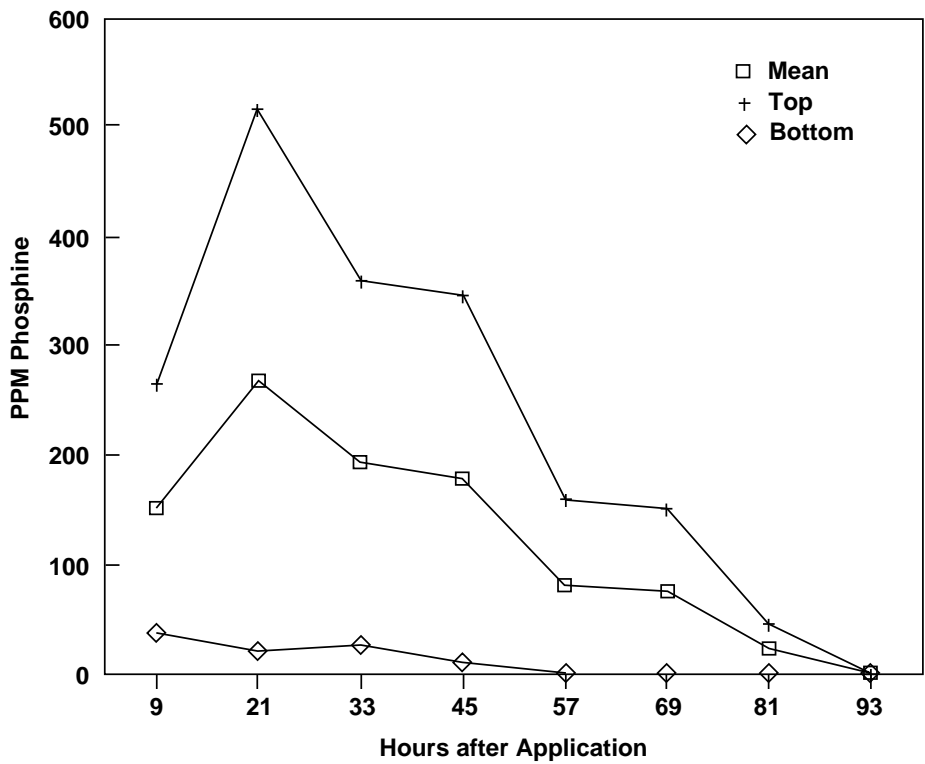

Figure 25. Distribution of phosphine gas when fumigant was probed into a 1000-bushel lot of wheat and the grain surface was not covered.

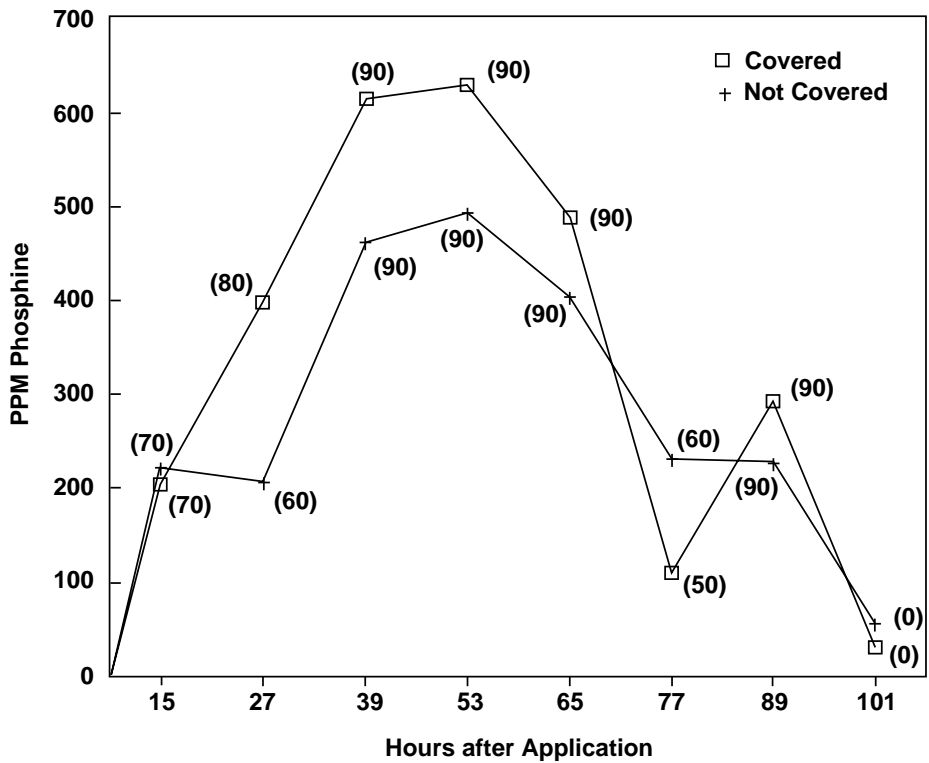

Figure 26. Mean concentration of phosphine gas within paired 1000-bushel bins when the fumigant was applied at ground level and the grain surface in one bin was covered with a plastic tarpaulin. Numbers in parentheses are percentages of sampling points where the phosphine concentration exceeded 200 ppm.

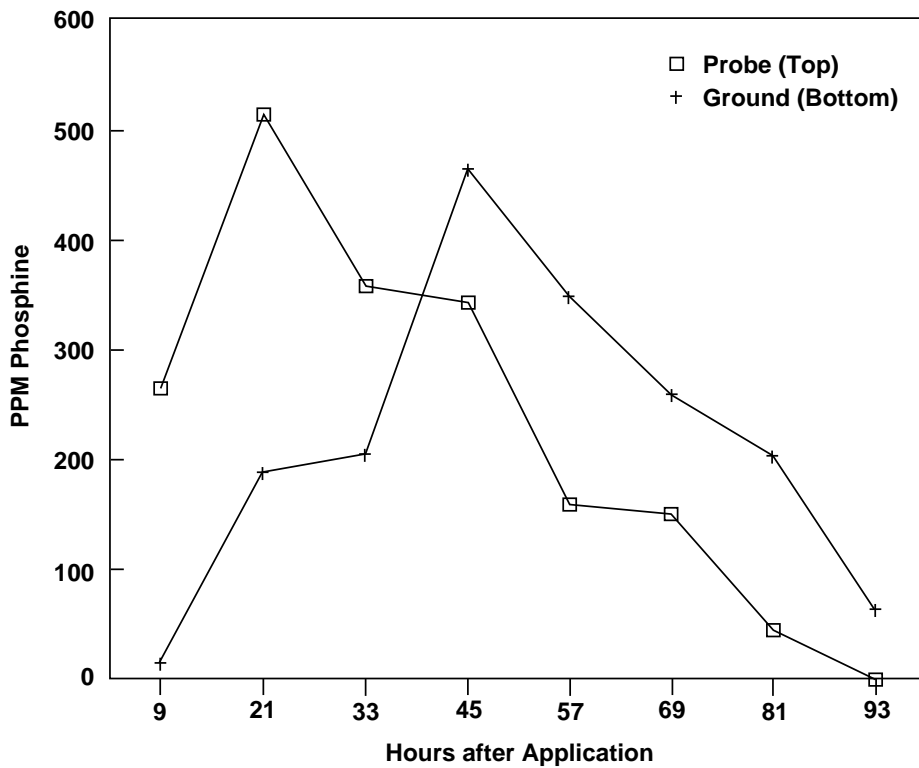

Figure 27. Mean concentration of phosphine gas at the top sampling point in paired 1000-bushel bins when the fumigant was probed into the grain or applied at ground level and the grain surface was not covered.

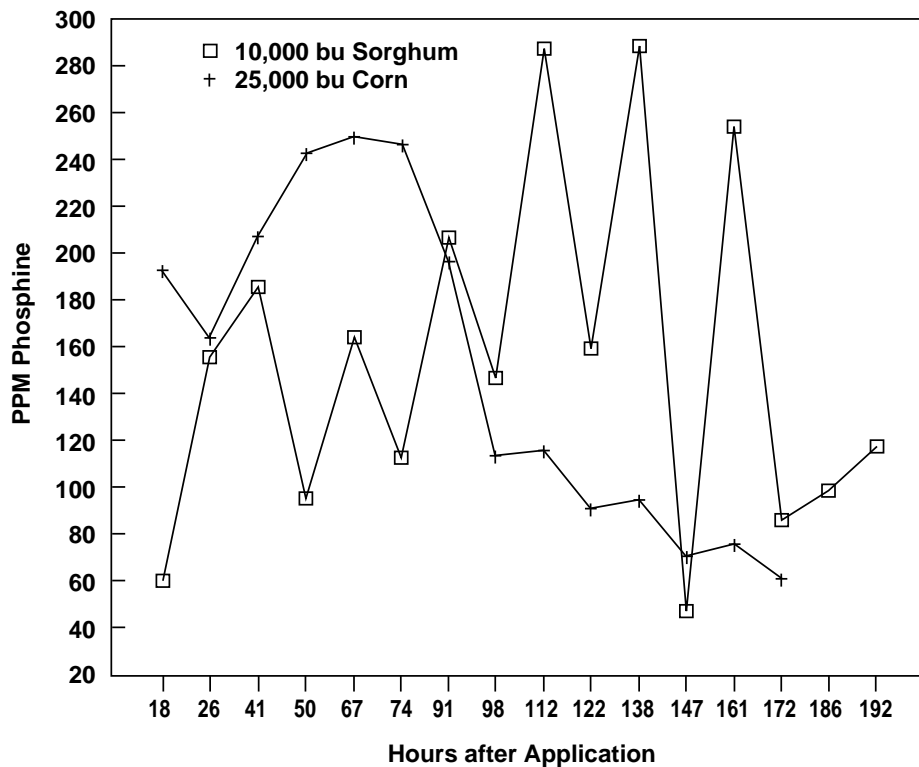

Figure 28. Phosphine gas concentrations (mean of all sampling points) in a 25,000-bushel lot of corn leveled and covered with a plastic tarpaulin and in a 10,000-bushel lot of grain sorghum peaked and not covered when fumigant was applied at ground level.

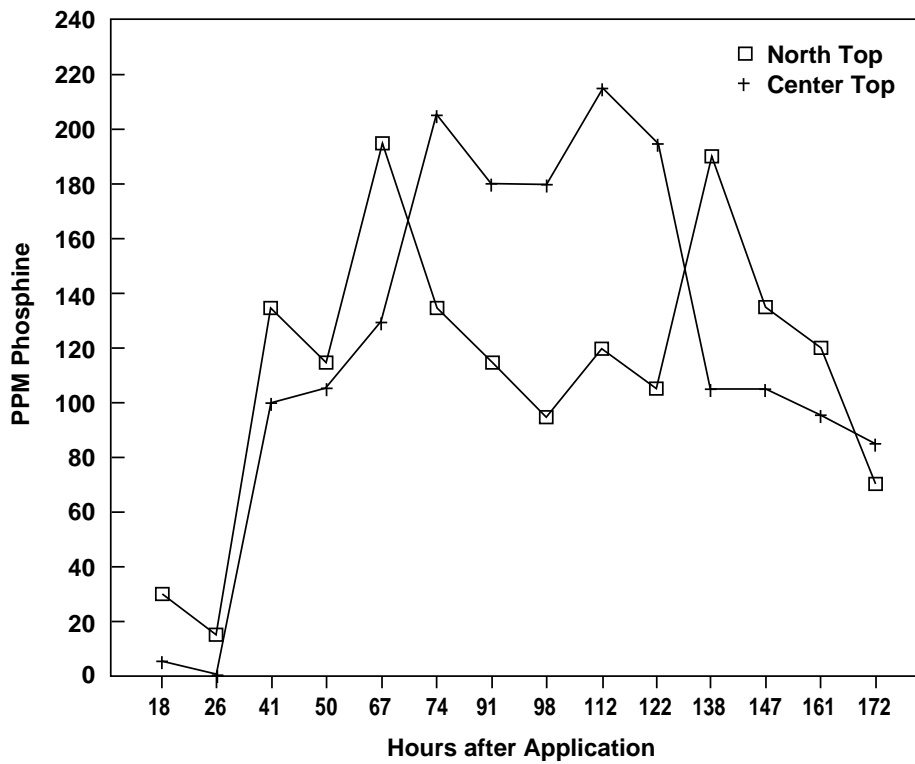

Figure 29. Phosphine gas concentrations at the top sampling points in a 25,000-bushel lot of corn when fumigant was applied at ground level.

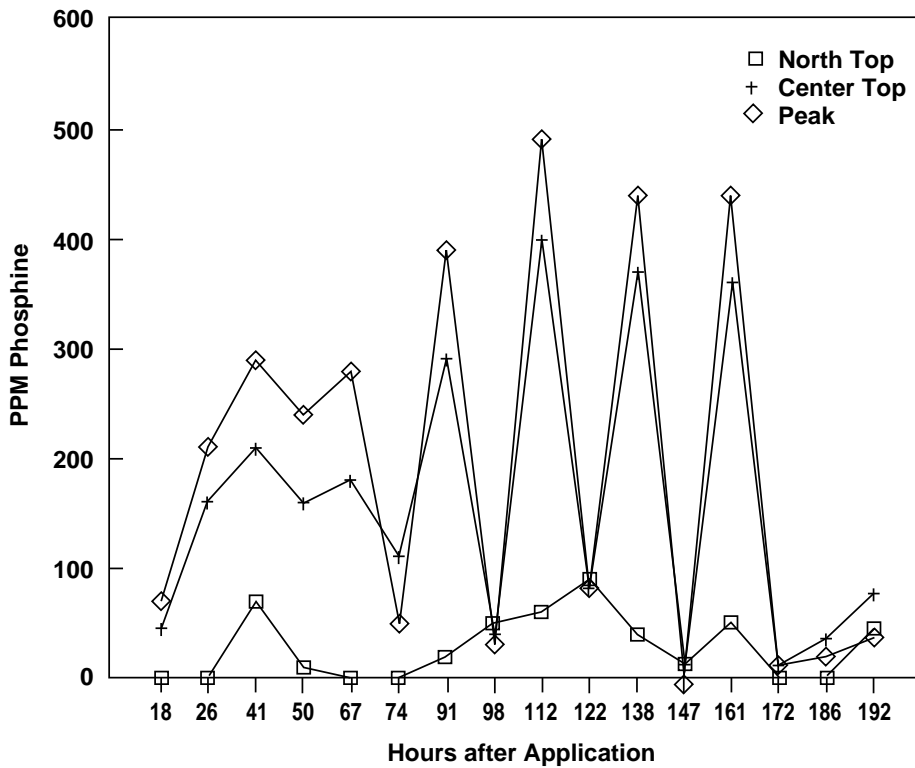

Figure 30. Phosphine gas concentrations at the top sampling points in a 10,000-bushel lot of grain sorghum when fumigant was applied at ground level.

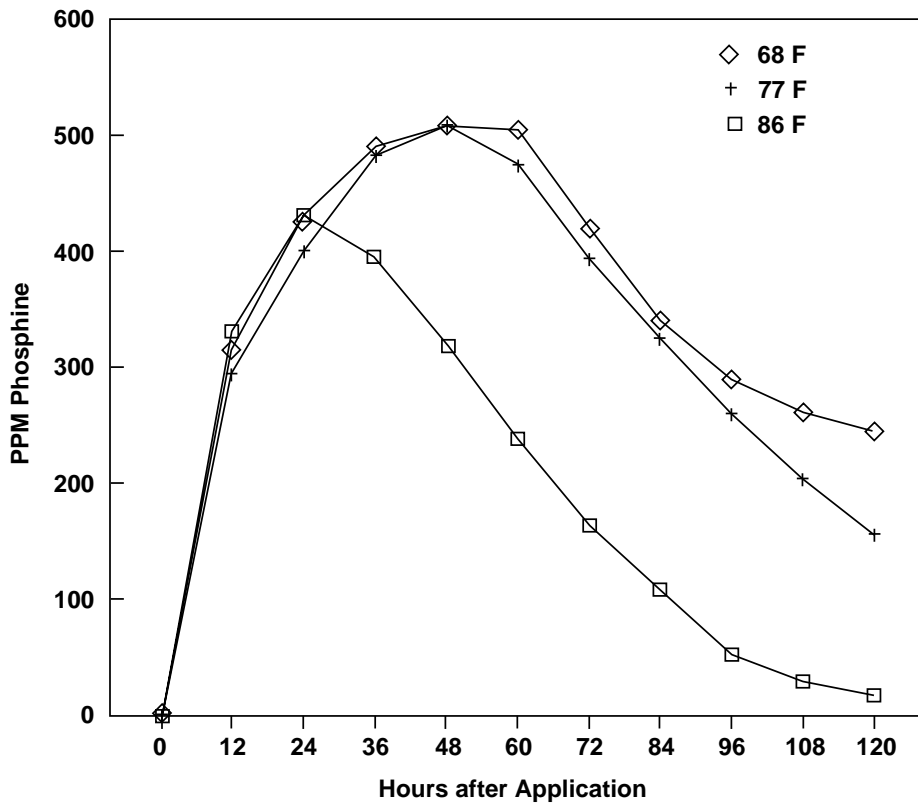

Figure 31. Mean phosphine gas concentrations in six 50-bushel bins of wheat at low, medium, and high temperatures.

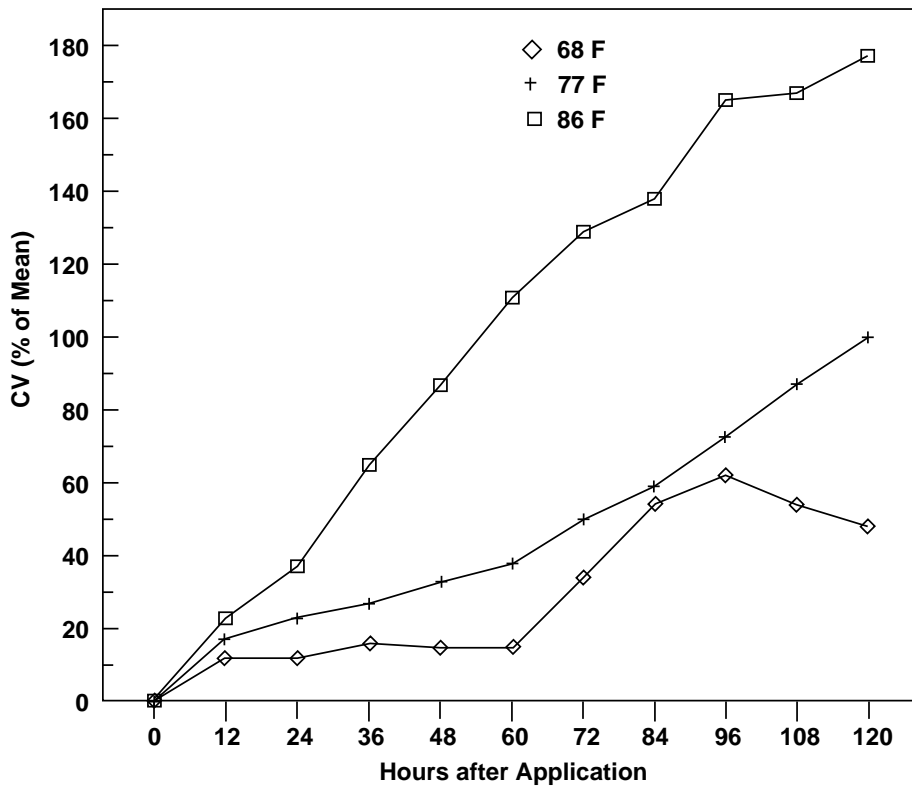

Figure 32. Coefficient of variability (percent of mean gas concentration) among six 50-bushel bins of wheat fumigated at low, medium, and high temperatures.

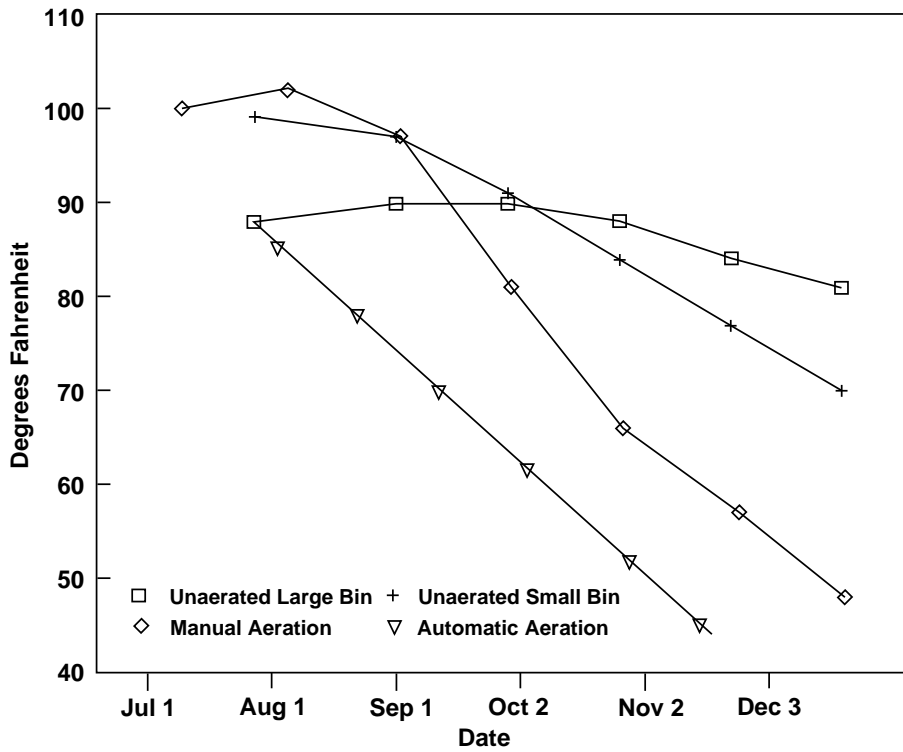

Figure 33. Mean temperature at the warmest place in grain masses cooled without aeration, by manually controlled aeration, and with the assistance of automatic aeration controllers.

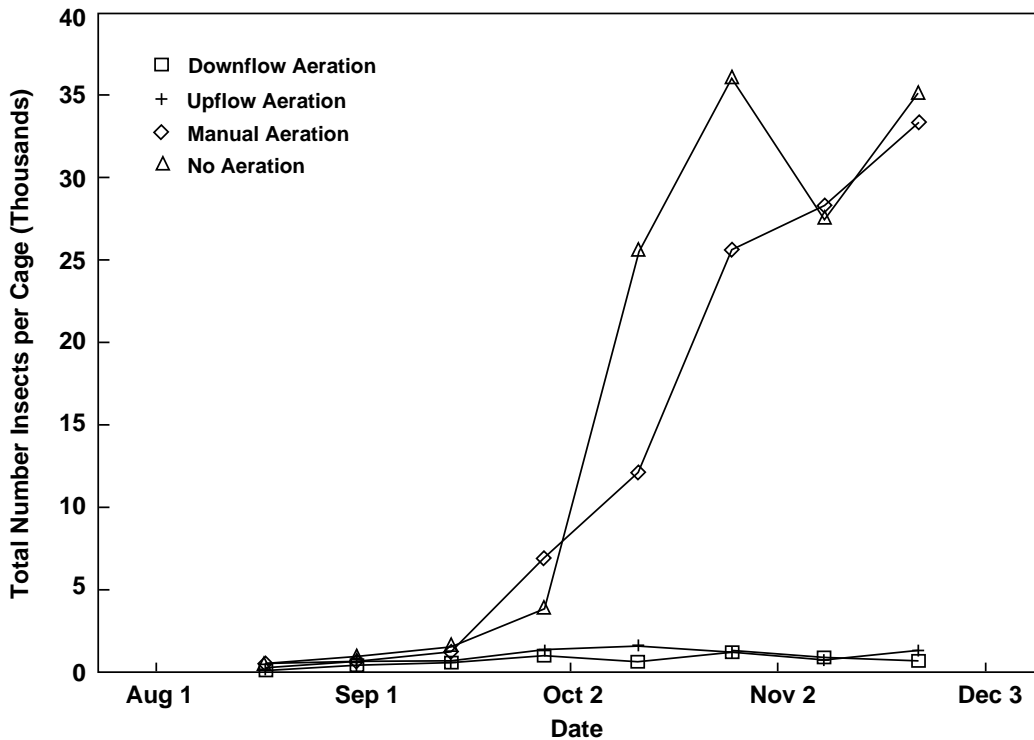

Figure 34. Population of insects in cages containing 2500 g of wheat initially infested with 10 adult lesser grain borers and 10 flat grain beetles through 5 months under no aeration, manually controlled aeration, and automatically controlled aeration.

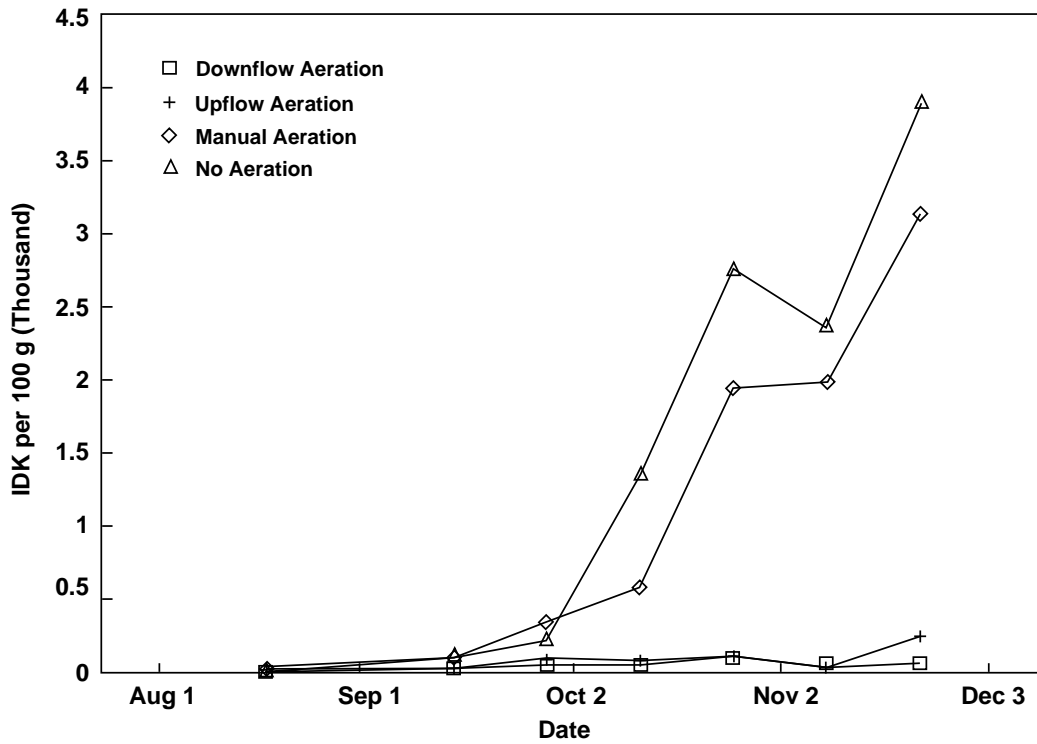

Figure 35. Number of insect-damaged kernels per 100 g in cages containing 2500 g of wheat initially infested with 10 adult lesser grain borers and 10 flat grain beetles through 5 months under no aeration, manually controlled aeration, and automatically controlled aeration.



Agricultural Experiment Station, Kansas State University, Manhattan 66506-4008

Bulletin 660

December 1993

Kansas State University is committed to a policy of non-discrimination on the basis of race, sex, national origin, disability, religion, age, sexual orientation, or other non-merit reasons, in admissions, educational programs or activities, and employment, all as required by applicable laws and regulations. Responsibility for coordination of compliance efforts and receipt of inquiries, including those concerning Title IX of the Education Amendments of 1972 and Section 5504 of the Rehabilitation Act of 1973, and the Americans with Disabilities Act, has been delegated to Jane D. Rowlett, Ph.D., Director, Unclassified Affairs and University Compliance, 214 Anderson Hall, Kansas State University, Manhattan, KS 66506-0124 (913/532-4392). 2M