



DAIRY RESEARCH 2013

REPORT OF PROGRESS 1093



DAIRY RESEARCH 2013

Contents

- II Foreword
- IV Biological Variability and Chances of Error

Nutrition and Feeding

- 1 Effects of Chromium Propionate and Supplemental Amino Acids on Dairy Cattle Performance Near Peak Lactation

Reproduction

- 8 Concentrations of Luteinizing Hormone and Ovulatory Responses in Dairy Cows Before Timed Artificial Insemination
- 16 Five-day Resynch Programs in Dairy Cows Including Controlled Internal Drug Release at Two Stages Post-Artificial Insemination
- 22 Automated Activity Monitoring of Estrus and Time of Ovulation

Dairy Foods

- 27 Consumer Acceptance of Cysteine-Enhanced Yogurt

34 Acknowledgments

35 The Livestock and Meat Industry Council, Inc.

DAIRY RESEARCH 2013

Foreword

Members of the Dairy at Kansas State University are pleased to present the 2013 Dairy Research Report of Progress. Dairying continues to contribute significantly to the agricultural economy of Kansas. In 2010, dairy farms accounted for 3.9%, or \$542 million, of all Kansas farm receipts, ranking 7th overall among all Kansas farm commodities. At the end of 2011, Kansas ranked 12th nationally in milk yield per cow at 21,675 lb, 17th in the number of dairy cows (126,000), and 16th in total milk production (2.73 billion lb). During the past 5 years (2007 to 2012), total milk production in Kansas has increased by 24.9%; number of cows by 14.5%; and pounds of milk per cow by 1,793. Kansas now has 340 dairy operations and averages 371 cows per herd (*Hoard's Dairyman*, March 25, 2013, pp. 206–207).

Selected production traits of our Kansas State University Dairy Teaching and Research Center herd are shown below. On our October 2013 DHI test day, our cows averaged 94.9 lb in a facility that was built and populated in 1977. The excellent functioning of our herd is a tribute to the dedication of our staff: Michael Scheffel (manager), Daniel Umsheid, Robert Feist, Alan Hubbard, Kris Frey, and Eulises Jiron Corrales. Special thanks are given to Colleen Hill, Cheryl Armendariz, and a host of graduate and undergraduate students for their technical assistance in our laboratories and at the DTRC. We also acknowledge the support and cooperation of the Heart of America DHIA laboratory here in Manhattan, KS, for its assistance in handling research milk samples.

Kansas State University Dairy Teaching and Research Center Cows

Item	Units ¹
Cows, no.	270
Rolling herd milk, lb	30,745
Rolling herd fat, lb	1,075
Rolling herd protein, lb	931
Somatic cell count × 1,000	125
Calving interval, mo.	13.1

¹ October 21, 2013, test day (milking 3 times daily; no BST).

Most of this success occurs because dairy producers better manage what is measured in monthly DHI records. Continued emphasis should be placed on furthering the DHI program and encouraging use of its records in making management decisions. In addition, continued use of superior, proven sires and emphasis on use of superior genetics in artificial insemination programs is essential.

Thorough, quality research is not only time-intensive and meticulous, but also expensive. Each dollar spent for research yields a 30 to 50% return in practical application. Those interested in

supporting dairy research are encouraged to consider participation in the Livestock and Meat Industry Council (LMIC), a philanthropic organization dedicated to furthering academic and research pursuits by the Department of Animal Sciences and Industry. Additional details about the LMIC are found at the end of this report.

J. S. Stevenson, Editor
2013 Dairy Research Report of Progress

Biological Variability and Chances of Error

Variability among individual animals in an experiment leads to problems in interpreting the results. Although cows on treatment X may have produced more milk than those on treatment Y, variability within treatments may indicate that the differences in production between X and Y were not the direct result of treatment alone. Statistical analysis allows us to calculate the probability that such differences occur because of the treatment applied rather than from chance.

In some of the articles herein, you will see the notation " $P < 0.05$." That means the probability of treatment differences resulting from chance is less than 5%. If two averages are reported to be "significantly different," the probability is less than 5% that the difference is from chance, or the probability exceeds 95% that the difference resulted from the treatment applied.

Some papers report correlations or measures of the relationship among traits. The relationship may be positive (both traits tend to get larger or smaller together) or negative (as one trait gets larger, the other gets smaller). A perfect correlation is one (+1 or -1). If there is no relationship, the correlation is zero.

In other papers, you may see an average given as 2.5 ± 0.1 . The 2.5 is the average; 0.1 is the "standard error." The standard error is calculated to be 68% certain that the real average (with an unlimited number of animals) would fall within one standard error from the average, in this case between 2.4 and 2.6.

Using many animals per treatment, replicating treatments several times, and using uniform animals increase the probability of finding real differences when they exist. Statistical analysis allows more valid interpretation of the results, regardless of the number of animals in the experiment. In all the research reported herein, statistical analyses are included to increase the confidence you can place in the results.

Effects of Chromium Propionate and Supplemental Amino Acids on Dairy Cattle Performance Near Peak Lactation

F. Vargas, K. Yuan, E. Titgemeyer, L. Mamedova, and B. J. Bradford

Summary

Feeding chromium in early lactation can increase milk production, but responses during peak lactation have not been studied. The objective of this study was to evaluate responses to chromium propionate during this period as well as interactions with rumen-protected lysine and methionine. Chromium propionate increased feed intake and tended to increase energy-corrected milk yield, and primiparous cows showed greater responses in feed intake and milk protein yield than multiparous cows. In this study, feeding chromium propionate near peak lactation increased feed intake and tended to increase productivity, but no benefits of supplementing rumen-protected lysine and methionine were observed.

Key words: chromium, amino acids, lactation

Introduction

After parturition, cows must adapt to milk secretion, but their daily dry matter intake rarely matches the nutrient demands for that activity. Because of these extremely high nutrient requirements, cows near peak lactation are the most likely to experience amino acid deficiencies, which can limit peak milk and, in turn, decrease whole-lactation productivity.

It is known that dietary chromium (Cr) can enhance carbohydrate metabolism and affect protein synthesis, which can contribute to improved metabolic function after calving. In fact, previous studies have reported increases in milk production when supplemental Cr was utilized in diets during the first 3 weeks of lactation. Some producers have now begun feeding supplemental Cr later in lactation, but no controlled studies have evaluated whether Cr is beneficial at this stage of lactation. Furthermore, no information is available about interactions between amino acid nutrition and Cr supplementation in dairy cattle. Therefore, further investigation is necessary into responses to Cr near peak lactation, both in the presence and absence of supplemental AA.

Experimental Procedures

Forty-eight lactating Holstein cows (21 primiparous and 27 multiparous, 38 ± 15 DIM) were used in a randomized complete block design with 4 treatments. The cows were stratified by calving date into 12 blocks and assigned randomly to treatments within block. All cows were housed in tie-stalls and individually fed a common diet (Table 1). Analysis by the Cornell Net Carbohydrate and Protein System version 6.1 (NDS version 3, Ruminant Management & Nutrition, Reggio Emilia, Italy) estimated metabolizable methionine supply at 47 g/day (2.03% of metabolizable protein) and metabolizable lysine supply at 148 g/day (6.38% of metabolizable protein) at a DMI of 22 kg/day. Treatments were premixed with ground corn and offered as a top-dress at a rate of 200 g/cow daily for 35 days. Treatments were control, Cr propionate (CrPr; 8 mg/day Cr in the form of 20 g/day KemTRACE Chromium Propionate 0.04%, Kemmin Industries, Des Moines, IA), rumen-protected lysine and methionine (RPLM;

10 g/day lysine and 5 g/day methionine, intestinally available), or both (**CrPr+RPLM**). The RPLM supplement was composed of 48.8 g/day of LysiPEARL and 15.3 g/day of MetiPEARL (Kemin Industries). Cows were milked 3 times daily (3:00 a.m., 11:00 a.m., and 7:00 p.m.) and fed once daily (4:00 p.m.) for ad libitum intake, targeting 10% daily refusals.

Feed offered and feed refused were measured for each cow daily to determine DMI. Milk yield was recorded for each cow daily. Body weights and BCS were measured on days 1 and 35. Milk samples were collected 3 days per week and were analyzed for concentration of fat, true protein, lactose, MUN, and somatic cells. Samples of feed ingredients were collected weekly and frozen for analysis.

One cow on CrPr+RPLM developed severe mastitis on day 20 of treatment and was subsequently removed from the study. No data were collected or analyzed for this cow. Milk and DMI data were averaged by week prior to analysis. Data were analyzed using the MIXED procedure of SAS to assess the fixed effects of parity (primiparous vs. multiparous); time; CrPr; RPLM; 2-, 3-, and 4-way interactions; and the random effect of block. Significance was declared at $P \leq 0.05$ and tendencies at $0.05 < P < 0.10$.

Results and Discussion

Dry matter intake was significantly increased by CrPr ($P < 0.05$) but was not significantly affected by RPLM when fed for 5 weeks near peak lactation (Table 2). Although neither RPLM nor CrPr significantly altered yields of milk or milk components, CrPr tended to increase ECM ($P = 0.09$) by 6% (Table 2). In addition, there was evidence of parity \times CrPr interactions for both DMI ($P = 0.06$) and milk protein yield ($P = 0.04$), in both cases indicating positive responses to CrPr in primiparous cows but not in multiparous cows (Figure 1). Feed efficiency was unaffected, because the increases in milk yield and DMI in response to Cr supplementation paralleled each other.

The interaction of RPLM and CrPr affected milk protein content ($P = 0.04$, Table 2). Somewhat counterintuitively, in the absence of CrPr, RPLM decreased milk protein content ($P < 0.01$), but no effect of RPLM was detected in the presence of CrPr ($P = 0.77$). Rumen-protected lysine and methionine also decreased the efficiency of N utilization for milk protein ($P = 0.05$). There was a CrPr \times week interaction ($P = 0.04$) for lactose content, reflecting significantly greater lactose content (4.99 vs. $4.86 \pm 0.036\%$) in response to CrPr during week 1. What caused this response or why it was transient is unclear. No treatment effects were detected for BW change or BCS change (Table 2). The negative values for BW and BCS changes suggested that cows were in a catabolic state.

Plasma amino acid profiles are presented in Table 3. The proportion of lysine significantly increased ($P = 0.05$) and that of methionine tended to increase ($P = 0.07$) in response to RPLM, as was expected when these amino acids were supplemented. On the other hand, the proportion of threonine was significantly decreased by RPLM ($P < 0.01$). A tendency for a CrPr \times RPLM interaction ($P = 0.06$) was observed for tryptophan, reflecting a decreased proportion of tryptophan by CrPr in the presence of RPLM ($P = 0.03$), but not in the absence of RPLM ($P = 0.64$). The plasma lysine and methionine responses to RPLM were less than might have been expected, given the lack of increased milk protein yield. We observed approximately a 10% increase in lysine and 6% increase in methionine as a proportion of AA in response to estimated

supplementation of 10 and 5 g/day, respectively, in contrast to previous findings demonstrating 30% increases or greater with similar supplementation rates.

Conclusions

The supplementation of CrPr increased DMI and tended to increase ECM yield of peak-lactation cows when fed for a 5-wk period, and DMI as well as milk protein yield was particularly enhanced in primiparous cows. The inclusion of RPLM increased lysine and tended to increase methionine as a proportion of plasma AA but decreased the efficiency of N utilization for milk protein. These findings indicate that responses to dietary Cr in the dairy cow are not limited to early lactation, but fail to demonstrate any increased responsiveness to supplemental essential amino acids when CrPr is fed.

Table 1. Ingredient and nutritional composition of the basal diet

Ingredient	% of DM
Corn silage	31.5
Alfalfa hay	23.4
Wet corn gluten feed ¹	6.8
Ground corn	23.1
Whole cottonseed	4.6
Expeller soybean meal	2.1
Solvent extracted soybean meal	5.1
Calcium salts of fatty acids ²	0.8
Micronutrient premix	2.6
Nutrient	
DM, % as-fed	57.9
OM	91.3
CP	16.7
NDF	31.7
ADF	20.1
Forage NDF	22.1
NFC	39.8
Ether extract	3.1
Model-predicted ME ³ Mcal/kg	2.50

¹Sweet Bran, Cargill Corn Milling, Blair, NE.

²Megalac R, Arm & Hammer Animal Nutrition, Princeton, NJ.

³Metabolizable energy predicted by CNCPS 6.1 (NDS version 3, Ruminant Management & Nutrition, Reggio Emilia, Italy).

Table 2. Chromium propionate (CrPr) and rumen-protected lysine and methionine (RPLM) effects on intake, productivity, and milk composition of lactating dairy cows

Item	Control		RPLM		SEM	P-value		
	Control	CrPr	Control	CrPr		CrPr	RPLM	Interaction
DMI ¹ , kg/d	19.89	22.20	21.73	22.28	1.10	< 0.05	0.18	0.23
Milk yield, kg/d	40.53	43.72	42.42	43.25	1.44	0.14	0.61	0.39
Milk fat, %	4.20	4.13	3.95	3.97	0.15	0.88	0.19	0.74
Milk protein, %	2.75	2.67	2.62	2.68	0.04	0.66	0.09	0.04
Milk lactose, %	4.90	4.99	4.89	4.90	0.04	0.26	0.24	0.37
MUN ² , mg/dL	13.21	14.01	13.78	13.10	0.56	0.89	0.70	0.09
SCC ³ linear score	1.59	1.10	1.58	1.65	0.50	0.66	0.56	0.56
Fat yield, kg/d	1.68	1.81	1.66	1.70	0.07	0.27	0.37	0.58
Protein yield, kg/d	1.12	1.16	1.12	1.17	0.03	0.22	0.93	0.86
Lactose yield, kg/d	2.01	2.17	2.09	2.15	0.07	0.15	0.74	0.54
Body weight change, kg/29 d	-14.6	-9.9	-13.7	-7.6	4.15	0.21	0.74	0.89
BCS ⁴ change	-0.31	-0.32	-0.33	-0.27	0.09	0.06	0.86	0.32
ECM ⁵ , kg/d	43.14	46.30	43.09	44.91	1.47	0.09	0.62	0.65
ECM/DMI	2.18	2.08	2.02	2.02	0.08	0.53	0.16	0.56

¹Dry matter intake.²Milk urea nitrogen.³Somatic cell count.⁴Body condition score.⁵Energy-corrected milk = (0.327 × milk yield) + (12.95 × fat yield) + (7.65 × protein yield); (Dairy Record Management Systems, 2013).

Table 3. Chromium propionate (CrPr) and rumen-protected lysine and methionine (RPLM) effects on plasma amino acids on lactating dairy cows

Amino acid (molar % of total AA)	Control		RPLM		SEM	<i>P</i> -value		
	Control	CrPr	Control	CrPr		CrPr	RPLM	Interaction
Glycine	15.57	15.07	14.98	13.92	1.10	0.48	0.42	0.80
Valine	12.19	12.19	11.90	11.07	0.65	0.47	0.28	0.53
Alanine	10.88	11.84	11.72	11.53	0.43	0.37	0.52	0.18
Glutamine	8.70	7.97	8.95	9.44	0.58	0.81	0.09	0.22
Leucine	8.20	8.08	8.11	7.89	0.45	0.66	0.71	0.91
Isoleucine	6.82	6.63	6.77	6.71	0.40	0.72	0.96	0.86
Threonine	4.52	4.72	4.17	3.97	0.24	0.99	0.02	0.25
Citrulline	4.40	4.65	4.08	4.18	0.34	0.32	0.23	0.81
Serine	3.95	3.96	3.99	3.81	0.17	0.58	0.73	0.55
Arginine	3.61	4.07	4.01	3.94	0.21	0.30	0.45	0.16
Lysine	3.34	3.37	3.80	3.59	0.17	0.55	0.05	0.47
Glutamate	3.02	2.91	2.78	2.85	0.28	0.91	0.47	0.67
Tyrosine	2.14	2.15	2.30	2.23	0.10	0.75	0.22	0.65
Histidine	2.10	2.09	1.89	2.05	0.07	0.28	0.09	0.25
Asparagine	2.06	1.85	2.20	2.22	0.24	0.63	0.18	0.55
Phenylalanine	1.97	1.96	2.13	2.03	0.08	0.43	0.11	0.52
Taurine	1.75	1.90	1.58	1.80	0.17	0.27	0.41	0.83
Ornithine	1.73	1.68	1.77	1.73	0.10	0.56	0.64	0.97
Tryptophan	1.63	1.68	1.73	1.53	0.07	0.18	0.69	0.06
Methionine	0.95	0.99	1.06	1.01	0.04	0.93	0.07	0.12
Aspartate	0.32	0.38	0.33	0.34	0.02	0.13	0.51	0.28
Total amino acids, mM	2.47	2.39	2.14	2.39	0.10	0.39	0.11	0.11

NUTRITION AND FEEDING

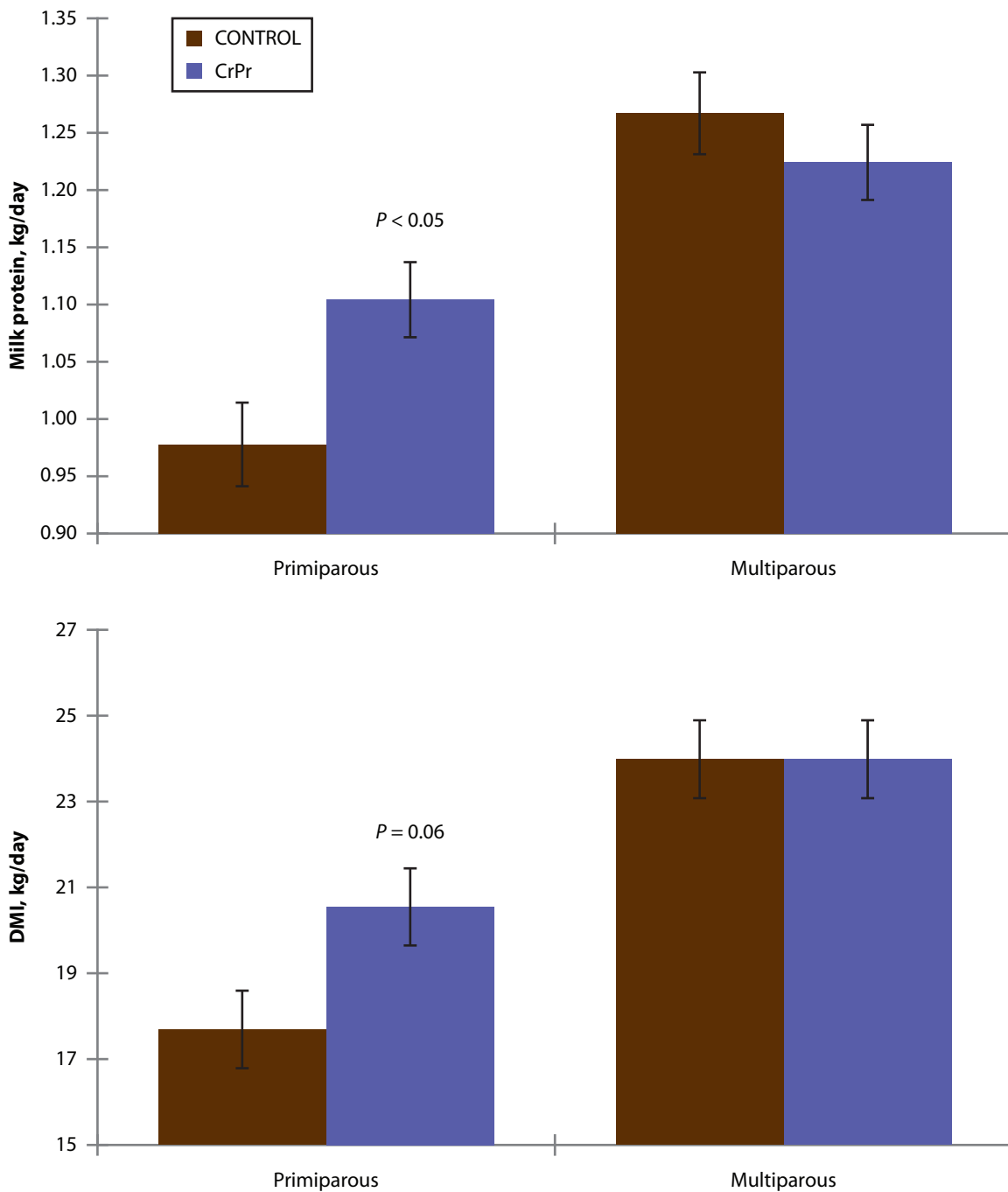

Figure 1. Interactions of chromium propionate (CrPr) and parity for milk protein yield (A) and dry matter intake (DMI; B). Supplements were fed for 35 days near peak lactation, and DMI and milk production responses were analyzed by week throughout the study. Values are LSM \pm SEM, n = 10 to 13.

Concentrations of Luteinizing Hormone and Ovulatory Responses in Dairy Cows Before Timed Artificial Insemination

S. L. Pulley, D. H. Keisler, S. L. Hill, and J. S. Stevenson

Summary

The objective of this study was to determine the incidence of spontaneous and gonadotropin-releasing hormone (GnRH)-induced surges of luteinizing hormone (LH) and ovulatory responses in lactating dairy cows enrolled in a timed artificial insemination (TAI) protocol. Cows ($n = 70$) in a single herd were assigned to one of two presynchronization protocols: Pre-10 or PG-3-G. Cows assigned to the Pre-10 treatment received 2 injections of prostaglandin $F_{2\alpha}$ (PGF $_{2\alpha}$) 14 days apart (Presynch), with the second injection administered 10 days before the onset of a TAI protocol. Cows assigned to the PG-3-G treatment received an injection of prostaglandin $F_{2\alpha}$ (PGF $_{2\alpha}$), then 3 days later an injection of GnRH (GnRH-1) 7 days before the onset of a TAI protocol. All cows received the first GnRH injection (GnRH-2) of the Ovsynch protocol and a PGF $_{2\alpha}$ injection 7 days later, then cows received the breeding injection of GnRH (GnRH-3) at either 56 or 72 hours after PGF $_{2\alpha}$, with insemination occurring 12 to 16 hours after the second GnRH injection. Blood samples were collected during the study to monitor serum changes in LH, progesterone, and estradiol to determine why ovulatory responses to GnRH-induced LH release did not approach 100% when follicle dominance and adequate follicle size was achieved. Presynchronization administration of GnRH-1 increased the incidence of LH surges and ovulation rates in cows presynchronized with PG-3-G compared with Pre-10. Incidence of ovulation and occurrence of LH surges did not differ after GnRH-2, but more LH was released in Pre-10 than PG-3-G cows. Luteolysis, LH surge incidence, and ovulation rates were similar among the 4 treatment-time combinations after GnRH-3. Pregnancy per TAI was decreased in Pre-10 at 56 hours compared with Pre-10 at 72 hours and PG-3-G at 56 and 72 hours. We concluded that administration of GnRH 56 hours before breeding decreased pregnancy per TAI compared with administration of GnRH at 72 hours when cows were presynchronized with Pre-10. Presynchronization with PG-3-G resulted in acceptable pregnancy per TAI with GnRH administration occurring at either 56 or 72 hours before TAI. The flexibility of GnRH timing with the PG-3-G presynchronization protocol may be an advantage compared with the Pre-10 protocol for dairy cattle when programmed for a TAI at first service.

Key words: follicle, Ovsynch, presynchronization, timed AI

Introduction

Timed artificial insemination (TAI) protocols provide viable alternatives to heat detection by enabling control of estrous cycles (through promoting follicular dominance, maintaining adequate follicle size, and enforcing luteolysis). The most commonly used TAI protocol in the United States dairy industry is Ovsynch.

Presynchronization before initiation of the Ovsynch protocol generally improves pregnancy per TAI (P/TAI) compared with Ovsynch alone. The standard presynchronization protocol includes 2 PGF $_{2\alpha}$ injections given 14 days apart, with the Ovsynch protocol beginning 10 to 14 days after the second PGF $_{2\alpha}$ injection. The interval between Presynch and Ovsynch has been

studied with 10 (Presynch-10), 11 (Presynch-11), 12 (Presynch-12), or 14 days (Presynch-14) between the second PGF_{2α} injection and the onset of Ovsynch. Presynch programs with intervals of 10 or 11 days have improved P/TAI compared with programs with 14 days. This increase is a consequence of an improved ovulation response to the initial gonadotropin-releasing hormone (**GnRH**) injection of Ovsynch. Other presynchronization programs involve the use of a non-breeding Ovsynch protocol (**Double-Ovsynch**), or a combination of PGF_{2α} and GnRH injections given 2 (**G-6-G**) or 3 days (**PG-3-G**) apart followed in 6 or 7 days, respectively, by enrollment in Ovsynch.

Double-Ovsynch improved P/TAI in primiparous, but not in multiparous cows compared with Presynch-12. In a recent study (Dairy Research 2012, pp. 15–21), we demonstrated that PG-3-G program increased P/TAI compared with Presynch-10 during summer and proposed that PG-3-G is a more effective presynchronization program because of its ability to induce ovulation in anovular cows and increase the number of cows with a corpus luteum and greater progesterone concentration at the onset of Ovsynch. Previous reports have stated that greater ovulatory response to the first GnRH injection of the Ovsynch protocol results in improved embryo quality and greater P/TAI. Ovulation responses to the initial GnRH injection reportedly are 67 to 79%; however, responses to the second GnRH injection are generally greater and range from 96 to 97%.

Our main research question was why ovulatory responses to both GnRH injections do not approach 100%. Administration of GnRH stimulates the release of a surge of luteinizing hormone (**LH**) and follicle-stimulating hormone (**FSH**) into circulation, which results in the ovulation of dominant follicles in 24 to 32 hours. Cows treated with GnRH during the luteal phase release less LH than cows treated during the follicular phase. Another study reported that cows with lesser progesterone concentrations had greater LH release following GnRH treatment. Although TAI programs based on the Ovsynch protocol are extensively used in the field and in research settings, relatively little is known about the characteristics of LH secretion in association with PGF_{2α}-induced luteolysis and GnRH injections during these programs. The objective of this study was to determine the incidence of spontaneous and GnRH-induced surges of LH and ovulatory responses in lactating dairy cows enrolled in a TAI protocol.

Experimental Procedures

Lactating Holstein cows (n = 70) from the Kansas State University Dairy Teaching and Research Center were enrolled in the study. Cows were milked thrice daily and were housed in tie stalls and fed twice daily a TMR calculated to meet or exceed the nutrient requirements for a lactating Holstein cow producing 50 kg of 3.5% milk. The diet consisted of corn silage, sweet bran, cracked corn, alfalfa hay, whole cottonseed, soybean meal, vitamins, and minerals. Breeding clusters (n = 12) were formed every 14 days as cows and heifers calved. Cows were blocked by lactation number and DIM, and blocks were assigned randomly to 2 presynchronization treatments (Figure 1). The two treatments were: (1) Pre-10 (n = 37): two 25-mg injections of PGF_{2α} (PG-1 and PG-2) 14 days apart (Presynch); or (2) PG-3-G (n = 33): one 25-mg injection of PG 3 days before 100 µg GnRH (GnRH-1), with the PG injection administered at the same time as PG-2. Cows were enrolled in a TAI protocol 10 days after PG-2 (Ovsynch; injection of GnRH 7 days before [GnRH-2] and 56 or 72 hours after [GnRH-3] PG-3, with AI at 72 hours after PG-3). Inseminations occurred October 2011 through March 2012.

Body condition scores (BCS; 1 = thin and 5 = fat) were assigned on day -7 for each cow. Blood was sampled from all cows by puncture of the coccygeal vein or artery into evacuated tubes (BD Vacutainer, Franklin Lakes, NJ) or by indwelling jugular catheters. Blood was collected (Figure 1) to determine LH at: (1) GnRH-1: 0 to 80 hours after PG-2 and hourly from 72 to 78 hours (GnRH-1 at 72 hours); (2) GnRH-2: 0 to 6 hours after GnRH-2; and (3) GnRH-3: 0 to 80 hours after PG-3 and hourly from 56 to 62 or 72 to 78 hours for cows injected with GnRH at 56 or 72 hours after PG-3. Additional blood samples were collected every 12 hours after PG-3 from 0 to 72 hours for estradiol assay. Samples were immediately cooled and stored at 5°C for 16 hours. Blood tubes were centrifuged at 1,000 x g for 15 minutes in a refrigerated centrifuge at 5°C for serum separation and harvest. Serum samples were frozen and stored at -20°C until assayed for LH, progesterone, and estradiol by radioimmunoassay.

Ovaries of all cows were examined via transrectal ultrasonography using an Aloka 500V ultrasound scanner equipped with 5.0 MHz linear probe to determine the structures present in each ovary at PG-2, PG-3, GnRH-1, 2, and 3. A structural map of each ovary was drawn with the position and diameter of follicles ≥ 5 mm in diameter and each corpus luteum (CL), which allowed for evaluation of visual luteolysis and ovulatory response to each GnRH injection. Follicle diameter was determined by averaging the perpendicular measurements of follicular width and height using the internal calipers of the Aloka 500V. Ovulation was defined as disappearance of one or more follicles greater than ≥ 8 mm in diameter from an ovary, when a follicle had been recorded on the previous scan of that ovary, followed by the formation of a CL.

Pregnancy was initially diagnosed at 31 days post-TAI by ultrasonography. Pregnancy was re-confirmed at 61 days by transrectal ultrasonography. Pregnancy loss was calculated between the 2 pregnancy diagnoses.

Results and Discussion

Cows presynchronized with PG-3-G had 3 times more induced LH surges than Pre-10 cows (Table 1) and a similar greater ovulation response to GnRH-1 than Pre-10 cows, respectively. The proportion of cows with spontaneous or no LH surge was greater in Pre-10 than PG-3-G cows, respectively (Figure 2). These results are similar to those we had previously reported, in which PG-3-G resulted in increased ovulation incidence compared with spontaneous ovulation in the Pre-10 treatment (80 vs. 53%), respectively. In addition, progesterone concentrations before the GnRH-1 injection did not differ between Pre-10 and PG-3-G cows (0.7 ± 0.4 vs. 0.5 ± 0.3 ng/mL) in either the current or the previous study.

Serum LH concentrations were greater ($P < 0.01$) for cows receiving Pre-10 than PG-3-G during 1 to 3 hours post-GnRH-2 (Figure 3). An induced LH surge occurred in all cows at GnRH-2 (Table 2) regardless of treatment. Concentrations of LH were greater ($P < 0.05$) at 1, 2, and 3 hours after GnRH-2, but incidence of ovulation did not differ between treatments. Less LH release in the PG-3-G cows likely occurred because serum progesterone concentrations tended ($P = 0.069$) to be greater in PG-3-G than Pre-10 cows before GnRH-2 injection (4.1 ± 0.6 vs. 2.7 ± 0.5 ng/mL). This agrees with our previous study in which progesterone was greater in PG-3-G than Pre-10 cows, but ovulation incidences did not differ.

Serum LH concentrations were similar for cows regardless of presynchronization treatment (Figure 4) or timing of the GnRH-3 (Figure 5). More ($P < 0.05$) cows had induced LH surges after GnRH-3 at 56 hours than after 72 hours (Table 3). No difference was detected in pro-

gesterone or estradiol concentrations between treatments during the sampling period for GnRH-3. At GnRH-3, ovulation was similar for Pre-10 and PG-3-G cows, regardless of time of GnRH-3 administration at 56 or 72 hours.

Pregnancy per TAI for the main effects of treatment (PG-3-G vs. Pre-10) and time of GnRH-3 (56 vs. 72 hours) did not differ, but the Pre-10, 72-hour treatment combination was less ($P < 0.01$) than all other treatment combinations (Table 4).

We concluded that more PG-3-G cows had LH surges and a greater ovulation incidence at GnRH-1 compared with Pre-10. Consistent with our earlier report, cows presynchronized with the PG-3-G program had increased ovulation rates after GnRH-1 and greater ($P = 0.069$) progesterone before GnRH-2 than Pre-10 cows.

Table 1. Luteolysis, incidence of luteinizing hormone (LH) surges, and ovulation after PG-1 or PG-2 and GnRH-1

Item	Treatment	
	Pre-10	PG-3-G
Luteolysis ¹ ,%	56.8 (21/37)	60.6 (20/33)
LH surge ² ,%	33.3 ^a (12/36)	100 ^b (33/33)
Ovulation ³ ,%	33.3 ^a (12/36)	100 ^b (33/33)

^{a,b} Means differ ($P = 0.002$) between treatments.

¹ Luteolysis was determined by changes in progesterone concentration between PG-2 (≥ 1 ng/mL) and 72 hours later (< 1 ng/mL).

² Increase in LH concentration greater than 2 SD above baseline.

³ Spontaneous ovulation or ovulation response to GnRH-1.

Table 2. Incidence of luteinizing hormone (LH) surges and ovulation after GnRH-2

Item	Treatment	
	Pre-10	PG-3-G
LH surge ¹ ,%	81.1 (30/37)	90.9 (30/33)
Ovulation ² ,%	62.2 (23/37)	51.5 (17/33)
Double ovulation ³ ,%	18.9 (7/37)	6.1 (2/33)

¹ Increase in LH concentration greater than 2 SD above baseline.

² Ovulation of one follicle after GnRH-2.

³ Ovulation of more than one follicle after GnRH-2.

Table 3. Luteolysis, incidence of luteinizing hormone (LH) surges, and ovulation after GnRH-3

Item	Treatment ¹			
	Pre-10		PG-3-G	
	56 hours	72 hours	56 hours	72 hours
Luteolysis ¹ , %	86.5 (32/37)		90.9 (30/33)	
LH surge ² , %				
Induced	100 (19/19)	83.8 (15/18)	100 (14/14)	94.1 (16/17)
Spontaneous	0 (0/19)	16.7 (3/18)	0 (0/14)	0 (0/17)
Ovulation ³ , %	100 (19/19)	88.9 (16/18)	87.5 (14/16)	93.3 (14/17)
Double ovulation ⁴ , %	5.3 (1/19)	11.1 (2/18)	6.2 (1/16)	5.9 (1/17)

¹Luteolysis was determined by changes in progesterone concentration between PG-2 (≥ 1 ng/mL) and 72 h later (< 1 ng/mL).

²Increase in LH concentration greater than 2 SD above baseline.

³Ovulation of one follicle after GnRH-2.

⁴Ovulation of more than one follicle after GnRH-2.

Table 4. Pregnancy per AI after presynchronization with Pre-10 or PG-3-G and GnRH administration at 56 or 72 hours

Item	Treatment ¹			
	Pre-10		PG-3-G	
	56 hours	72 hours	56 hours	72 hours
Pregnancy per AI ² , %				
At 31 d	52.6 ^a (10/19)	22.2 ^b (4/18)	57.1 ^a (8/14)	56.3 ^a (9/16)
At 61 d	52.6 ^a (10/19)	22.2 ^b (4/18)	57.1 ^a (8/14)	53.3 ^a (8/15)
Pregnancy loss ³ , %	0 (0/19)	0 (0/18)	0 (0/14)	6.3 (1/16)

^{a,b} Means differ ($P < 0.002$) within row.

¹ See Figure 1.

² Determined by transrectal ultrasonography of uterine fluid and presence of viable embryo.

³ Pregnancy losses were calculated between the two pregnancy diagnoses.

REPRODUCTION

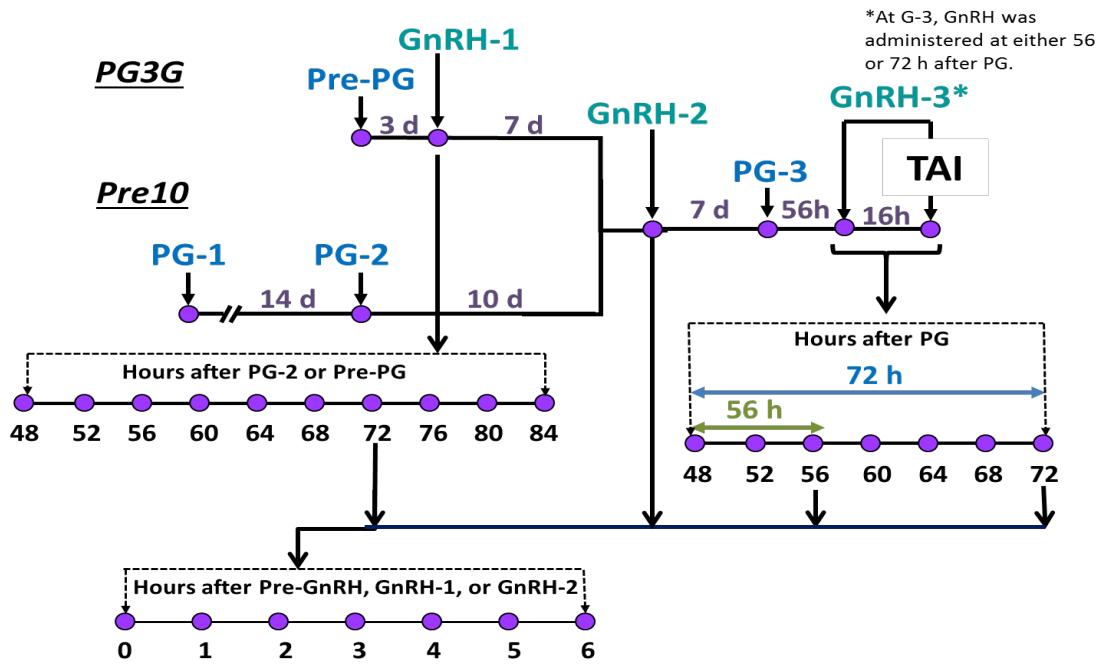

Figure 1. Experimental protocol for blood collection (PG = PGF_{2a}, TAI = timed artificial insemination, GnRH = gonadotropin-releasing hormone).

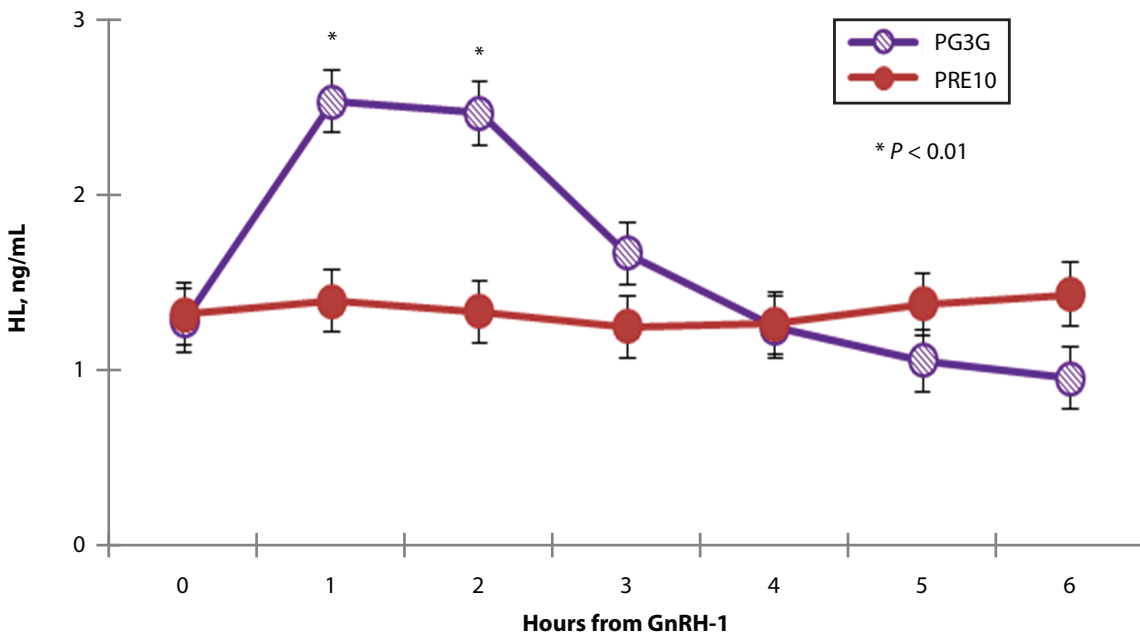

Figure 2. Pattern of serum luteinizing hormone (LH) concentrations during a period of 6 hours after GnRH-1.

REPRODUCTION

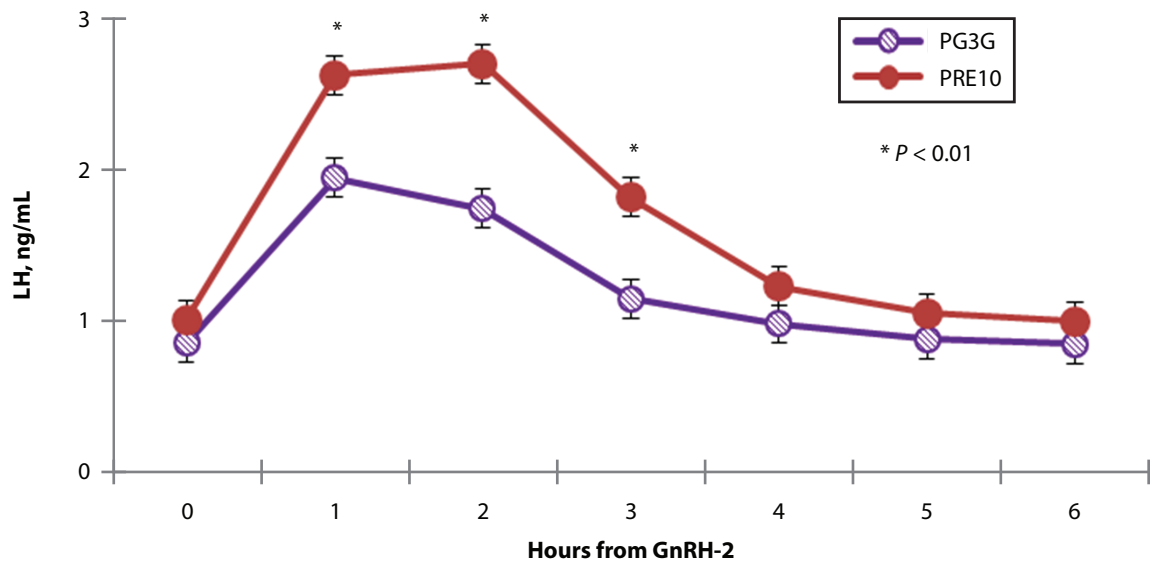

Figure 3. Pattern of serum luteinizing hormone (LH) concentrations during a period of 6 hours after GnRH-2.

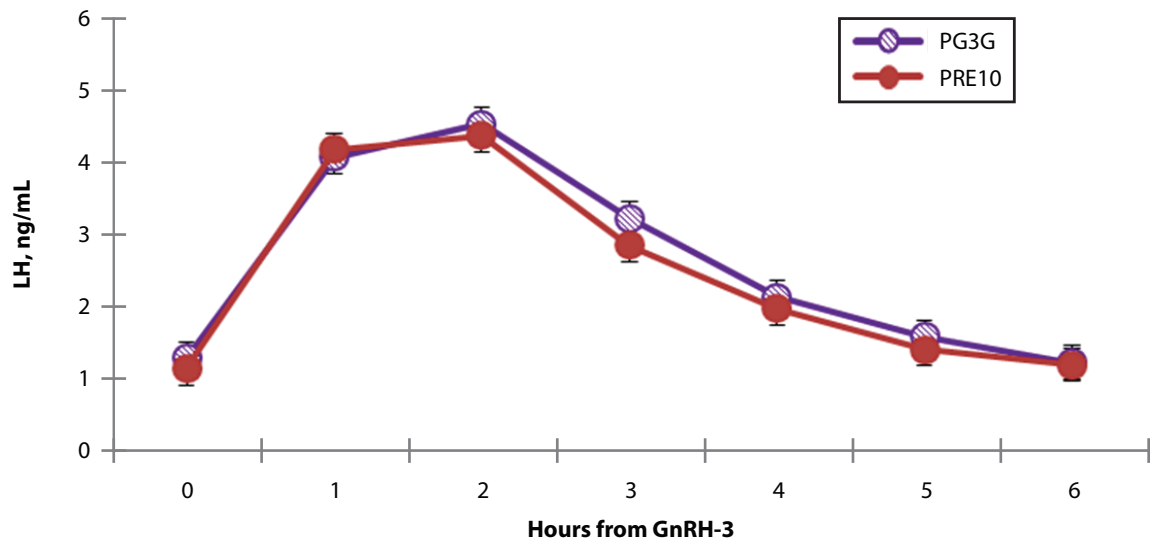

Figure 4. Pattern of serum luteinizing hormone (LH) concentrations during a period of 6 hours after GnRH-3.

REPRODUCTION

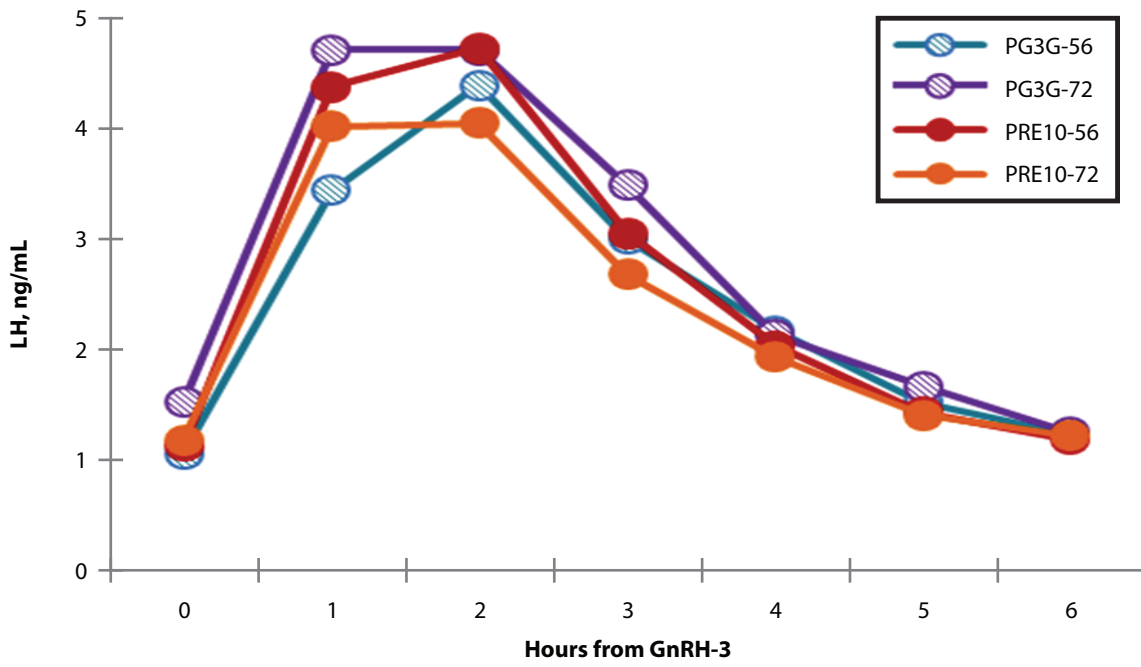

Figure 5. Pattern of serum luteinizing hormone (LH) concentrations during a period of 6 hours after GnRH-3 according to presynchronization treatment and timing of GnRH administration.

Five-day Resynch Programs in Dairy Cows Including Controlled Internal Drug Release at Two Stages Post-Artificial Insemination

S. L. Pulley, S. L. Hill, and J. S. Stevenson

Summary

Two experiments were conducted to assess pregnancy outcomes after a 5-day Ovsynch-56 Resynch (**RES**; gonadotropin-releasing hormone injection 5 days before [**GnRH-1**; d 0] and 56 hours (**GnRH-2**) after PGF_{2α} [**PG**] injections on day 5 and 6, timed artificial insemination [**TAI**] on day 8) with and without a progesterone-releasing intravaginal controlled internal drug release (**CIDR**) 5-day insert. In Exp. 1, nonpregnant cows were enrolled on day 34 post-AI: day 34 **RES-CON** (n = 528) or day 34 **RES-CIDR** (n = 503). Blood was collected for progesterone assay. Pregnancy per AI (**P/AI**) was diagnosed by uterine palpation per rectum at 34 and 62 days post-TAI. Only 76% of 1,031 cows had high progesterone (≥ 1 ng/mL) on day 34 at the nonpregnant diagnosis. No differences in P/AI were detected between treatments. The day-34 **RES-CIDR** cows with low (< 1 ng/mL) progesterone, however, had greater ($P = 0.036$) P/AI than day-34 **RES-CON** cows (37.7 vs. 29.4%), whereas day-34 **RES-CIDR** cows with high progesterone had lesser P/AI than day-34 **RES-CON** (27.4 vs. 34.3%). In Exp. 2, cows were enrolled on day 31 post-AI after a nonpregnant diagnosis: (1) day 31 **PG-3-G** (n = 102): Pre-PG on day 31, Pre-GnRH on day 34, and RES on day 41 (n = 102); (2) day 41 **RES-CON** (n = 108) as Exp. 1, but on day 41; and (3) day 41 **RES-CIDR** (n = 101) as Exp. 2, but on day 41. Blood was collected for progesterone assay and ovarian structures were mapped by ultrasonography on days 31, 34, 41, 46, and 48. Pregnancy was diagnosed by ultrasonography on days 31 and 59 post-TAI. The proportion of cows with high progesterone on day 31 was 70.6%. More ($P < 0.001$) cows ovulated after Pre-GnRH on day 31 **PG-3-G** (60.4%) than for day 41 **RES-CON** (12.5%) or day 41 **RES-CIDR** (17.1%). More ($P < 0.001$) **PG-3-G** cows had luteolysis after Pre-PG on day 31 than other treatments (73.7 vs. $< 11\%$). The proportion of cows with high progesterone on day 41 at GnRH-1 tended ($P = 0.10$) to be greater for **PG-3-G** (75.6%) than for other treatments (65 to 70%). The P/AI was greater in cows starting RES on day 41 when progesterone was low (44%) than when it was high (33%), but no treatment differences were detected 31 days after TAI (**PG-3-G** = 33.3%; d 41 **RES-CON** = 38.9%; d 41 **RES-CIDR** = 35.6%). We concluded that improved P/AI for cows initiating the 5-day RES on day 34 without a corpus luteum is progesterone-dependent because addition of the **CIDR** insert to the RES treatment improved P/AI in cows with low progesterone (Exp. 1). Although day-31 **PG-3-G** increased luteolysis and produced greater ovulation rates before the onset of RES, no increase in P/AI was detected compared with RES started on day 41 with or without a **CIDR** insert.

Key words: CIDR, Resynch, pregnancy

Introduction

Lactating dairy cows generally have poorer pregnancy outcomes at second and subsequent services when timed artificial insemination (**TAI**) programs are applied. Currently, many well-managed dairies are achieving TAI pregnancies in the 40% range at first service after calving. Pregnancy outcomes for TAI repeat services are in the 30 to 35% range for the most part.

Poorer pregnancy outcomes of repeat or Resynch (**RES**) inseminations seem to be associated with poorer ovulatory responses to gonadotropin-releasing hormone (**GnRH**) and failure of the corpus luteum to regress in response to PGF_{2 α} (**PG**). Studies in which open cows are pretreated with GnRH or human chorionic gonadotropin (hCG) 7 days before RES have improved pregnancy outcomes, but they also extend the inter-insemination interval for individual cows because of the delay between open diagnosis and re-insemination. Injecting PG 7 or 11 days before RES also delays reinsemination, but when coupled with detection of estrus, more cows are reinseminated before the follow-up RES is applied to those cows not inseminated.

Our objective was to determine the value of applying progesterone in the form of a CIDR insert to cows diagnosed open at day 34 after last insemination (Exp. 1). A second experiment was performed with the same objective. The RES program with or without the CIDR insert, however, was applied on day 41, and a third treatment included a presynchronization (PG + GnRH) treatment before RES. In both experiments, a 5-day RES-Ovsynch protocol was used.

Experimental Procedures

Lactating dairy cows from two herds in northeast Kansas were enrolled in the study. All cows were milked three times daily and fed diets consisting of alfalfa hay, corn silage, soybean meal, whole cottonseed, corn or milo grain, corn gluten feed, vitamins, and minerals.

The herd enrolled in Exp. 1 comprised cows ($n = 1,031$) diagnosed open 34 days (range of 34 to 40 days, with the majority of cows on day 34) post-AI by uterine palpation per rectum by a single veterinarian from September 2010 through October 2012. Non-pregnant cows were assigned randomly to a 5-d Ovsynch-56 Resynch (RES; GnRH injection 5 days before [GnRH-1; day 0] and 56 hours (GnRH-2) after PGF_{2 α} [PG] injections on days 5 and 6, TAI on day 8) with (day-34 **RES-CON**, $n = 528$) or without a progesterone-releasing intravaginal controlled internal drug release (CIDR) 5-day insert (day-34 **RES-CIDR**, $n = 503$, Figure 1).

The herd enrolled in Exp. 2 comprised cows ($n = 209$) diagnosed open 31 days (range of 30 to 36 days, with the majority of cows on day 31) post-AI by transrectal ultrasonography from November 2010 through October 2012. Non-pregnant cows were assigned randomly to either day-31 **PG-3-G** (Pre-PG on day 31, Pre-GnRH on day 34, and RES on day 41; $n = 102$), day-41 **RES-CON** (same as in Exp. 1, but on day 41; $n = 108$) or day-41 **RES-CIDR** (as Exp. 2 but on day 41, $n = 101$, Figure 2). Ovarian structures were recorded and mapped by ultrasonography on days 31, 41, 46, and 48 to determine the incidence of luteolysis, ovulation, and double ovulation in all cows. Cows returning to estrus before TAI were inseminated and designated as early bred (**EB**).

Pregnancy per AI (**P/AI**) was diagnosed at 34 days and confirmed at 62 days post-TAI by uterine palpation per rectum by a single veterinarian (Exp. 1) or at 31 days and confirmed 59 days post-TAI by ultrasonography (Exp. 2).

Blood was sampled from all cows by puncture of the coccygeal vein or artery into evacuated tubes at nonpregnant diagnosis. Blood samples were collected to determine progesterone concentrations at either day 34 (Exp. 1) or at days 31, 34, 46, and 48 (Exp. 2). Samples were immediately cooled and stored at 5°C for 16 hours. Blood tubes were centrifuged at 1,000 x g for 15 minutes in a refrigerated centrifuge at 5°C for serum separation and harvest. Serum samples were frozen and stored at -20°C until assayed for progesterone by radioimmunoassay.

Results and Discussion

Experiment 1

Only 76% of 1,031 cows had high (≥ 1 ng/mL) progesterone concentrations at day-34 non-pregnant diagnosis. Cows with low (< 1 ng/mL) progesterone concentrations at GnRH-1 and assigned to the day-34 RES-CIDR treatment had greater ($P = 0.028$) P/AI than day-34 RES-CON cows (39.1 vs. 31.3%; Figure 3). In contrast, day-34 RES-CIDR-treated cows with high progesterone concentrations had reduced P/AI compared with cows that received the day-34 RES-CON treatment (27.4 vs. 34.3%).

It seems clear from this experiment that no benefit to pregnancy outcome is accrued from using CIDR in a Resynch application for cows with elevated progesterone (functional corpus luteum; 76% of cows treated) at the onset of a 5-day Resynch program for cows that are between days 34 and 40 since last insemination. Increased P/AI was observed in cows treated with the CIDR insert only when they had low progesterone (no corpus luteum; 24% of cows treated) at the onset of RES.

Experiment 2

The proportion of cows with high progesterone on day 31 was 70.6%. More ($P < 0.001$) cows ovulated after Pre-GnRH of day-31 PG-3-G than for day-41 RES-CON or day-41 RES-CIDR (Table 1). More ($P < 0.001$) PG-3-G cows had luteolysis after Pre-PG on day 31 than other treatments (Table 1). The proportion of cows with high progesterone on day 41 at GnRH-1 tended ($P = 0.10$) to be greater for PG-3-G than for other treatments (Table 1). The P/AI was greater in cows starting RES on day 41 when progesterone was low (44%) than when it was high (33%), but no overall treatment differences in P/AI were detected 32 days after TAI (PG-3-G = 33.3%; day-41 RES-CON = 38.9%; day-41 RES-CIDR = 35.6%; Figure 4).

Some have reported improved P/AI in RES cows in which the RES protocol was delayed after open diagnosis and cows were pretreated with PG before initiating the RES protocol. Most of the advantage of using PG is accrued by inseminating those cows that are detected in estrus and enrolling only those not yet inseminated in the follow-up RES protocol. Therefore, although no P/AI advantage occurred after pretreating open cows with PG, the major benefit accrued when detection of estrus was included as part of the program before applying the RES protocol to cows not inseminated.

We concluded that improved P/AI occurred only when applying the CIDR insert to cows with low progesterone when initiating the 5-day RES on d 34 (Exp. 1). Although d 31 PG-3-G increased rates of luteolysis and ovulation before RES, no increase in P/AI was detected compared with the 5-day RES started on d 41 with or without a CIDR insert (Exp. 2).

Table 1. Ovarian characteristics during Experiment 2 treatment protocols

Item	Treatment			<i>P</i> -values
	Day-31 PG-3-G	Day-41 RES-CON	Day-41 RES-CIDR	
Pre-PG/GnRH				
Progesterone \geq 1 ng/mL, %	74.8	69.3	67.6	0.42
Luteolysis ¹ , %	73.8 ^a	10.4 ^b	8.7 ^b	0.001
Ovulation after Pre-GnRH ² , %	60.4 ^a	12.5 ^b	17.1 ^b	0.001
GnRH-1				
Progesterone \geq 1 ng/mL, %	76.6 ^a	65.5 ^b	70.2 ^{a,b}	0.05
CL present, %	78.5	73.4	67.0	0.13
Ovulation after GnRH ² , %	42.1 ^a	36.3 ^{a,b}	28.3 ^b	0.05
Double ovulation after GnRH ³ , %	8.4	4.4	5.7	0.46
GnRH-2				
Luteolysis ⁴ , %	96.6	93.5	95.7	0.63
Ovulation after GnRH ² , %	88.6	85.0	84.9	0.67
Double ovulation after GnRH ³ , %	19.1	28.3	24.5	0.18

^{a,b} Proportions within each row with different superscripts differ ($P < 0.05$).

¹ Luteolysis was determined by changes in progesterone concentration between Pre-PG (\geq 1 ng/mL) and Pre-GnRH injections 72 hours later ($<$ 1 ng/mL).

² Ovulation of one follicle after GnRH administration.

³ Ovulation of more than one follicle after GnRH administration.

⁴ Luteolysis was determined by changes in progesterone concentration between PG-2 (\geq 1 ng/mL) and GnRH-2 injections 72 hours later ($<$ 1 ng/mL).

REPRODUCTION

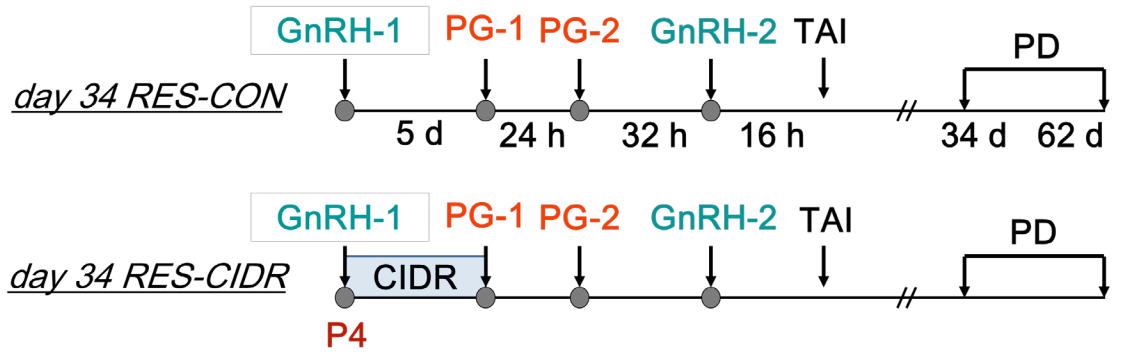

Figure 1. Experimental design for Experiment 1. PG = PGF_{2a}, GnRH = gonadotropin-releasing hormone, TAI = timed artificial insemination, CIDR = controlled internal drug release insert (progesterone impregnated), P4 = progesterone, PD = pregnancy diagnosis.

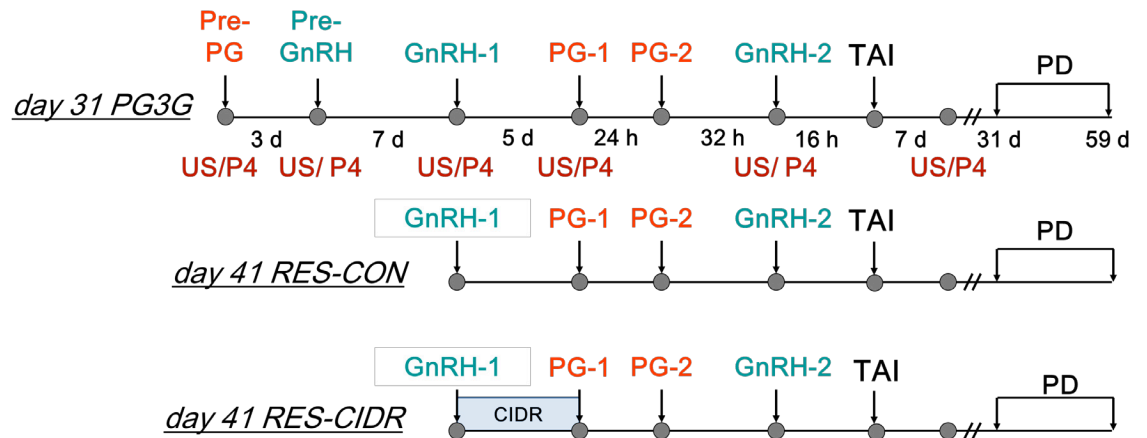

Figure 2. Experimental design for Experiment 2. PG = PGF_{2a}, GnRH = gonadotropin-releasing hormone, TAI = timed artificial insemination, CIDR = controlled internal drug release insert (progesterone impregnated), P4 = progesterone, PD = pregnancy diagnosis, US = ovarian ultrasound examination.

REPRODUCTION

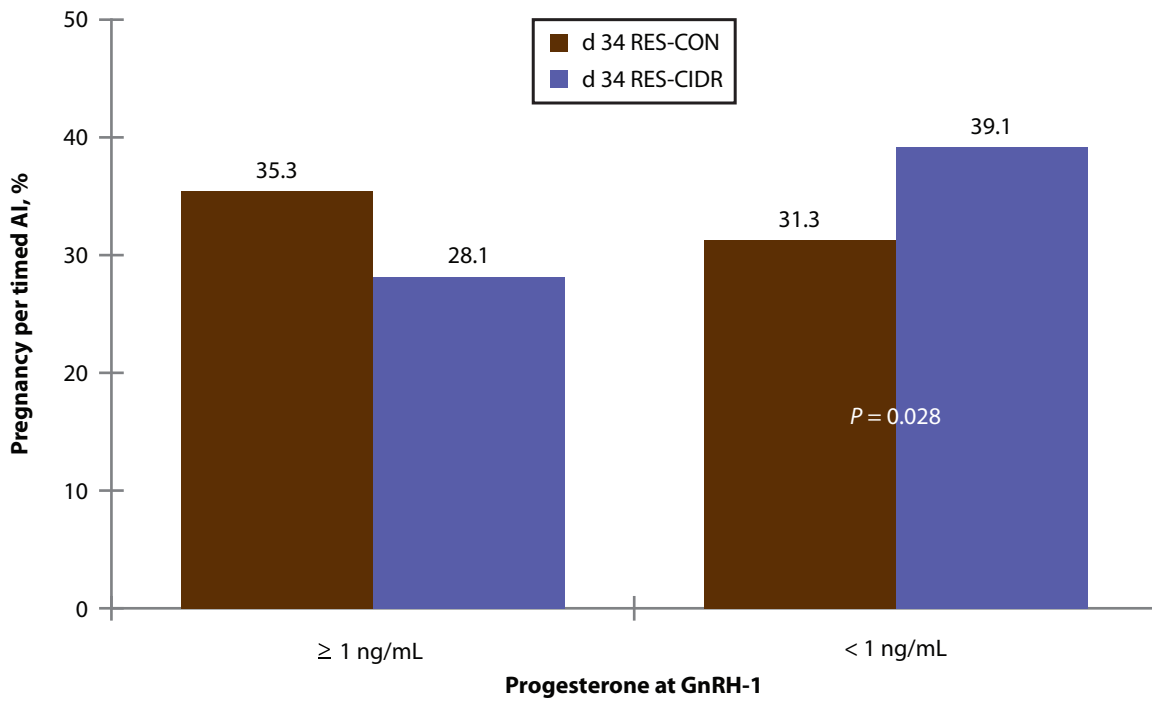

Figure 3. Pregnancy per timed AI determined 34 days post-insemination (Exp. 1) based on treatment and progesterone concentration at the onset of treatment.

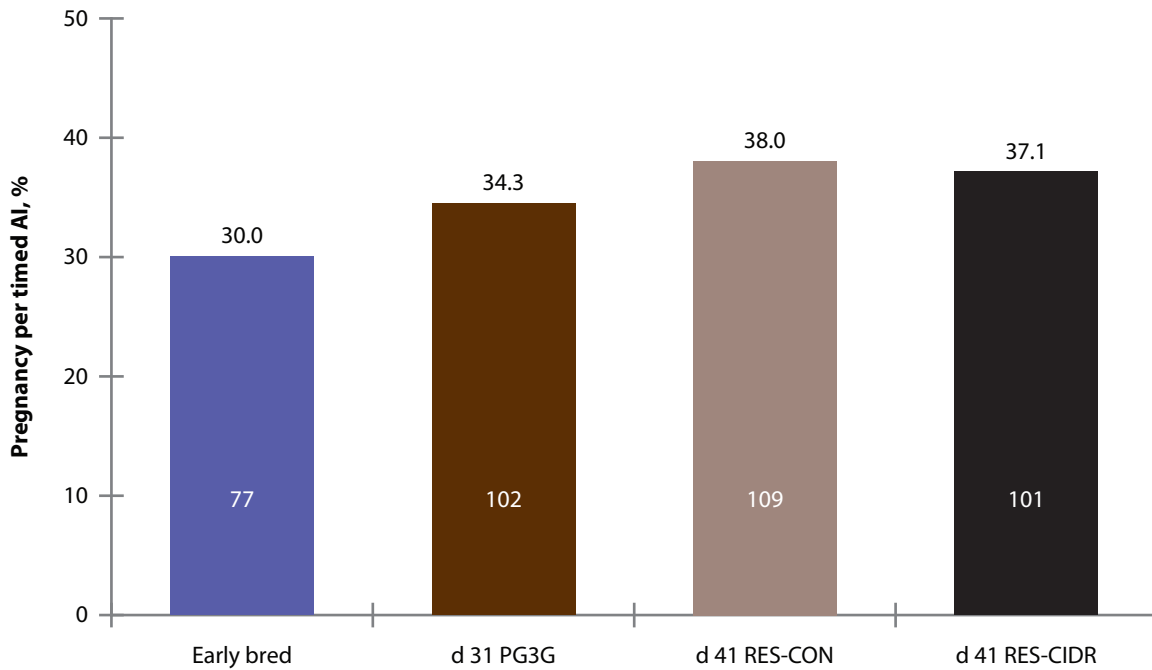

Figure 4. Pregnancy per timed AI at 32 days post-insemination for Experiment 2.

Automated Activity Monitoring of Estrus and Time of Ovulation

J. S. Stevenson

Summary

Detection of estrus can be facilitated by use of automated activity monitors that measure physical activity. Increased physical activity is largely correlated with estrus. Our objective was to determine when ovulation occurs relative to increased physical activity so we could recommend optimal timing of insemination to maximize conception rates in lactating dairy cows. Cows ($n = 65$) were fitted with pressure-sensitive rump-mounted transmitters (HeatWatch; **HW**) that are activated by a mounting herdmate to indicate standing estrus. The same cows also were fitted with neck-mounted activity monitors (Select Detect; **SD**). Additional cows ($n = 68$) were fitted with only the activity monitor. Beginning approximately 14.5 hours after the individual activity monitor on a cow reached a set threshold, transrectal ultrasonography was used to identify the ovarian preovulatory follicle. Repeated ovarian scans were performed every 3 hours until ovulation occurred or 36 hours after threshold was reached. Although average intervals to ovulation actually differed ($P < 0.05$) by only 1.5 h (27.2 ± 0.6 h for HW vs. 25.7 ± 0.4 h for SD), deviations between onsets differed by 2.0 ± 0.4 h (increased activity preceded time of standing to be mounted). Increased physical activity tended to increase before the first standing event and endured longer than the duration of estrus measured by HW. We concluded that the activity monitor was a reliable tool to detect estrus, and ovulation occurred at similar intervals from increased activity as from the first standing event associated with estrus.

Key words: estrus, ovulation, physical activity

Introduction

The latest version of electronic estrus-detection aids that appeared in the early part of this decade are neck-mounted activity tags containing a microprocessor and a 2- or 3-dimensional activity sensor. Monitoring activity has formed the basis for many pedometer or neck-mounted monitor systems marketed to the dairy industry because increased activity (motion, movement, walking, etc.) is correlated with estrus; activity increases up to 400% in 93% of estrous periods. One limitation of any system is the lesser activity associated with estrus for cows maintained in tie-stalls compared with free stalls or for cows in total confinement on concrete compared with dirt.

The newest generation of activity monitors employs an accelerometer device. Accelerometers are small (0.01×0.01 inch), reliable, and durable. Accelerometers were first developed for the military, aerospace, and automotive industries and have the capacity to detect motion in all three spatial planes. Now they are more popularly used in industrial, medical, and consumer devices with any number of applications. The accelerometer allows accurate measurement of cow movement. The activity tag monitors specific estrus-related movement and its intensity, resulting in estrus-detection accuracies of up to 90%. By 2010, the best-selling system in the world, with approximately 1 million estrus-detection tags sold, demonstrated that dairy farmers were willing to invest in technologies that provide a real solution to the problem of detection of estrus. These systems are effective management tools in the AI program because their use will increase estrus-detection rates, which will increase AI service rates and result in more pregnan-

cies. At least four patents have been issued describing some type of transponder system that is capable of detecting movement or motion and includes the ability to be interrogated in the milking parlor or send signals via wireless radiotelemetry.

Activity monitors periodically record data that are downloaded wirelessly to a base station or when the activity monitor is interrogated in the milking parlor, common feeding stations, or other high-traffic areas. The software operating on a personal computer downloads the activity data from the computer interface to the software for analysis. The activity analysis program algorithm examines within-cow activity to assist in detecting the amount of current activity as a function of the cow's most recent activity baseline. When current activity meets or exceeds a set threshold, the cow's identification is flagged by the software for further inspection and possible insemination.

Three previous studies have reported that time of ovulation was in reasonable agreement with the gold standard study, where ovulation occurred at 27.6 ± 5.4 h after the onset of estrus based on actual standing events associated with estrus. From the literature, it also seems likely that increased activity is largely correlated with the onset of standing estrus in studies where simultaneous measures were made.

The objective of this study was to determine when the ovulatory follicle disappears (ovulation) in lactating dairy cows enrolled in an AI program exposed to Select Detect activity monitor system and HeatWatch heat-detection systems.

Experimental Procedures

Lactating dairy cows enrolled in AI program were fitted with HeatWatch (**HW**; $n = 65$; Cow Chips LLC, Manalapan, NJ) heat-detection transmitters and Select Detect (**SD**; Select Sires Inc., Plain City, OH) accelerometer activity monitors. An additional 68 cows were fitted with only the SD monitors. Combining technologies allowed comparisons of the onset of estrus (first mount received per HW) with the timing of increased activity (first achieved threshold) as determined by an accelerometer activity system. When lactating dairy cows calved, they were fitted with SD accelerometer collars and HW transmitters to facilitate simultaneous collection of estrus and ovulation events. Cows enrolled in the study were set up for first AI beginning at 50 DIM by receiving either 25 mg prostaglandin F_{2a} (**PG**) or 100 μ g gonadotropin-releasing hormone (**GnRH**) i.m. that preceded the PG injection by 7 days to induce estrus. Cows identified in estrus either before or after first AI were studied.

When a cow was detected in estrus (at least 1 standing event), the hourly activity count reached a threshold (based on SD software), or both, transrectal ovarian scans were initiated beginning 14.5 ± 0.5 h later and continued every 3 h until the ovulatory follicle(s) disappeared or until 36 h had passed. At the initial scan, all follicular structures were mapped and sized with electronic calipers. The largest two follicles were monitored until either or both disappeared. A blood sample was collected at the first ovarian scan to measure concentrations of progesterone (< 1 ng/mL, which was indicative of true estrus).

Results and Discussion

Of 132 cows enrolled in the ovulation study, 117 (89%) had concentrations of progesterone < 1 ng/mL (mean = 0.11 ng/mL) and 15 (12%) had elevated concentrations of progesterone (mean = 5.35 ng/mL) at the first ovarian scan. Eleven of the 15 high-progesterone cows were

identified falsely by activity monitors (false positives). Of these 11 cows, 3 occurrences of 2 cows were detected together, and 1 occurrence of 5 cows was detected together within 1 to 5 h of each other. Of 117 low-progesterone cows, 88.6% ovulated (95.3% ovulated <36 h after detection by the activity monitor). Of the total data collected with the activity monitor, 59 of 106 ovulating cows also had HW-transmitter data.

Figure 1 illustrates the relative proportion of cows that ovulated at various intervals after detection by either standing to be mounted or by reaching the activity threshold. Although average intervals to ovulation actually differed ($P < 0.05$) by only 1.8 h (26.8 ± 0.7 h for HW vs. 25.0 ± 0.7 h for SD), actual deviations between onsets differed by 1.7 ± 0.4 h (increased activity was preceded by the first standing to be mounted event). Interval to ovulation detected by HW in our study and in an earlier report (27.6 h) was similar. For all 97 cows with activity monitors and verified ovulation, average interval to ovulation after reaching threshold was 25.7 ± 0.4 h. Based on 95% confidence intervals, time of ovulation after start of increased activity or first standing event consistently overlapped.

Mean interval to ovulation after the end of estrus or end of increased activity was greater ($P < 0.001$) for HW than for SD, respectively, whereas duration of estrus was greater ($P < 0.001$) for SD than HW (Table 1).

The close relationship between onset of standing-to-be-mounted and increased activity is illustrated in Figure 2. Large correlations were detected between estrual and ovulation traits as defined by HW and SD (Table 2). Near-perfect correlations between HW- and SD-defined onset and end of estrus were detected.

Detection of estrus is a key element in successful artificial insemination programs in dairy herds. Although timed insemination programs are popular and pregnancy outcomes are generally good, technologies available to detect estrus have proven effective in increasing heat-detection and service rates. The studied automated activity monitors closely identified onset of estrus compared with standing-to-be-mounted activity identified by HeatWatch. Time of ovulation relative to onset of estrus was similar between methods. Furthermore, with one activity accelerometer system, consistency of ovulation time relative to both onset and end of activity are very predictable. To maximize pregnancy outcome based on ovulation times identified with the SD system, insemination should occur between 12 and 18 hours after the first identified threshold of physical activity.

Table 1. Time of ovulation relative to estrus activity determined by automated activity accelerometers (Select Detect [SD]) or by standing to be mounted (stand) determined by HeatWatch [HW])

Item	SD	HW	HW	SD	HW	SD	HW
	Duration of activity ¹ , h	Duration of estrus, h	Standing events, no.	Ovulation after activity start ² , h	Ovulation after first stand, h	Ovulation after activity end ³ , h	Ovulation after last stand, h
Cows, no.	44	54	59	59	59	44	54
Mean	11.4 ± 0.9	5.7 ± 0.9	6.1 ± 1.2	25.0 ± 0.7	26.8 ± 0.7	13.4 ± 0.9	21.3 ± 0.9
95% CI	9.6 – 13.1	4.0 – 7.4	3.7 – 8.5	23.6 – 26.3	25.5 – 28.2	11.5 – 15.3	19.5 – 23.2

¹Duration above threshold.²Timed when activity increased above threshold.³Timed when activity decreased below threshold.**Table 2. Correlations of HeatWatch and Select Detect activity monitor defined estrual and ovulation traits**

Trait	Simple correlation	<i>P</i> -value
Onset of estrus to ovulation	0.722	<0.001
End of estrus to ovulation	0.341	=0.027
Onset of estrus	1.000	<0.001
End of estrus	0.999	<0.001
Duration of estrus	0.219	=0.193

REPRODUCTION

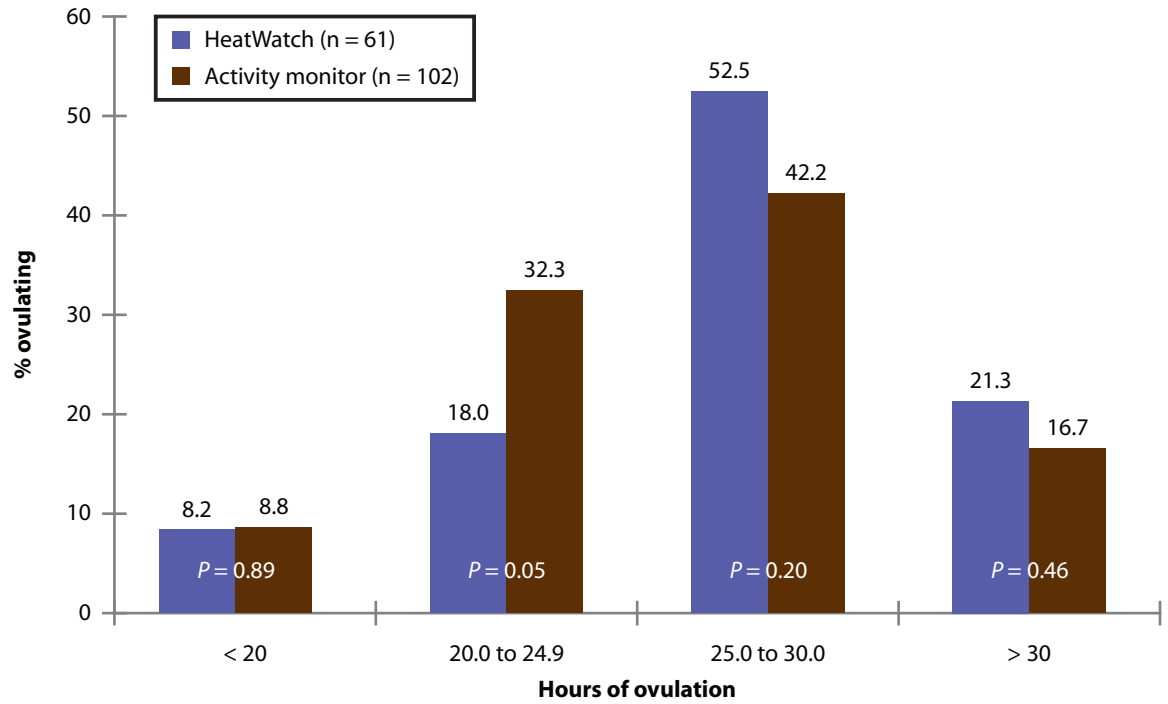

Figure 1. Proportion of cows that ovulated after onset of estrus (standing to be mounted as determined by HeatWatch) or after reaching threshold (based on Select Detect activity monitors).

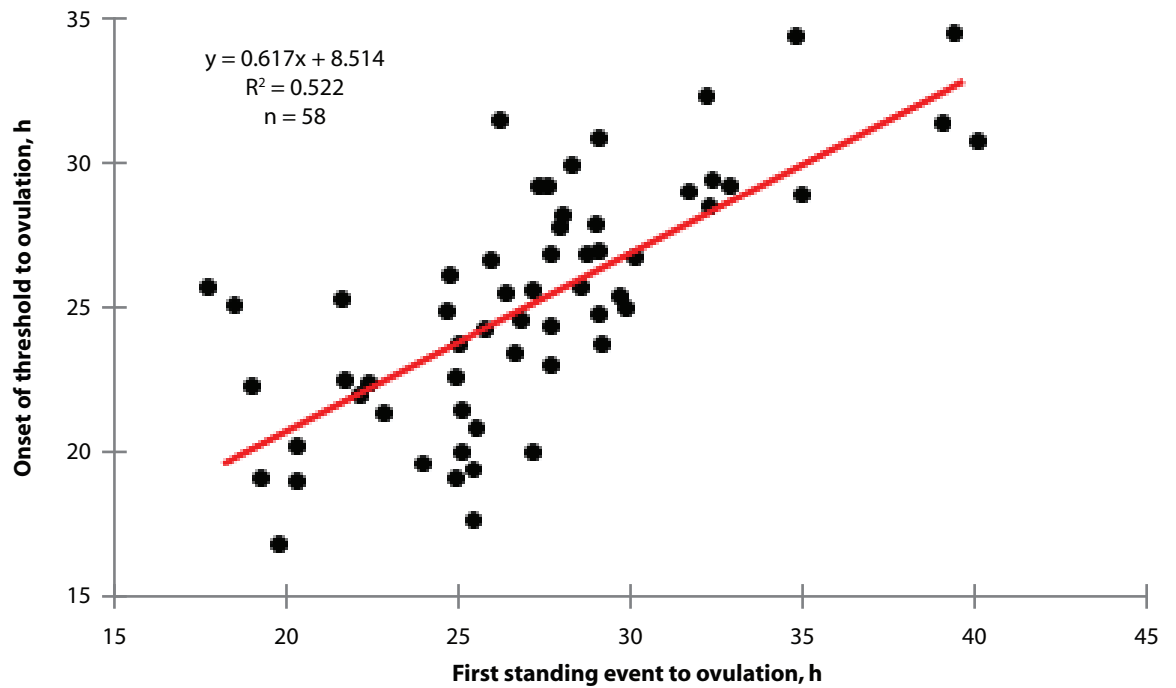

Figure 2. Linear relationship between time of first standing event and increased activity relative to time of ovulation.

Consumer Acceptance of Cysteine-Enhanced Yogurt

S. Bala and K.A. Schmidt

Summary

Within cells, cysteine can be synthesized from methionine by the enzyme γ -cystathionase. Cysteine is then utilized to synthesize glutathione, which has many functions in cells that contribute to good health. Certain subpopulations, however, especially the elderly, have decreased γ -cystathionase activity. Thus, dietary cysteine may be beneficial in maintaining health. In previous reports, a yogurt with enhanced cysteine content was made by incorporating whey protein isolate (**WPI**) into the mix's dairy base combined with a process treatment to minimize cysteine denaturation. The gel quality of this yogurt matched or exceeded that of a yogurt that was formulated and processed to mimic an industrially manufactured product. More importantly, the cysteine content was 3 times greater, and the gel quality was stable throughout a 60-day shelf life. With this evidence, the question remained whether the flavor of an enhanced cysteine yogurt would be acceptable. Because addition of whey-based products in yogurt has been reported to affect flavor and texture properties, this study was undertaken to determine consumer liking of a high-cysteine yogurt. Formulas were adjusted to contain sugar and vanillin, and these mixes were processed to produce high-cysteine and low-cysteine yogurts. Yogurts were stored at 4°C for 1 week, then evaluated by a group of 119 consumers. Consumers rated yogurts based on their liking of appearance, thickness, flavor, aftertaste, and overall acceptability using a 9-point hedonic scale ranging from dislike extremely (1) to like extremely (9). Overall, consumers rated the high- and low-cysteine yogurts similarly for flavor (6.1), aftertaste (6.1), and overall acceptability (6.3), with mean scores corresponding to "like slightly" to "like moderately." Consumers liked the thickness of the high-cysteine yogurt more than the low-cysteine yogurt but liked the appearance of the low-cysteine yogurt more than the high-cysteine yogurt. The high-cysteine yogurt had approximately 3 times more cysteine than the low-cysteine yogurt. These results indicate that a high-cysteine yogurt may be a useful and acceptable food system to provide dietary cysteine.

Key words: yogurt, cysteine, consumer preference

Introduction

Yogurt popularity and sales continue to grow in the U.S. Yogurt consumption is influenced by many factors, but its nutritional profile and health benefits are most prominent. Whey proteins in milk are rich sources of the sulfur-containing amino acids, such as cysteine and methionine, and yogurt has the potential to be one of the best dietary sources of cysteine. Heat treatments in excess of 70°C denatures whey proteins and decreases the bioavailability of some amino acids, cysteine in particular. High heat treatment conditions are desirable in yogurt, because denatured whey proteins contribute firmness and water-holding ability to the gel.

Recent reports from the Centers for Disease Control and Prevention indicate that 20.1 million Americans 40 years and older have cataracts and forecast that this number will increase to 30.1 million by 2020. Research has shown that as mammals age, the enzyme γ -cystathionase (which converts methionine to cysteine) tends to diminish, and the loss of this enzyme in the eye lenses has been implicated in cataract formation. All of these data indicate that people prone

to cataracts may benefit from consumption of dietary cysteine as a means to compensate for diminished γ -cystathionase activity.

We previously reported (Dairy Research 2012, pp 29-34) that yogurt with an elevated cysteine content could be made by formulating a yogurt mix with nonfat dry milk (NDM) and whey protein isolate (WPI) and using a heat treatment that assured pasteurization and minimized changes to cysteine. This enhanced-cysteine yogurt was found to have greater firmness, reduced syneresis, and most importantly, 3 times more cysteine content compared with yogurt made to mimic commercial manufacture. Moreover, these quality attributes were stable throughout a 60-day shelf life.

Different sensory techniques have been used to characterize flavor, color, appearance, and liking of yogurt. Whey proteins have been reported to influence the sensory properties of yogurt depending on the source and concentration of the whey protein. For instance, using descriptive analysis, the addition of whey protein products to a yogurt mix have been reported to increase the chalkiness, thickness, lumpiness, whey flavor, creaminess, and yellowness. On the other hand, consumer acceptance testing is used to evaluate the liking of products with panelists who are not trained. As early as the 1980s, reports in the literature have indicated that yogurts containing whey protein concentrate (WPC) had acceptable texture and appearance scores compared with yogurts containing other protein substitutes such as casein and sodium caseinate. More recently, researchers have reported that consumers liked the appearance, flavor, and texture of yogurts containing WPC (6%) and skim milk powder, and the overall impression of the yogurts was favorable.

As these results indicate, addition of whey products to yogurt may affect the flavor and texture profiles of the final product. Because we added a whey protein product and modified the process, the question of whether consumers would like a high-cysteine yogurt remained. Thus, this research project was undertaken to: (1) compare consumer liking of a high-cysteine and low-cysteine yogurt and (2) assess consumer willingness to buy such a product.

Experimental Procedures

Low-heat NDM, sugar, vanillin, WPI, and yogurt culture were obtained from commercial suppliers or local stores and maintained at -2 or -10°C (culture) until usage. Two yogurts were formulated: (1) a low-cysteine yogurt consisting of 12.5% (w/v) NDM and 5% (w/v) sugar; and (2) a high-cysteine yogurt consisting of 2.5% (w/v) WPI, 10% (w/v) NDM, and 5% (w/v) sugar. These ingredients were mixed in deionized, distilled water at 22 to 24°C for 30 minutes then heated, with the low-cysteine mix at 70°C for 20 minutes and the high-cysteine mix at 90°C for 7 minutes. Mixes were cooled to 43°C, and 1.6% (w/v) of vanillin flavor was added along with 0.6% (w/v) of the culture containing *Lactobacillus delbrueckii* ssp. *bulgaricus* and *Streptococcus salivarius* ssp. *thermophilus*, stirred well, packaged, and incubated at $43 \pm 1^\circ\text{C}$ until pH 4.5 to 4.6. Samples were removed from the incubator and placed in cold storage ($4 \pm 1^\circ\text{C}$). On the following day, the mixes were stirred with a hand mixer for 5 minutes at speed 3 and returned to their containers and stored at $4 \pm 1^\circ\text{C}$ until the day of evaluation (sensory on day 7, physical and chemical analyses on day 1).

To evaluate low-cysteine and high-cysteine yogurts for consumer acceptance, a consumer panel was recruited from the general Kansas State University community. Panelists were screened on age (≥ 18 years), interest in consuming yogurt, and lack of food allergies or intolerances. Panel-

ists completed consent and demographic forms and were asked to describe their yogurt consumption frequency.

For the study, panelists were provided a ballot consisting of a 9-point hedonic scale (1 = dislike extremely, 5 = neither like nor dislike, 9 = like extremely) for the attributes of appearance, thickness, flavor, aftertaste, and overall acceptability. At the end of each ballot, panelists were asked to indicate if they were willing to buy the product (yes or no) and if they had any specific comments to share. Panelists were provided water to clean their palates between samples, and each sample and ballot were presented individually.

About an hour before serving, approximately 15 g of each yogurt sample was placed in a 60-mL plastic cup, coded with a random three-digit number, covered with a lid, and returned to cold storage. Serving order (high- then low- and low- then high-cysteine) was randomized. After evaluation of the two samples, panelists were given coupons for free ice cream cones at Call Hall Dairy Store, Kansas State University, Manhattan, KS.

Yogurts were also assessed for consistency, cysteine content, pH, firmness, syneresis, and whiteness index following published methods for stirred-style yogurt. The design was a randomized complete block design with high-cysteine and low-cysteine yogurt as treatments (2) and panelists (112) as blocks. Statistical analysis was done using SAS (SAS Institute Inc., v 9.3, Cary, NC). Analysis of variance results for significant ($P < 0.05$) effects were further analyzed.

Results and Discussion

Table 1 shows the results of the chemical and functional tests of the high-cysteine and low-cysteine yogurts. Because only one batch was made, these numbers reflect the average of the repeated measures of one day's production. The low-cysteine and high-cysteine yogurts varied (Table 1). The high-cysteine yogurt had 3 times more cysteine and 6.4 times less syneresis, was 1.5 times more firm and consistent, but had a lower whiteness index (indicating it was less white) than the low-cysteine yogurt. The pH of the yogurts did not differ. Despite the fact that these yogurts contained additional ingredients (flavor and sweetener) and were made as a stirred-style yogurt vs. set-style yogurt, these results show the same trends as our earlier studies.

One hundred and nineteen panelists (43 males and 76 females) participated in the evaluation. Demographically, 24 panelists ranged from 18 to 20 years, 55 ranged from 21 to 25 years, 20 ranged from 26 to 40 years, and 21 were >40 years. Twenty-eight percent were married, and 72% reported themselves as single. In ethnicity, 67% were Caucasian, 21% were Asian, 5% were African-American, 4% were Hispanic, and 3% indicated other. Frequency of yogurt consumption (self-reported) is shown in Figure 1. Overall, 17 panelists consumed yogurt daily, 45 consumed it 2 to 3 times weekly, 26 consumed it once weekly, 24 consumed it once monthly, and 7 never consumed yogurt. Based on recommendations from sensory scientists, these 7 consumers were removed from the dataset; thus, further analysis and results are based on the remaining 112 judgments.

The consumer liking results for appearance, thickness, flavor, aftertaste, and overall acceptance are shown in Figure 2. Analyses indicated no significant differences between low-cysteine and high-cysteine yogurt for the liking of aftertaste, flavor, and overall acceptability. In contrast, differences ($P < 0.05$) were detected in sensory scores for liking of appearance and thickness.

Appearance of the low-cysteine yogurt had greater liking (6.7 vs. 6.2) than the high-cysteine yogurt. These numbers correspond to “like slightly” (6) to “like moderately” (7). The difference in liking may be due to the color properties of yogurt, because the high-cysteine yogurt had a lower whiteness index than the low-cysteine yogurt (65.11 vs. 68.22; Table 1). In contrast, texture of the high-cysteine yogurt was liked more than the low-cysteine yogurt (6.4 and 5.8, respectively). These scores fall between “neither likes nor dislikes” (5) and “like moderately” (7). Considering the results in Table 1, instrumental analysis indicated that the high-cysteine yogurt was 1.5 times more consistent (thick) and firm than the low-cysteine yogurt, which may be responsible for the texture differences.

Overall, the aftertaste, flavor, and overall acceptability means for low-cysteine and high-cysteine yogurts ranged from 6.1 to 6.3, corresponding to “like slightly” to “like moderately.” The liking of flavor (6.1) and aftertaste (6.1) of the low-cysteine and high-cysteine yogurts was close to the “like slightly” rating, which agrees with previous work showing that yogurt liking did not differ in appearance and flavor with addition of WPC, or in this case, WPI.

The question concerning willingness to buy was used to subset the panelists for further analysis. Results indicated that 59 and 61%, respectively, of the panelists were willing to buy the high-cysteine and low-cysteine yogurts (Table 2). To further understand the willingness-to-buy-yogurt responses, Venn diagrams were made based on gender capturing the willingness to buy either or both yogurts (Figures 3 and 4). Overall, 56 females and 34 males indicated that they would buy at least one of these yogurts. From Figure 3, 15 females indicated they were willing to buy only the high-cysteine yogurt, 13 females indicated they were willing to buy only the low-cysteine yogurt, and 28 females indicated they were willing to buy both yogurts. On the other hand, 7 males indicated they were willing to buy only the high-cysteine yogurt, 10 males indicated they were willing to buy only the low-cysteine yogurt, and 17 males were willing to buy both yogurts. Overall, about 60% of the panelists showed willingness to buy the high-cysteine yogurt.

The hedonic scores for the 5 attributes were obtained based on the willingness to buy each yogurt, and the hedonic mean scores for the attributes are shown in Table 3. Sixty-seven panelists were willing to buy the high-cysteine yogurt, whereas 68 were willing to buy the low-cysteine yogurt; likewise, 45 and 44 panelists were not willing to buy the high-cysteine and low-cysteine yogurt, respectively. Obviously, the subset of not willing to buy had lower corresponding hedonic scores (by at least 1 point) for all 5 attributes than the hedonic mean scores from those willing to buy (Table 3). From those willing to buy at least one of the yogurts, significant differences were again observed only for liking of thickness and appearance. The liking of flavor, aftertaste, and overall quality were similar between these two groups. Considering the subset of the panelists willing to buy at least one of the yogurts, the 10 hedonic scores ranged from “like slightly” (6) to “like moderately” (7). Further research is warranted to optimize texture and appearance of the yogurt as well as to conduct animal studies to determine if a high-cysteine yogurt could increase glutathione contents in tissues or muscles.

Table 1. Chemical and functional properties of yogurts containing different levels of cysteine¹

	Consistency, cm	Cysteine, mg/L	Firmness, g	pH	Syneresis, %	Whiteness index
High-cysteine	6.4	409.6	39.20	4.50	0.790	65.11
Low-cysteine	10.1	128.5	25.63	4.49	5.065	68.22

¹High-cysteine yogurt: nonfat dry milk + whey protein isolate (NDM + WPI) base processed at 70°C for 20 minutes; low-cysteine yogurt: NDM base processed at 90°C for 7 minutes.

Table 2. Total and gender numbers of 112 people willing to buy high-cysteine and low-cysteine yogurts¹

Willing to buy	High-cysteine yogurt	Low-cysteine yogurt
Yes	67 (F:43, M:24)	68 (F:41, M:27)
No	45 (F:31, M:14)	44 (F:33, M:11)

¹High-cysteine yogurt: nonfat dry milk + whey protein isolate (NDM + WPI) base processed at 70°C for 20 minutes; low-cysteine yogurt: NDM base processed at 90°C for 7 minutes.

F: Female, M: Male.

Table 3. Mean hedonic scores¹ for high-cysteine and low-cysteine yogurts, based on willingness to buy

Willingness to buy	Attribute ²	High-cysteine yogurt ³	Low-cysteine yogurt ³
Yes	Appearance	6.6	7.1
	Thickness	6.9	6.4
	Flavor	6.9	7.1
	Aftertaste	6.6	7.0
	Overall acceptability	6.9	7.3
No	Appearance	5.4	6.0
	Thickness	5.6	4.8
	Flavor	4.9	4.8
	Aftertaste	5.0	4.9
	Overall acceptability	5.0	5.0

¹Yes (n = 67) and no (n = 45) for high-cysteine yogurt; yes (n = 68) and no (n = 44) for low-cysteine yogurt. 1 = dislike extremely, 2 = dislike very much, 3 = dislike moderately, 4 = dislike slightly, 5 = neither like nor dislike, 6 = like slightly, 7 = like moderately, 8 = like very much, 9 = like extremely.

²Ballot order.

³High-cysteine yogurt: nonfat dry milk + whey protein isolate (NDM + WPI) base processed at 70°C for 20 minutes; Low-cysteine yogurt: NDM base processed at 90°C for 7 minutes.

DAIRY FOODS

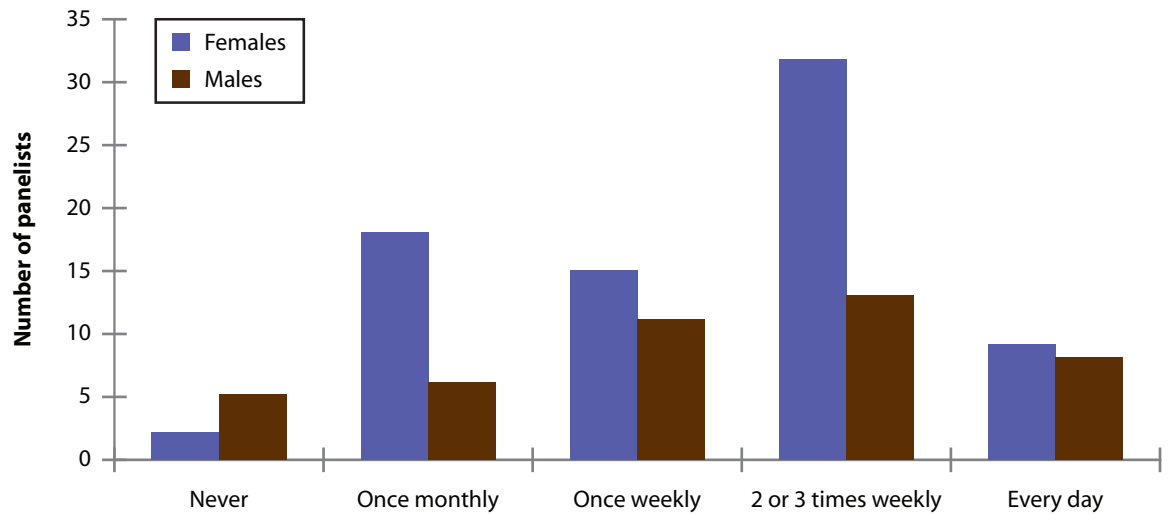

Figure 1. Frequency of yogurt consumption by panelists, based on gender (female, n = 76 and male, n = 43).

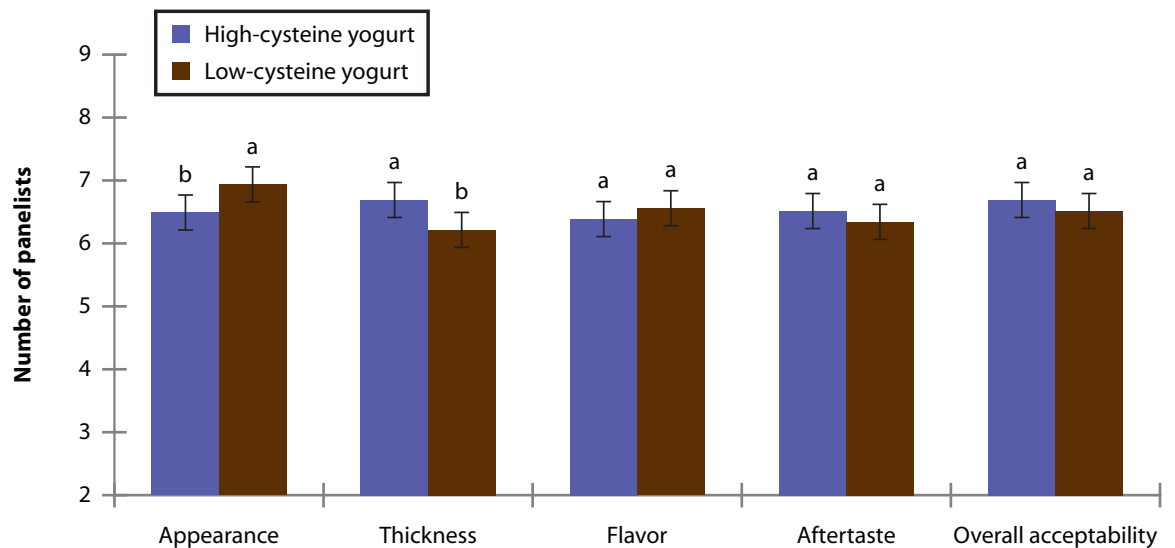

Figure 2. Mean hedonic scores for liking of appearance, thickness, flavor, aftertaste, and overall liking of high-cysteine and low-cysteine yogurts. ^{a,b} Bars with different letters within attribute differ ($P \leq 0.05$) (n = 112). Hedonic scale: 1 = dislike extremely, 2 = dislike very much, 3 = dislike moderately, 4 = dislike slightly, 5 = neither like nor dislike, 6 = like slightly, 7 = like moderately, 8 = like very much, 9 = like extremely. High-cysteine yogurt: nonfat dry milk + whey protein isolate (NDM + WPI) base processed at 70°C for 20 minutes; low-cysteine yogurt: NDM base processed at 90°C for 7 minutes.

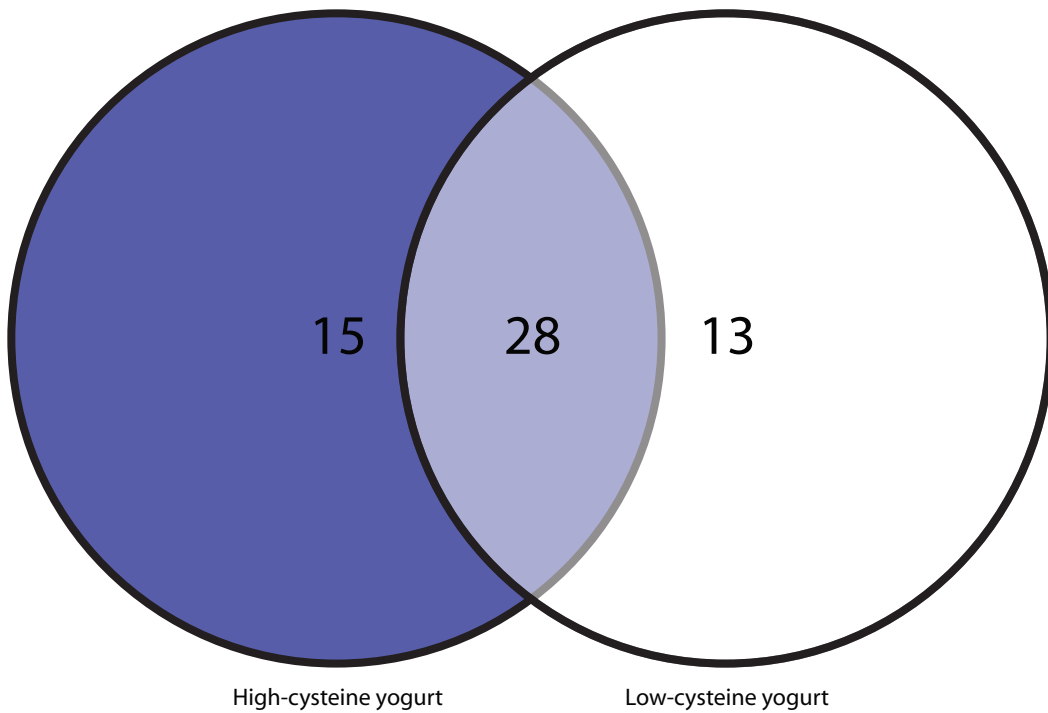

Figure 3. Venn diagram of female panelists (n = 56) who indicated willingness to buy high-cysteine and low-cysteine yogurts. High-cysteine yogurt: nonfat dry milk + whey protein isolate (NDM + WPI) base processed at 70°C for 20 minutes; Low-cysteine yogurt: NDM base processed at 90°C for 7 minutes.

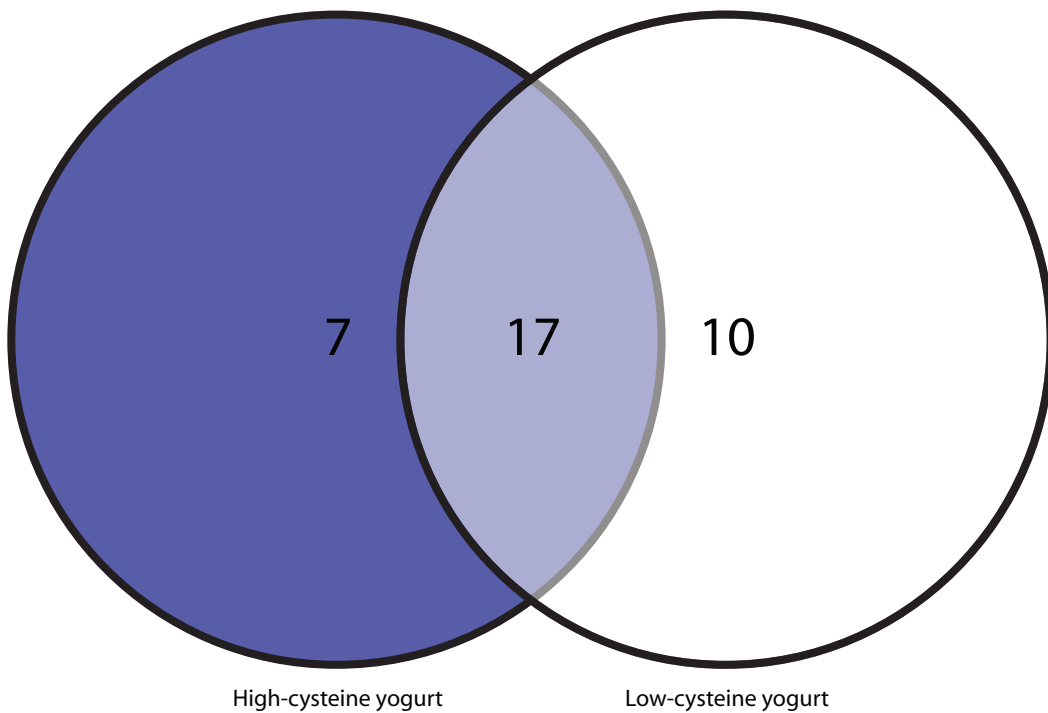

Figure 4. Venn diagram showing the male panelists (n = 34) who indicated willingness to buy high-cysteine and low-cysteine yogurts. High-cysteine yogurt: nonfat dry milk + whey protein isolate (NDM + WPI) base processed at 70°C for 20 minutes; Low-cysteine yogurt: NDM base processed at 90°C for 7 minutes.

Acknowledgments

Appreciation is expressed to the following organizations for their support of dairy teaching, research, and extension at Kansas State University during 2012–2013.

Aerotech, Mason, MI
AgTech, Inc., Manhattan, KS
American Feed Industry Association, Arlington, VA
Arm & Hammer Animal Nutrition, Princeton, NJ
Balchem Corporation, New Hampton, NY
Borregaard LignoTech, Rothschild, WI
BouMatic, Madison, WI
Cargill, Inc., Wayzata, MN
Consolidated Container Company, Minneapolis, MN
Dupont Nutrition and Health (Danisco USA), New Century, KS
Dekalb Asgrow, St. Louis, MO
DeLaval, Kansas City, MO
Diamond V Mills, Cedar Rapids, IA
Elanco Animal Health, Greenfield, IN
Environmental Health Protection Agency, Washington, DC
Glanbia Nutritionals, Fitchburg, WI
Grain States Soya, West Point, NE
Heart of America Dairy Herd Improvement Association, Manhattan, KS
High Plains Dairy Management Conference
Hubbard Feeds, Mankato, MN
ITW Reflex North America, Des Plaines, IL
Merck Animal Health, Whitehouse Station, NJ
Iowa Limestone, Des Moines, IA
Kansas Agricultural Experiment Station, Manhattan, KS
Kansas Dairy Commission, Wamego, KS
Kansas Farm Management Association, Manhattan, KS
Kansas Health and Environment, Topeka, KS
Kemin Industries, Des Moines, IA
Pfizer Animal Health, Madison, NJ
Quality Liquid Feeds, Dodgeville, WI
Rota-Mix, Dodge City, KS
Select Sires, Plain City, OH
Sweet Bran, Dalhart, TX
USDA National Institute of Food and Agriculture, Washington, DC
Zinpro Corp., Eden Prairie, WI

Appreciation is expressed to Valerie Stillwell for her help in preparing the contents of this publication. The departments of Agricultural Economics and Biological and Agricultural Engineering, and the College of Veterinary Medicine at Kansas State University are recognized for their cooperation and contribution to our dairy research and teaching program.

The Livestock and Meat Industry Council, Inc.

The Livestock and Meat Industry Council, Inc. (LMIC) is a nonprofit charitable organization supporting animal agriculture research, teaching, and education. This is accomplished through the support of individuals and businesses that make LMIC a part of their charitable giving.

Tax-deductible contributions can be made through gifts of cash, appreciated securities, real estate, life insurance, charitable remainder trusts, and bequests as well as many other forms of planned giving. LMIC can also receive gifts of livestock, machinery, or equipment. These types of gifts, known as gifts-in-kind, allow the donor to be eligible for a tax benefit based on the appraised value of the gift.

Since its inception in 1970, LMIC has provided student scholarships, research assistance, capital improvements, land, buildings, and equipment to support students, faculty, and the industry of animal agriculture. If you would like to be a part of this mission or would like additional information, please contact the Livestock and Meat Industry Council/Animal Sciences and Industry, Weber Hall, Manhattan, Kansas 66506 or call 785-532-1227.

LMIC Board Members

Kyle Bauer	Patsy Houghton	Jan Lyons
Joe Downey	Virgil Huseman	Bill Miller
Galen Fink	Justin Janssen	Gina Miller
Mark Gardiner	Dan Johnson	Stanton O'Neil
Craig Good	Larry Jones	Tom Perrier
Lyle Gray	Mark Knight	Rich Porter
Greg Henderson	Pat Koons	Ken Stielow
Roy Henry	Kelly Lechtenberg	Warren Weibert

Royal Board Members

Dell Allen	Henry Gardiner	Phil Phar
Jerry Bohn	Sam Hands	Harland Priddle
Richard Chase	Bernie Hansen	Lee Reeve
Max Deets	Steven Hunt	Don Smith
Calvin Drake	Steve Irsik	Mikel Stout
Stan Fansher	Kenny Knight	Kathleen Strunk
Randy Fisher	Andrew Murphy	Duane Walker

DAIRY RESEARCH 2013

Copyright 2013 Kansas State University Agricultural Experiment Station and Cooperative Extension Service. Contents of this publication may be freely reproduced for educational purposes. All other rights reserved. In each case, give credit to the author(s), Dairy Research 2013, Kansas State University, December 2013. Contribution no. 14-179-S from the Kansas Agricultural Experiment Station.

Brand names appearing in this publication are for product identification purposes only. No endorsement is intended, nor is criticism implied of similar products not mentioned.

Publications from Kansas State University are available at: www.ksre.ksu.edu

KANSAS STATE UNIVERSITY AGRICULTURAL EXPERIMENT STATION
AND COOPERATIVE EXTENSION SERVICE