

# AGRICULTURAL EXPERIMENT STATION

KANSAS STATE COLLEGE OF AGRICULTURE  
AND APPLIED SCIENCE

MANHATTAN, KANSAS

---

## FEEDING RANGE LAMBS IN KANSAS



PRINTED BY KANSAS STATE PRINTING PLANT  
W. C. AUSTIN, STATE PRINTER  
TOPEKA 1940  
18-1644

## TABLE OF CONTENTS

	PAGE
PART I. INTRODUCTION .....	6
Feeding Range Lambs in Kansas.....	6
PART II. SIZE, QUALITY AND TYPE .....	8
Light, medium and heavy feeder lambs.....	8
Quality in feeder lambs.....	11
Types of feeder lambs.....	12
PART III. OBTAINING FEEDER LAMBS .....	17
Number of lambs to feed.....	17
Purchases and contracts .....	17
Contracts for future delivery.....	18
Producer-feeder contracts .....	19
Weight-gain basis .....	19
Joint-investment contract .....	20
Market price agreement.....	20
PART IV. EQUIPMENT FOR FEEDING LAMBS.....	22
Buildings and shelter.....	22
Feed lots and location.....	24
Types of fences.....	26
Arrangement and size of feed lot.....	27
Feeders .....	27
Grain feeders .....	31
Roughage feeders .....	33
Combination feeders .....	34
Self feeders .....	35
Watering devices .....	36
Cutting chute .....	38
PART V. FEEDS AND METHODS USED IN FATTENING LAMBS.....	40
Grain feeds .....	40
Corn .....	40
Grain sorghums .....	41
Wheat .....	41
Barley .....	41
Oats .....	41
Sugar beet by-product concentrates.....	42
Beet molasses .....	42
Beet pulp .....	43
Roughages .....	43
Alfalfa hay .....	43
Grain and forage sorghum roughages.....	44
Prairie hay .....	49
Silage .....	49
Sugar beet tops .....	50

	PAGE
Protein supplements .....	52
Minerals .....	53
Salt .....	53
Ground limestone .....	53
Hand-feeding and self-feeding.....	54
Lambing down corn and grain sorghums.....	55
Fattening lambs on wheat pasture.....	59
PART VI. LAMB FEEDLOT MANAGEMENT.....	62
Getting lambs on feed.....	62
Length of feeding period—Gains to expect.....	67
Shearing feeder lambs .....	67
Avoiding weight losses and death losses.....	68
PART VII. SHIPPING LAMBS .....	76
Sorting for market.....	76
Safe loading of cars.....	78
The feeding-in-transit privilege.....	79
The 28-hour law and the release.....	79

# Feeding Range Lambs in Kansas<sup>1</sup>

By RUFUS F. COX

## PART I

### Introduction

Fattening of range lambs for market has been carried on in Eastern and Northeastern Kansas for some years. This industry has been more or less localized in the section of Kansas lying in or adjacent to the Corn Belt, where alfalfa or clover hay as well as corn is grown, and in the vicinity of the Missouri River markets. Corn with either alfalfa or clover hay and supplemented with cottonseed meal has constituted the more or less standard ration used throughout this section as well as in most of the Corn Belt states for lamb feeding. Linseed meal is often used in place of cottonseed meal, and sometimes timothy hay is used along with, or in place of, the legume hays, but the rations and methods used in that section have been more or less standardized for several years.

Lamb feeding is still an industry of considerable importance in that section of Kansas and is established as a fixed part of the farming program. It is an activity that fits in well with the type of farming in that section of the state, since it usually starts in the fall or early winter when other farm work is not very pressing, and is completed in the spring before field work demands very much time. Furthermore, lambs are frequently used to harvest the crop, particularly corn, and to clean stalk fields.

The feeding of lambs at railroad feeding plants and at other large commercial feeding establishments in Kansas located on the railroads within easy reach of the markets is also a well-established practice that is increasing in volume.

Only recently has extensive feeding of Western lambs gained a foothold in Western Kansas where farming is done on a more extensive scale. Large wheat and grain sorghum fields are the rule for that section of Kansas, while alfalfa is grown generally in the valleys and creek and river bottoms. Not until recently has lamb feeding been deemed advisable in such a system of farming. No notice was given to it or else it was believed that it would not fit in well with the farming operations and there was also some doubt as to whether crops grown in that section were suitable for use in lamb-fattening rations. Furthermore, fencing and other equipment needed for handling livestock were not present on the farms nor were the farmers, for the most part, acquainted with lamb-feeding problems.

1. Contribution No. 136 from the Department of Animal Husbandry.

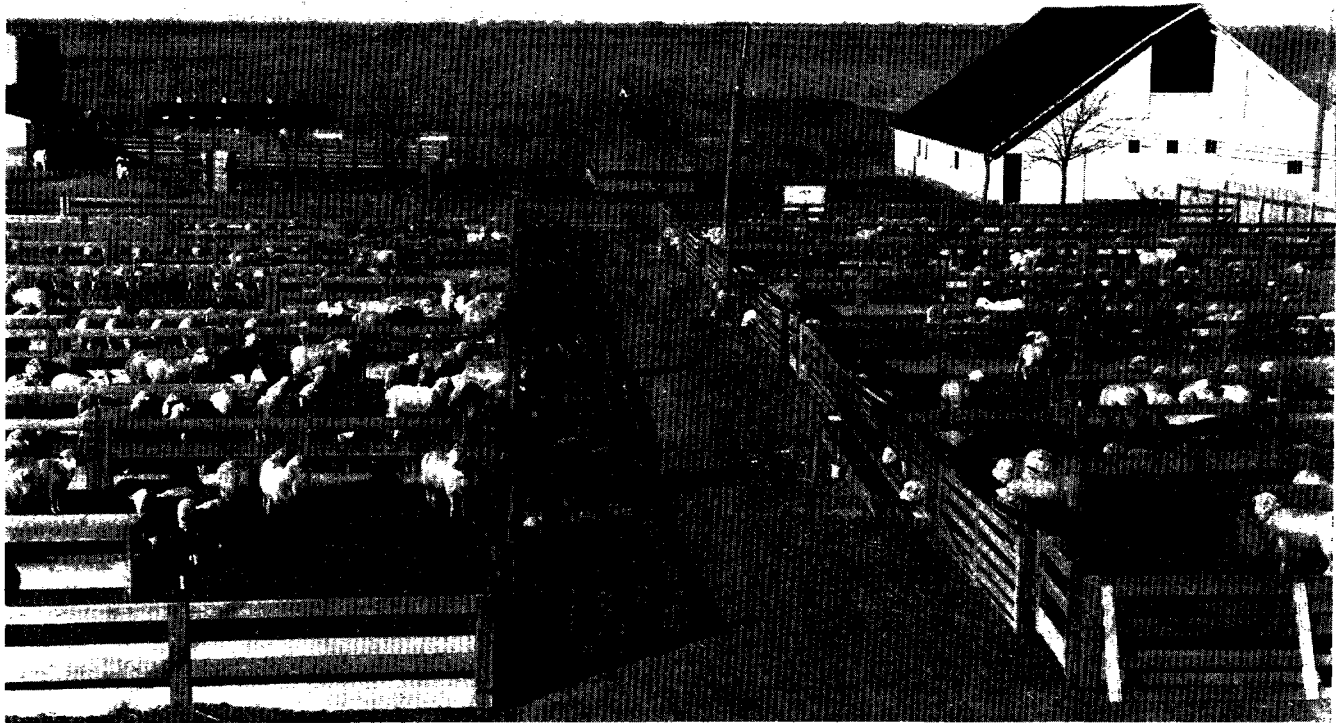

Lamb feed lots at the Garden City Branch of the Agricultural Experiment Station, Garden City, Kan. Experiments in the utilization of grain and forage sorghum crops for fattening lambs have been conducted here for the past seven years.

## FEEDING RANGE LAMBS

7

There have been several recent developments that have brought about a rapidly increasing interest in feeding lambs in Western Kansas. One of these developments was the discovery that range lambs will fatten chiefly or entirely on wheat pasture when the pasture is good and abundant. After the success of this economical method of fattening lambs had been demonstrated, many wheat farmers contracted with range sheep producers for lambs to be pastured in wheat fields. For three or four seasons during recent years pasturing lambs has proved to be a profitable enterprise in Western Kansas, and consequently the attention of many wheat farmers has been turned to the possibility of lamb feeding.

In many instances the lambs are removed from the wheat pasture and fed grain sorghums or other harvested feeds. Many farmers in Western Kansas produce both wheat and grain sorghums and have become interested in lamb feeding as a means of furnishing a better method of marketing the grain sorghums as well as utilizing the wheat pasture. Especially was there added interest when experiments showed that lambs could profitably utilize the roughage portion as well as the grain of the sorghums in fattening rations. This is important to Kansas farmers since great quantities of grain and forage sorghums are grown in the state and the roughage portion of these crops has little or no value unless it can be used in the immediate vicinity or on the farm where it is produced.

Along with these developments the Kansas Agricultural Experiment Station has conducted numerous lamb-feeding experiments during the past few years in an effort to develop rations composed chiefly of sorghum grain and roughage, and to derive feeding practices that can be definitely recommended. Many tests have been made, including comparisons of various proportions of grain to roughage, the value of adding ground limestone to grain sorghum rations, the relative merits of alfalfa, ground fodder and silage as roughages, deferring grain feeding for varying periods of time at the beginning of the feeding period, hand feeding versus self-feeding, and comparisons of several varieties of grain and roughage of sorghum crops.

The purpose of this bulletin is to bring together the results of these and other feeding investigations and practices, as well as information regarding the buying and marketing of feeder lambs, financing lamb feeding, avoiding excessive death losses, and other information related to the lamb-feeding industry.

## PART II

### Size, Quality and Types of Feeder Lambs

The feeds available and the method of feeding and handling lambs should determine to a large degree the size of lambs which would be advisable to feed. Other factors determining the selection are the relative availability and cost of light, medium or heavy lambs, and whether the feeding season is well advanced. The feeder may be so located that a supply of a certain type of lamb is more easily accessible than another, due to direct rail connections to range areas producing that type of lambs, or to some other factor. Personal preference also often influences feeders in the selection of feeder lambs, but the above-mentioned factors and the quality of the lambs certainly deserve first consideration. For this reason the advantages of each weight class must be considered carefully before a wise choice can be made.

#### LIGHT, MEDIUM AND HEAVY FEEDER LAMBS

It is not advisable to attempt to set a definite, inelastic scale of weights for feeder lambs since range and weather conditions, among other factors, cause considerable variation in weight from one season to another. Range feeder lambs reach the market and feed lot weighing from 40 to 75 pounds. Few lambs come to market or into feed lots weighing less than 40 pounds, and the majority of those that weigh more than 70 to 75 pounds are usually slaughtered instead of being sent to the country as feeders. Here again there is wide variation depending on the relative supply of well finished and thin lambs. If fat lambs are scarce on the market, packers often slaughter 70- to 75-pound lambs freely, while if fat lambs are plentiful all lambs in this weight range go out as feeders unless they are strictly fat.

There is no official market class specifying feeder lamb weights. Range producers, market men and lamb feeders, through common usage, accept certain weight ranges as representative. A weight classification that will be found to conform closely to the general idea held by feeders, dealers and others who handle feeder lambs is: Light feeder lambs, weighing from 40 to 55 pounds; medium weight feeder lambs, weighing from 55 to 65 pounds; and heavy feeder lambs, weighing above 65 pounds. It is common understanding that "average" feeder lambs weigh about 60 pounds, and this weight class is ordinarily the easiest to obtain. Lambs coming within the medium weight range listed undoubtedly constitute 60 percent or more of all feeder lambs reaching the market over a period of several years.

#### LIGHT FEEDER LAMBS

Many feeders regard light lambs as always being of poorer quality than medium weight lambs. This may be and is true in many cases where light lambs are merely the cull end sorted off of the main band. Light weight in feeder lambs may

## FEEDING RANGE LAMBS

result from other causes, however, and does not necessarily indicate poor type or quality.

Poor range feed at breeding time the previous fall may result in most of the ewes getting with lamb later than usual, and consequently the lambs might be a little lighter, but of good quality at weaning time. Again it may be that a late spring range and rather poor summer feed would cause the lambs to be thinner than normal at weaning time because of scanty range feed and a resulting poor milk flow from the ewes.

If the lambs are not too emaciated, they may be in ideal condition to go into a feed lot or stalk field and make unusually good and economical gains. For these reasons light lambs are not always undesirable or poorer in quality than heavier lambs.

In some instances the light feeder lamb is more desirable than the heavy lamb in the feeding program. Where, for any reason, the feeding is to be extended over a period of 120 days or longer, small lambs may be advantageous. They can and must be carried over a longer feeding period than is necessary for medium weight lambs in most instances if they are to reach the market finished and weighing within the most desirable weight range of 85 to 95 pounds. This longer period of feeding is easily possible with light lambs without their becoming too heavy for market by the time they have attained a desirable market finish.

The kind of feed available for lamb feeding and the difference in price between concentrates and roughages are important considerations in determining whether light feeder lambs should be fed in preference to heavier lambs. If there are large quantities of suitable roughage available, or if the price of roughages is abnormally low as compared to grain feeds, feeding light lambs may be more profitable than feeding heavier ones.

Light lambs should never be forced on feed hurriedly in an attempt to get rapid gains as may be done with heavier lambs. Consequently a good portion of the early part of the feeding period may be used to carry light lambs along on stalk fields or pastures, with possibly a feed of protein supplement, but little or no grain. With this method of handling lambs, feed and labor costs are low, the lambs go on feed with less death loss, and for a time, gains equal to those obtained with the use of more concentrated and more expensive feeds, can be produced. This method of feeding furnishes an outlet for many low-grade rough feeds that would otherwise have little or no value.

Since more roughage and less grain are utilized by feeding light lambs for a longer period in fattening them for market than when feeding medium or heavy lambs, and in view of the fact that light feeding lambs may usually be bought for a lower price per pound than heavier feeders, there are many feeders who, under conditions such as those listed, can well afford to consider feeding the lighter weight lambs. The fact that light feeder lambs make more eco-



nomical gains when favorable feed conditions prevail should further attract prospective feeders to them.

**MEDIUM  
FEEDER  
LAMBS**

Lamb feeders are more familiar with the medium weight class of feeder lambs weighing from 55 to 65 pounds. The majority of all range lambs fed each year come within this weight range and are more in demand by lamb feeders than are lambs of other weights. As mentioned above, feeder lambs in the 55- to 65-pound class are usually more available than are the lighter or heavier classes, because at the end of the summer grazing season when the lambs are ready to be weaned and shipped from the range, they are in medium condition if the grazing season has been near normal, so far as range feed and climatic conditions are concerned. The lambs are not too thin or emaciated to go on feed readily, nor are they so heavy that economical gains cannot be made. The feeder realizes that a good, thrifty, 60-pound lamb has reached sufficient age and size to go into the feed lot and make good gains almost from the beginning of the feeding period with less trouble from digestive disorders than lighter lambs might and usually do have. Furthermore, within the 90 to 120 days, such lambs may be placed on the market finished at the weight which is the most desired by packer-buyers.

Other major advantages in feeding medium weight lambs is that greater uniformity may be obtained in them than in lambs of other weight ranges. Medium weight lambs are more hardy than light lambs for pasturing on wheat or in sorghum fields and make more economical gains than heavy lambs.

**HEAVY  
FEEDER  
LAMBS**

Heavy feeder lambs are commonly bought on the market, taken out a short distance to the feed yards and placed on a somewhat concentrated ration with a view to marketing them after 40 to 60 days of feeding. Sometimes they are the lighter unfinished sort out of a mixed shipment of fat and feeder lambs which has been sent to the market. In this case they probably have already been on feed and are "warmed up." For this reason they can be fed and handled in an entirely different manner from the way the lighter feeder lambs must be fed. Probably the greatest difference is that they can be and usually are fed a much heavier grain allowance and correspondingly less roughage than lighter lambs. Heavy feeder lambs can, therefore, be expected to make greater daily gains than the lamb that is fed 90 to 100 days or longer.

Probably the greatest advantage in feeding heavy lambs is that they may be fattened and marketed in a comparatively short time by the feeder who has an ample supply of grain and a limited amount of roughage suitable for lamb feeding. If the opposite condition prevails, feeding heavy lambs usually cannot be recommended, as they are likely to become too heavy for market before they have attained a desirable market finish. Heavy lambs thus fed would produce more expensive gains than lighter lambs.

## FEEDING RANGE LAMBS

11

### QUALITY IN FEEDER LAMBS

In addition to consideration of size or weight factors of feeder lambs, feeders should pay attention to quality. To be of good quality, feeder lambs should conform somewhat to the following description:

First, lambs should be thrifty, alert, and show indications of general good health. They should have good backs, showing thickness

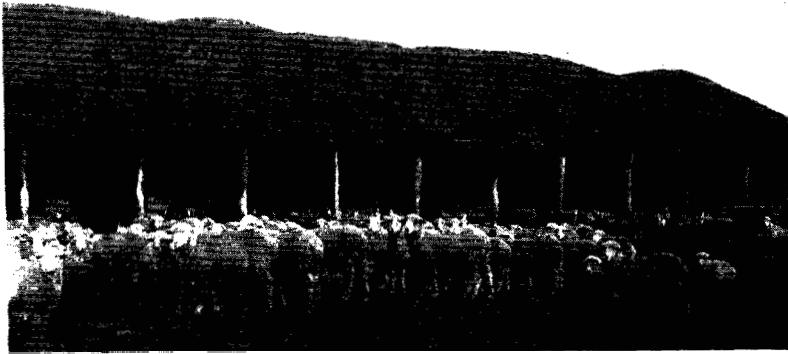

FIG. 1.—Fine-wool type feeder lambs of good quality. Note the deep bodies, good conformation, open faces and comparative smoothness. These lambs were produced on the range in Texas and are typical of the better type of Rambouillet range lamb.



FIG. 2.—Poor quality lambs. Note the angular tendencies, low back, shallow body, lean neck, droopy rump and heavy pelt of the lamb in the foreground. Compare this lamb with those illustrated in Fig. 1.

over the ribs and dock. (Fig. 1.) Lambs that are extremely angular, having drooping docks, low backs and long thin necks should be avoided. Excessive wrinkles are objectionable, and feeders and packer buyers alike pay less for "pelty" lambs. (See fig. 2.) Lambs possessing good deep middles are better feeders than shallow-bodied lambs. Feeders will also find that lambs having moderately tight fleeces will do much better than loose, open-fleeced lambs, and that an "open-faced" lamb (one whose eyes are not heavily woolled over) is more aggressive and will make better gains than those whose faces are heavily woolled down below the eyes. Lambs with heavily woolled faces should have the wool shorn from around the eyes periodically; otherwise they are "backward" feeders.

A feeder is justified in accepting low-quality feeder lambs only when the price advantage is greatly in their favor, and only then if he is prepared to handle them properly. Generally he must expect a larger death loss and be satisfied with slower, more expensive and more uneven gains, which means the lambs must be fed longer and be more carefully sorted when loaded for market.

Low-quality lambs will also sell lower on the market, and for these reasons they should be bought so the feeder will be assured of at least as much, and preferably more, margin or spread between buying and selling price than is available in lambs of better quality.

#### TYPES OF FEEDER LAMBS

Several distinct types of feeder lambs are generally recognized. Among those from the range states the chief types are commonly referred to as "fine wool," "blackface" or crossbred, and "long wool" feeder lambs.

**FINE-WOOL FEEDER LAMBS** Fine-wool lambs, as the name implies, are generally high-grade Rambouillets, although in some cases feeder lambs of Merino breeding appear on the market. Lambs of the fine-wool type are found chiefly in Texas, New Mexico, Arizona and Southern Utah, while Nevada and parts of Colorado, as well as a few other sections of the range states, furnish some lambs of this type.

Fine-wool lambs naturally do not possess as good mutton conformation as do blackface lambs. They tend to be somewhat more angular of form and lack thickness of fleshing in the leg and loin. However, such lambs, if properly sorted and of good quality, such as those illustrated in figure 1, make excellent feeders. Heavily woolled faces, excessive body wrinkles and a lack of constitution and vigor are all more common in fine wool than in other types of feeder lambs and should be avoided. This is true also of small framed lambs which are common among those of Merino breeding. They fatten slowly and it is difficult to get them to a desirable market weight economically.

Many successful feeders with wide experience feel that there are no better feeder lambs than large-frame, comparatively smooth,

open-faced Rambouillets. They are uniform, exceptionally hardy, and although they are somewhat slower feeders than blackfaces, they feed out economically and produce surprisingly good carcasses as compared to those of mutton breeding. They produce considerably more and a finer grade of wool, which is an advantage especially to the feeder who shears his lambs before marketing in the spring. The fine, dense fleece which they carry also offers considerable protection to fine-wool lambs from cold and especially wet weather. Some feeders discriminate against fine-wool feeder lambs, however, because of the prevalence of low-grade lambs among the fine-wool type.



FIG. 3.—Blackface or crossbred type feeder lambs. These lambs were produced on the range in Idaho by crossing Hampshire rams on grade Rambouillet ewes.

Fine-wool lambs are somewhat more hardy under range conditions than blackface lambs and for that reason usually come from the poorer ranges, and they are commonly thinner of flesh. Many feeders prefer high-quality fine-wool feeder lambs to blackface lambs, even disregarding the price benefit that is usually in their favor. Fine-wool lambs possess some distinct advantages that should not be overlooked.

**BLACKFACE  
FEEDER  
LAMBS**

Blackface feeder lambs usually originate in the Western Slope region of Colorado, in Idaho, Montana or other adjacent Northwestern range states. Blackface lambs are usually the result of one or more crosses of Hampshire or Suffolk rams on Rambouillet grade ewes. This type of feeder lamb is illustrated in figure 3. The mutton breeding gives them a better

conformation than fine-wool lambs possess, and they are attractive and much in demand by a large number of lamb feeders. This popularity has caused the price for blackface feeder lambs to be higher as a rule than that for fine-wool lambs.

The chief advantages of blackface lambs are that they fatten more rapidly and perhaps a little more economically than even the better grades of fine-wool lambs. Their open fleeces cause them to be somewhat more susceptible to colds produced by wet, cold weather, and they are probably otherwise a little less hardy than fine-wool lambs and therefore require more care and shelter in order to keep death losses down. Packer buyers usually exhibit the same



FIG. 4.—Corriedale feeder lambs from Oregon. Many so-called “long-wool” type lambs resemble these, while many show more pronounced evidence of their long-wool ancestry.

preference for blackface lambs that feeders do, by paying more for them fat. Usually the increased selling price of blackface lambs over good quality fine wools after they are finished is not sufficient to offset their higher cost as feeder lambs caused by their greater popularity, although in numerous cases feeders are justified in paying more for them for reasons other than that of satisfying personal preference.

**LONG-WOOL FEEDER LAMBS**

Long-wool type feeder lambs are fewer in number than those of the two types discussed above. They come to market as a rule from Oregon, Northern Utah, parts of Wyoming and to a small extent from other range sections. Long-wool type lambs usually are crosses of Lincoln, Cotswold or Romney rams on fine-wool ewes, or they may be of Corriedale breeding, as shown in figure 4. The latter is considered a medium wool breed, but lambs of this type resemble long-wool type lambs and are usually classed with them by lamb feeders.

Long-wool feeder lambs are larger of frame and coarser than the blackface or fine-wool types discussed above. Their long fleeces give them a large appearance, but they actually are not as much heavier than fine-wool or blackface lambs as they appear to be.

The chief advantage that long-wool lambs have over other types is that they may be fed a more concentrated ration and forced for more rapid gains without danger of heavy death losses from over-feeding. Long-wool lambs usually finish at a heavier weight, however, and often are docked in price for that reason.

Navajo lambs frequently appear on the feeder markets at Denver, Kansas City, and to a limited extent at other markets. They are sheep bred on the Indian reservations in New Mexico and Arizona.

**NAVAJO LAMBS** Lambs of strictly Navajo type are of nondescript breeding, sparely built, small of frame, and have open fleeces. They are of nervous temperament and do not fatten readily. This type



FIG. 5.—Indian lambs from Northwestern New Mexico, showing considerable Navajo breeding. These lambs are aggressive feeders and yield an excellent carcass if they do not run too strongly to Navajo breeding. The lambs shown here are considered excellent feeders of this type.

of lamb is extremely hardy, however, and they are aggressive feeders. Furthermore, some Navajo blood in lambs of improved breeding results in a trim, attractive carcass, and many experienced feeders seek feeder lambs of this type. (See fig. 5.) Care should be exercised to avoid those lambs with too much Navajo breeding that are consequently extremely light-boned, four-horned and with loose, open fleeces.

**NATIVE FEEDER LAMBS** Native feeder lambs are not usually available in large numbers. They are produced in farm flocks and usually possess mutton-type breeding to a great extent. Since farm-flock lambs are usually fattened and sold early in the spring

or summer, native feeders are too often late, cull, or wormy lambs which could not be marketed early. It is usually difficult to obtain any considerable number of native feeder lambs of like breeding, size and condition, and they are therefore not uniform. They are for these reasons inferior to Western lambs as feeders. Occasionally a late bunch of native lambs that are uniform, thrifty, and of good type can be obtained. If they are wormed before being put on feed, and properly handled, they are often quite satisfactory.



## PART III

### Obtaining Feeder Lambs

Lamb feeders are confronted with several important problems with regard to obtaining feeder lambs, and these problems should receive attention before the time arrives to receive the lambs. First, the feeder must determine the number of lambs he can handle with his equipment, pasturage, feedstuffs, capital, etc. Selection of the lamb markets and the method of buying lambs are other problems. Some feeders make their selections out on the ranges while others go to the larger markets. In recent years there have been many differences of opinion as to the relative advantages of buying lambs outright or contracting them. These problems are of sufficient importance to deserve further discussion.

#### NUMBER OF LAMBS TO FEED

Available feedstuffs and equipment largely determine the number of lambs that can be handled efficiently and economically. From two to three bushels of corn, or the equivalent of that amount in other grain, and from 150 to 200 pounds of alfalfa hay or its equivalent will be required to fatten an average 60-pound lamb. The amounts of feed will vary, depending upon the quality of the lambs to be fed, weather conditions, the quality of the feed to be used, and whether a protein supplement is to be included in the ration. Occasionally a feeder may purchase much of the necessary grain or roughage or both to feed out a bunch of lambs. In such instances, factors other than feeds will, no doubt, determine the number of lambs to be fed. For the average country lamb feeder, however, the aim should be to utilize home-grown feeds as much as possible and to avoid buying high-priced feeds in large quantities. If grain is the limiting factor, which it often is with Central and Western Kansas feeders, it may be advisable to buy some grain and feed a larger number of lambs in order to utilize all of the rough feeds such as fodder, stover or hay produced on the farm. This class of feeds is usually not readily marketable. If the grain sorghum grower has a minimum of 1,200 to 1,500 pounds of grain for each ton of good stover or other roughage available, he will be able to fatten lambs satisfactorily without buying feeds other than comparatively small amounts of protein supplement and ground limestone.

It is often wise to plan the crops with the method of their disposal in mind and if they are to be fed to lambs, the grain and roughage requirements should be planned so that a shortage of neither of these classes of feed will result. Otherwise it would be necessary to locate and buy enough additional grain or roughage to finish fattening the lambs. Beginning with a shortage of one class of feeds usually in-



curs unnecessary expense and may necessitate a change of feed at a critical time in the feeding period for the lambs.

It usually is more economical to feed lambs in double-deck car-load units, because of the saving on freight and other marketing charges. Some of these charges are fixed and the cost of marketing can be distributed among more lambs by loading in double-deck cars.

There are other considerations aside from financial ones, such as equipment available, which should help determine the number of lambs to buy, but undoubtedly the supply and relative prices of different feeds is one of the most important factors for Kansas feeders to consider.

Regarding labor requirements, there is great variation, depending upon the system of feeding and equipment used. In a well-planned feeding plant, two men can conveniently feed and care for from 3,000 to 4,000 lambs, and in some instances more. This ratio does not include hauling feed to the plant, however.

#### PURCHASES AND CONTRACTS

The general practice in normal times is for feeders to make outright purchases of lambs for feeding purposes. Some buy on the markets while others go directly to the range and make their own selections. Many thousands of lambs are also placed with feeders through agents or field men who operate between the range man and the feeder. Each of these methods of procuring lambs has its advantages, and conditions that prevail for each individual feeder should determine which practice he is to follow.

The chief advantage of buying directly from the range man is that usually lambs may be shipped into the feed lot and eventually on to market at a saving on freight. Buying directly from the range man usually necessitates a trip out to the range, increasing the expense of buying. In numerous instances the feeder is not able to handle the entire lamb crop of a range sheep producer, and the range man ordinarily likes to sell the whole consignment as a unit.

The selection of feeder lambs is an important part of the feeding enterprise, and unless the feeder is experienced along this line, it would be to his advantage to let a commission man or field agent who is experienced, do it for him.

Spring or summer contracts for future delivery often are made between the feeder and grower or agent. The majority of range lambs are ready for delivery usually during October. However, if crop conditions make it desirable to receive lambs at other times, they can be delivered at earlier or later dates. These contracts should always specify the minimum weight and the grade of lambs to be delivered, as well as the date and place of delivery and the method of weighing.

## PRODUCER-FEEDER CONTRACTS

Many new types of feeding contracts were developed throughout the feeding seasons of 1930-'31 and 1931-'32 because of credit restrictions, the uncertainty of general business conditions and the unwillingness to invest money in feeder lambs.

A common feature of the many different contracts was that the range man bore a part of the financial risk of the feeding operations. The "weight gain" basis was employed in many contracts and provided that the range producer should pay the feeder a definite agreed price per pound of gain in weight on the lambs. The range producer assumed practically the entire responsibility for death loss, market declines or any other risks except that of an increase in the cost of feedstuffs.

In some respects it would seem unfair to the producer of feeder livestock to require him to take a large share or all of the risk of the feeding operation as well, after he has gone to the expense and work of producing a needed commodity. Regardless of the ethical aspects of the question, however, the producer has no choice in times of credit restrictions. It must be borne in mind that the producer of feeder livestock and the farmer who produces surplus feed crops are dependent on each other to a great extent for their prosperity, and while feeders can temporarily discontinue their feeding operations and dispose of their feeds, the range producer is absolutely dependent on surplus feeds in order to create a satisfactory market for the livestock he is equipped to produce.

When it is not possible to buy lambs outright, a carefully planned contract that is fair to both parties is the logical alternative. A few of those contracts which have been widely used in Kansas and elsewhere are discussed below. It is not suggested that any one of these contracts will fit all conditions, but the different forms are listed as approximate guides for the convenience of feeders and producers who might wish to work out a form of contract to fit their own particular needs.

"Weight-Gain" Basis.—The range producer weighs the lambs to the feeder after a 12-hour shrink (off feed and water) at the range loading point. The lambs are then shipped to the feed lots, the producer usually paying the freight. The feeder feeds the lambs until they have reached specified weight, usually 90 to 95 pounds, or for a definite period of time, the duration of which depends largely on the original weight of the lambs. For his feed and labor the feeder receives a previously agreed upon price per pound of gain made by the lambs. For the past few feeding seasons this price has varied widely in different feeding sections, depending upon the prices of grain, hay and other feeds used, as well as lamb prices.

Lambs are usually sorted out in carload lots at intervals as they reach a marketable weight and finish. The sorting may be done by the owner or his agent who usually works in cooperation with the feeder. When the fat lambs are sorted in preparation for marketing,

the feeder weighs them back to the owner at the feed-lot shipping point, following a 12-hour shrink. The freight on the lambs from the feed-lot to market is usually paid by the owner, but sometimes the freight on the weight added due to feeding is paid jointly by the owner and feeder.

The death loss is borne in some cases by the owner, but more frequently by the feeder, or jointly by the owner and the feeder, with an understanding that the owner will pay for the death loss up to two percent or some other figure designated as a "normal" death loss.

The question of who is to pay the freight to market and stand the death loss is one that should be clearly understood in advance of the feeding. Death loss may be, and frequently is, a major consideration, and if either the feeder or owner of the lambs is to bear the entire risk, he should be remunerated by setting the contract feeding price accordingly.

**Joint-investment Contract.**— The feeder and the owner agree upon the price of the feeds plus the labor cost of preparing and feeding them and upon the price of the lambs. After the lambs are fattened and sold, returns are divided on the basis of the percentage of total investment held by each party. In this particular contract the freight charges, death loss and other costs are prorated in the same manner. This form is probably the fairest form of contract for both parties concerned, the only difficult feature in some cases is that of agreeing upon just what is a fair value for the lambs on the range, and for the different feeds to be used.

**Market Price Agreement.**— In this type of contract the lambs are weighed to the feeder at the range loading point as in the first-mentioned form, and he receives as compensation for his feed, labor and care, the market price per pound for which the lambs sell when fat, for each pound of gain he puts on the lamb. The grower then gets the market price for the original weight of the lambs at the range loading point. It is customary in this contract for the grower to pay freight on the original weight from the range to the feed lot and from feed lot to market, while the feeder pays freight from the feed lot to market on the gain in weight which he produces. Death loss is usually shared in some proportion by both parties to this contract.

A somewhat modified form of this agreement is that in which the feeder pays the grower for the lambs when they are sold, the amount being determined by subtracting a specified amount, usually one cent per pound, for a shrink and death loss allowance, and multiplying the remaining price by the gain in weight of the lambs.

This form of contract has the advantage of causing both the feeder and grower to share in market advances or declines.

The essential features of all of these forms of contracts are similar. There are many details not mentioned in the above discussion that must be worked out between the two contracting parties. For ex-

ample, such details as the following should be included in the contract: The quality and minimum weight of the lambs delivered, a statement that lambs will be weighed with fleeces dry, an agreement as to the place of marketing and the written consent of the mortgagor releasing for purposes stated in the contract any feed or lambs which may be mortgaged. It should be remembered that the purpose of such contracts as these is to furnish growers a market for their feeder lambs when feeders are unable to buy them, and to furnish feeders lambs through which their feed can be marketed to better advantage. Contract feeding is ordinarily extensively practiced only in times of credit restrictions and uncertain market trends. It is also under these conditions that feeders are unable to bear all of the risks of extensive feeding operations, and for these reasons, the feeding contracts often may serve a useful purpose for both the range producer and the feeder.

## PART IV Equipment for Lamb Feeding

### BUILDINGS AND SHELTER

Feeder lambs are able to withstand extremely low temperatures provided they are not exposed to too much wet weather. The need for overhead shelter depends largely on the climate in the section of the country where the feeding is done. In the Corn Belt, feeding sections, especially the eastern part, it is customary to provide large barns or sheds to house both the lambs and the feed from wet weather and heavy snows.

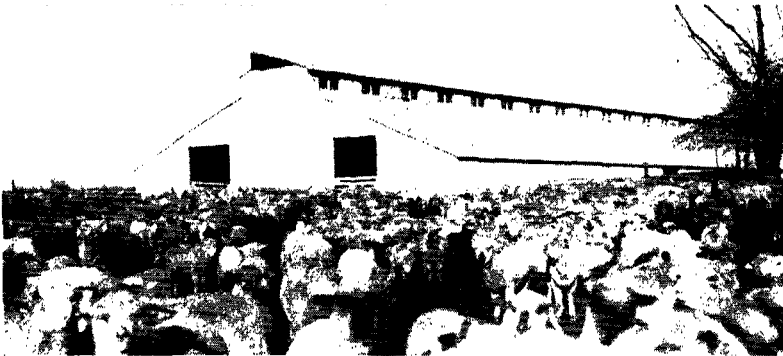

FIG. 6.—Large lamb-feeding barn with capacity of approximately 4,000 lambs. This type of shelter is needed only in sections where autumn and winter rain and snowfall are excessive.

In the feeding sections of the Western states, where the winters are dry, housing is unnecessary and feeding is done in open yards. Kansas, located about midway between these sections of the country, has climatic conditions similar to that of both the regions mentioned and, consequently, feeding is done by both methods in different sections of the state. There is little of the strictly “barn-feeding” system in Kansas, but in approximately the eastern one-third of the state, where there generally is considerable fall and winter moisture, either barns or sheds should be provided to keep the feed dry and shelter the lambs. It is not advisable, however, to confine lambs to buildings as they will usually eat more and make better gains if they have an outside run.

A fine, large lamb-feeding barn, located in north-central Kansas is shown in figure 6. This barn, approximately 80 feet wide by 225 feet long, houses the combination grain and hay feeders used. The lambs feed inside and have the run of an outdoor lot, in all but the

worst weather. Throughout the entire length of the barn is a space in the center where feed is stored convenient to the feed racks. The space on either side of the center is divided into a series of pens so that not too many lambs are kept in one pen. This feeder uses two such barns, each of which will house from 3,500 to 4,000 lambs. Buildings of this or similar type are common in the eastern Corn Belt and are almost necessary, but are perhaps more elaborate than necessary for most Kansas conditions.

Figures 7 and 8 illustrate types of lamb-feeding sheds that are frequently used. A simple, inexpensive open-front shed, facing south



FIG. 7.—An open-front shed affording protection overhead and also from north and west winds. This shed, which has capacity for 3,500 to 4,000 lambs, is of an inexpensive yet adequate type.

or preferably southeast, will serve to keep the lambs and feed dry under Kansas conditions, and is recommended for those sections of the state where shelter is needed. The homemade shed shown in figure 1 cost little to build excepting the labor required. Sheds should be of sufficient depth from front to rear to prevent rain and snow blowing into the back. Sheds less than 16 to 20 feet deep will likely be too shallow. If a shed is longer than 60 to 70 feet, partitions will be found helpful in preventing cold drafts. Poorly ventilated buildings become steamy and damp when many lambs are housed in them and lambs become "stale" and do not respond readily to feeding. Their use is to be discouraged.

Four to five square feet of barn or shed space will be sufficient for each lamb.

### FEED LOTS AND LOCATION

An ideal location for a lamb-feeding lot is a south sandy slope. It is equally as important to keep lambs reasonably dry from below as from above. South slopes are preferable because they dry quicker and afford some protection from cold north winds, but any slope is



FIG. 8.—Lamb shed in a western Kansas feed lot. Note the outdoor lights which are used at night to encourage lambs to spend more time at the feeders.

better than a level and poorly drained feed lot. (See fig. 9.) Lots that are low, flat or poorly drained become muddy quickly when lambs are trampling them after a rain or a melting snow. Lambs do not do well when they are wading in mud and when forced to bed



FIG. 9.—This open feed lot, located on a south slope, affords a clean and reasonably dry place for lambs to bed down, even during extended periods of wet weather.





FIG. 10.—A board windbreak on the north and west is the only protection afforded these lambs on feed in western Kansas. Note the thirty-six-inch panels which serve both as hay feeders and as a fence.



down in mud, take colds or pneumonia, go off feed easily, and are likely to develop digestive disorders.

The combination of a slope and sandy soil insures clean, dry bedding places through good drainage, and sandy lots can easily be plowed when they become covered with soaked manure and thus a clean surface exposed. If it is necessary to locate feed lots on flat



FIG. 11.—A large, thick grove provides fine protection to the feed lot from wind and drifting snows. Note hay conveniently placed to be fed through the combination panel fence and hay feeder. The grain pen, not visible in this picture, is located in the grove beyond the roughage lots.

places, a little grading with a scraper or grader, or plowing to a back furrow will greatly improve the drainage. Flat feed lots should be kept well bedded with straw in wet weather. The one advantage flat feed lots have over sloping lots is that it is possible to conserve much valuable manure.

#### TYPES OF FENCES

Lamb-feeding lots do not require high or expensive fencing. An ordinary woven-wire and barbed-wire fence no more than three feet in height will confine lambs. Frequently hay-feeding panels are used along the sides of the lot as illustrated in figures 10, 11 and 12, and serve the double purpose of a fence and a hay feeder. Where

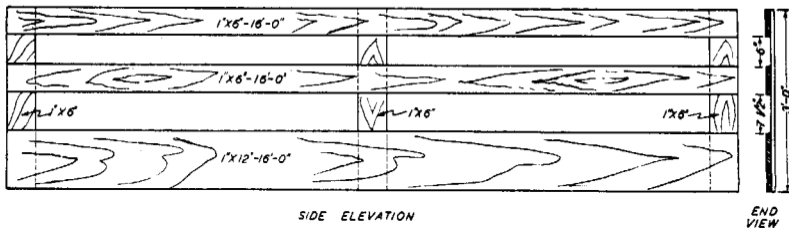

FIG. 12.—Detail of fence and feeding panel of the type illustrated in several of the feeding plants pictured in this bulletin.

open yard feeding is the practice and no natural shelter such as is shown in figure 11 is provided, it is often desirable to erect a solid fence seven feet in height (see figures 10 and 13) along the north and west sides of the lot to serve as a windbreak. Sometimes it may be necessary to erect dog-proof outside fences. (Fig. 13.) Such a fence should be five or five and one-half feet high if it is of woven-wire and barbed-wire construction. There should be a barbed wire on or immediately under the surface of the ground, to prevent dogs or coyotes from digging under, and two or more wires spaced at six-inch intervals above the woven wire. Board or tile fences should be at least seven feet high to be safe against predatory animals.

#### ARRANGEMENT AND SIZE OF FEED LOTS

The arrangement of feed lots, and the size to some extent, will depend largely on the method of feeding which is followed. Whether hand-feeding or self-feeding is followed, the lot arrangement should allow the feeding of a large number of lambs with the minimum of unnecessary work such as hauling or carrying feed long distances, and to cause as little disturbance to lambs as possible.

Usually a minimum of ten square feet of lot space should be provided per lamb. This need will vary, however, with the contour of the lot the type of soil and weather conditions. There can be too many lambs in a feed lot, even though it is a large, roomy one. Generally 500 lambs is considered about the maximum number that should be



FIG. 13.—This tile windbreak is also a dog- and coyote-proof fence.

fed together, as larger bunches are cumbersome to handle in one lot. Some feeders feed 1,000 or more in one lot successfully, however. The hay panel and grain pen system of feeding, sometimes called the "cafeteria system," is one of the most convenient ways to handle large numbers of lambs with a minimum of labor, if lots are properly arranged. The plan shown in figures 14 and 15, or some modification of it, makes an efficient feeding plant for this system of feeding.

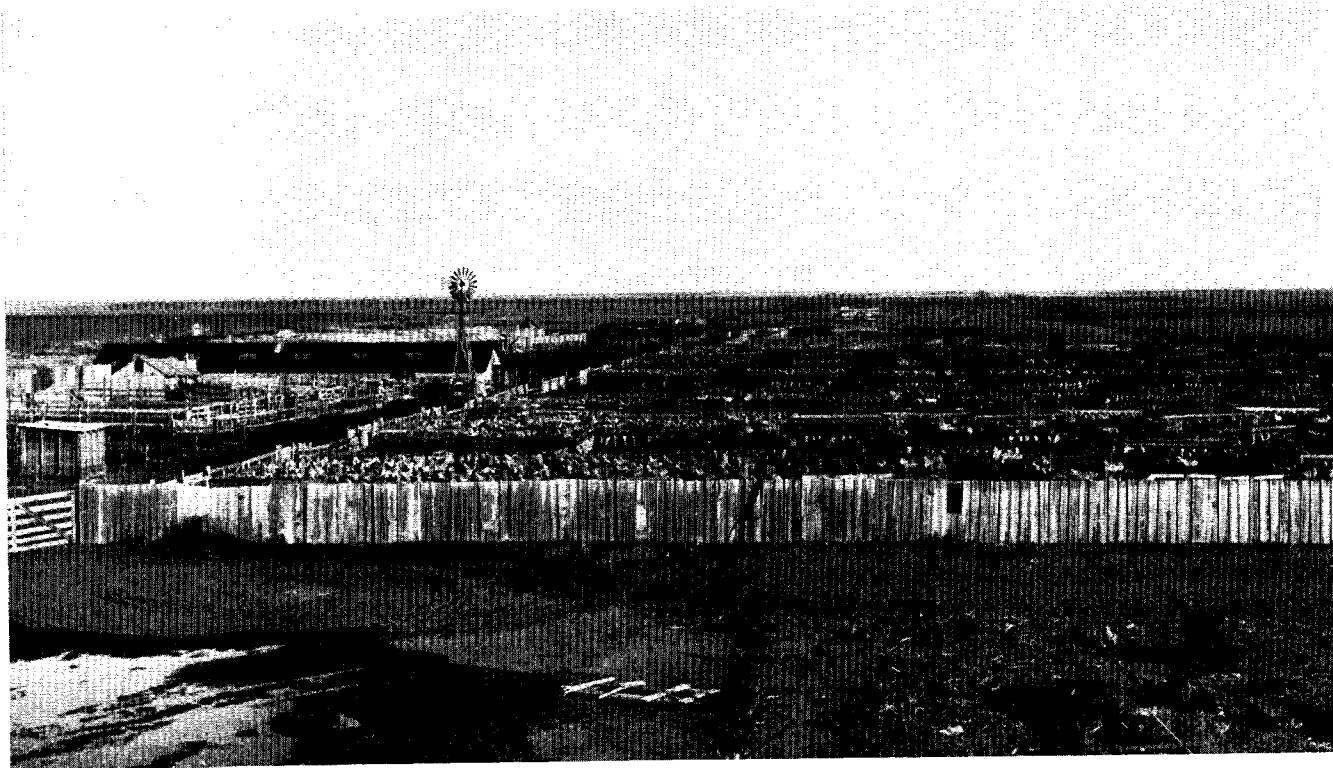

FIG. 14.—Feed lot in southwestern Kansas illustrating the panel and grain pen system of feeding lambs. The view is looking across eight holding pens, each with 1,000 lambs, where hay is fed. Note the small stacks of alfalfa conveniently placed in the offsets in the fence, where it can be thrown over against the panels as needed. Water is provided in the holding pens. The two grain pens are shown at the extreme left, one beyond the windmill. A close-up view of one of these is shown in Fig. 15.

## FEEDING RANGE LAMBS

29

In the "cafeteria" system a series of roughage lots or "holding" lots is arranged, where from 250 to 1,000 lambs are fed hay or other roughage in each lot, and where they are held all of the time except for short intervals twice daily when they are fed grain. (Fig. 14.) Roughage is usually fed through panels which are arranged in zigzag manner as a rule, in order to make feeding more convenient by decreasing the distance which the roughage must be moved by hand up to the panels. The grain pen shown at the extreme left in figure 14 and at closer range and in more detail in figure 15, is provided with enough grain troughs to accommodate the number of lambs in one holding pen.

Twice daily, occasionally three times, the proper allowance of grain is placed in the troughs, one lot of lambs turned in and allowed whatever time is required to clean up their grain, usually about 15 minutes. Some feeders follow the practice of putting out a liberal supply of grain, and timing the lambs in the grain pen, varying from 5 minutes at first to as much as 15 or perhaps 25 minutes later in the feeding period. They are then returned to their roughage lot, and grain is put in for another lot. It will be noted that the grain pen illustrated in figure 15 has the storage supply conveniently near. A small grain bin near the middle of the grain pen, or immediately to one side will save time and labor.

It is best to allow intervals of 7 or 8 feet between the rows of grain troughs, and 2 feet or more between the ends of the troughs. This allows the lambs free circulation among the feeders, which is important. Otherwise when the feed is put in the grain pen and the lambs turned in, some will have already eaten a considerable amount of grain before others have reached their places. There is a strong tendency for each lamb to feed in or about the same location in the lot each time. Usually one grain pen is provided for every four roughage lots. One or two men can conveniently feed a large number of lambs by this system, and a minimum of equipment is required. Many modifications of this system are in use, and individual circumstances and the type of feeds used will determine the particular adaptation of the system best fitted to any specific set of conditions. Other modifications of this system are shown in figures 10, 11, and 16.

Where self-feeding is practiced it will be found advantageous to arrange the self-feeders in rows with sufficient space between to allow a wagon or truck to pass, so feed can be unloaded into the feeders on either side. Unless there is more than sufficient room in the lot for the lambs, or unless plenty of help is available, it is strongly advised that an "overflow" lot be provided to put the lambs in while the wagon is driven among the self-feeders. Such a lot will pay for itself in preventing injuries to lambs. Self-feeders should be placed in the higher part of the lot, not only because it is cleaner there, but lambs like to stay on high places and probably will eat, a little more if they are induced to spend more time near the feeders.

Unless offset by other disadvantages, there is perhaps some ad-

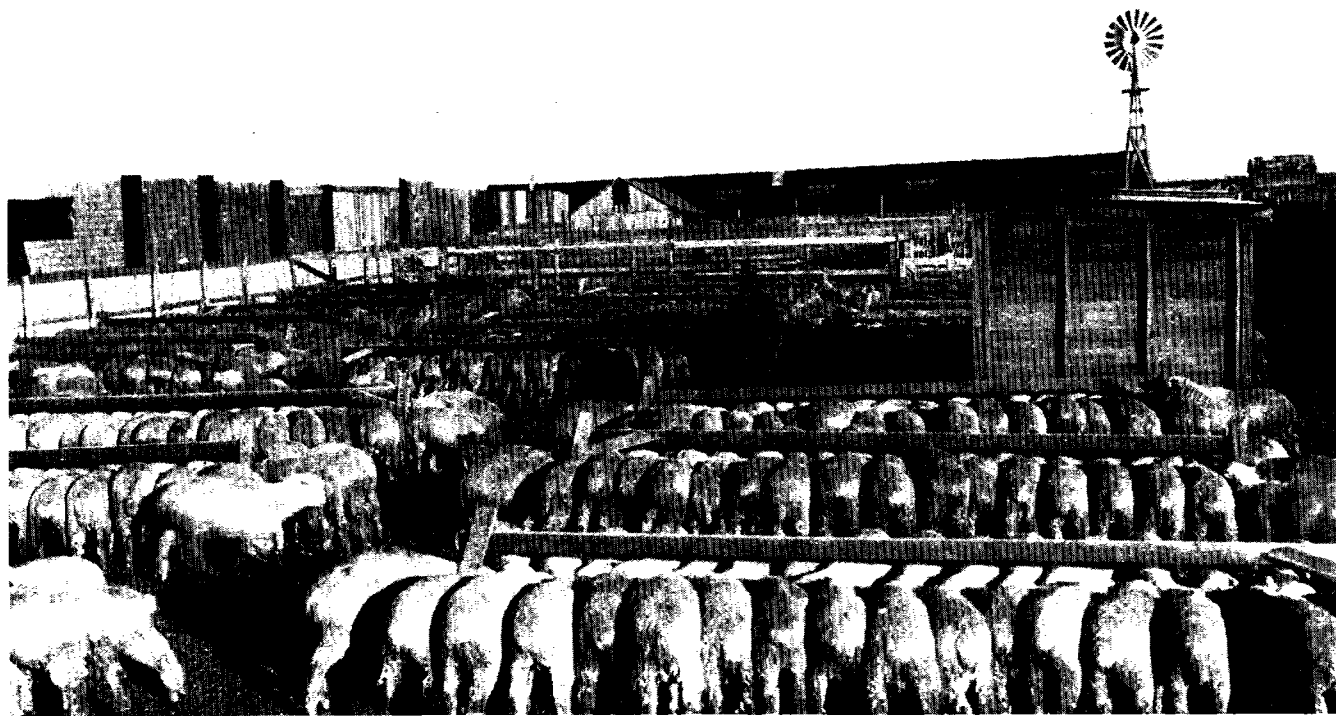

FIG. 15.—Grain pen in use with the panel system illustrated in Fig. 14. Lambs from one roughage pen or holding pen (1,000 head) feed at one time. Each grain pen serves four holding pens.

vantage to placing self-feeders north and south. There is always a small amount of moisture to collect in the feeder from the mouths of the lambs. This arrangement exposes both sides of the feeder to the sun and will help to keep the feed fresh and free from mold.



FIG. 16.—A type of hay panel and grain pen system of feeding which is often used. Lambs may be full-fed on roughage in this way with little equipment and with little waste of feed. Four such roughage pens are grouped around the grain pen which may be seen in the upper left region of the picture.

## GRAIN FEEDERS

### REVERSIBLE GRAIN TROUGH

No one type of grain feeder is best for all kinds of feeds or conditions. The reversible type of grain trough shown in figure 17, however, has many things in its favor. If one side catches snow or rain, it may be tilted over and the dry, clean side used. Or it may be left lying on its side, as shown in the illustration, during rainy weather. Figure 18 show details and construction plan for the reversible feeder illustrated in figure 17. If there are any disadvantages to this kind of feeder, one is that it is difficult to build it as strong as the single trough type illustrated in figure 19 unless it is set on end pieces which are fastened to posts set in the ground. In this case, the feeders are stationary and cannot be readily moved about. Although the reversible trough is slightly more expensive to build than the single trough, the difference in this respect is small. Feeders who have used the reversible trough feel that its advantages over the single trough far outweigh its disadvantages.

The usual length of such feeders is 16 feet. This is a convenient length, and will accommodate 32 to 35 lambs. If the sides are made of boards 10 inches wide, and the bottom is 1 inch thick, placed in the middle, this makes a trough on either side approximately  $4\frac{1}{2}$



inches deep, which is about right for most grain feeds, either whole or ground. In windy sections it is sometimes advisable to make the sides deeper. The center rail above and for the full length of the trough is necessary to keep lambs out of the feeder.

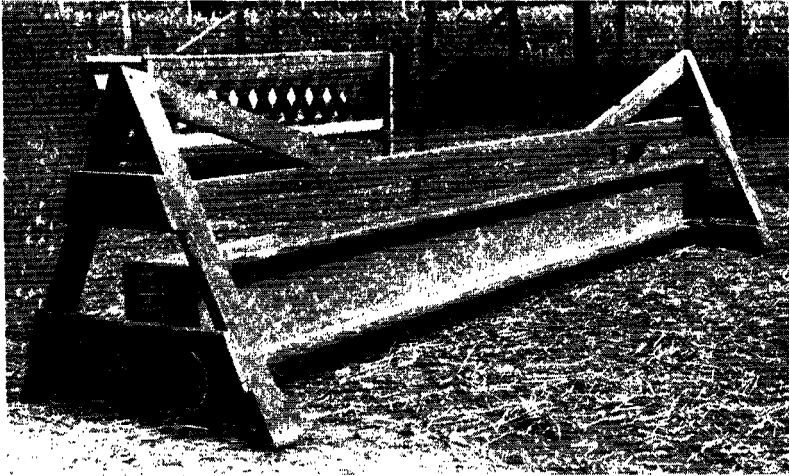

Fig. 17.—Reversible grain trough. The trough may quickly be inverted to provide a clean feeder free from rain or snow, or it may be left on edge as illustrated so no water will be caught.

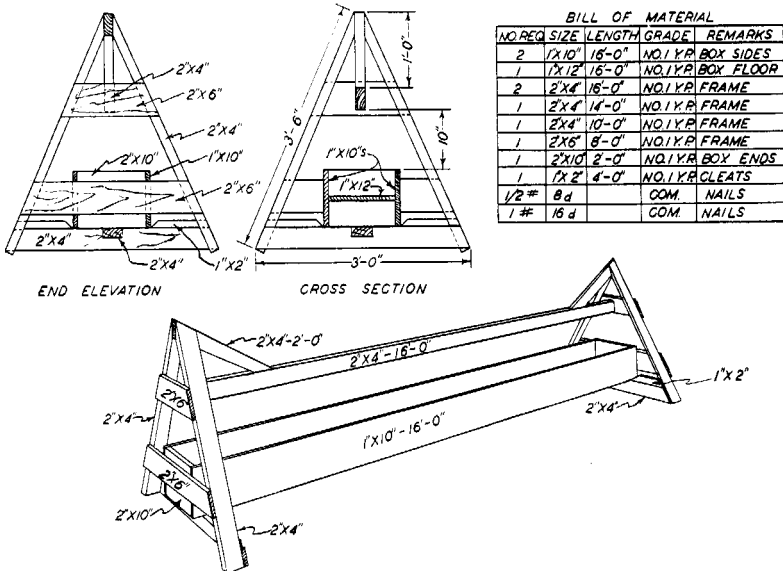

Fig. 18.—Detail and construction plan of reversible grain trough shown in figure 17.



FIG. 19.—Single trough grain feeders, situated on a sandy slope—a good arrangement for grain feeding.

## ROUGHAGE FEEDERS

### HAY PANELS

In deciding on the best type of roughage feeder to use, the primary consideration is the kind of roughage to be fed, and also the form in which it is to be fed. Climatic conditions should be considered also in determining the kind of roughage feeder that will be most suitable. In many lamb-feeding plants in the West where the feeding season is comparatively dry, hay panels such as those illustrated in figures 10, 11, 14 and 16 serve both as a fence and a roughage feeder through which lambs eat hay, sorghum fodder, beet tops, or even silage. This is an efficient way of feeding, since a large number may be fed in a small space, and in a short time with a minimum of labor. Furthermore, if done carefully, this method is not particularly wasteful of feed, even though the feeds are placed on the ground or, as is sometimes done, on clean straw. Panels have the added advantage that they can be taken down and stacked in a compact space for the 7 or 8 months of the year while they are not in use, and when the time comes to erect a new feeding plant, it can be done quickly and conveniently by setting up the panels. They may be set up on a new location if necessary, or the old feed lot may be plowed and planted during the summer if desirable. While many other types of roughage feeders have been commonly used in the past, few feeders now use a strictly roughage type feeder. The trend has been toward the use of the combination feeders.



**COMBINATION FEEDERS**

There are many kinds of combination grain and roughage feeders that serve the purpose well where many kinds of feed are fed. A common type of combination feeder is one that holds the hay in a separate compartment above, from which it is eaten through upright slats, while the grain is fed in a trough compartment below. This type is satisfactory where grain and hay are to be fed separately and when the hay or roughage is fed whole. Another type, however, which is more widely adaptable to various feeds is that illustrated in figure 20. This feeder has a trough 10 inches deep.

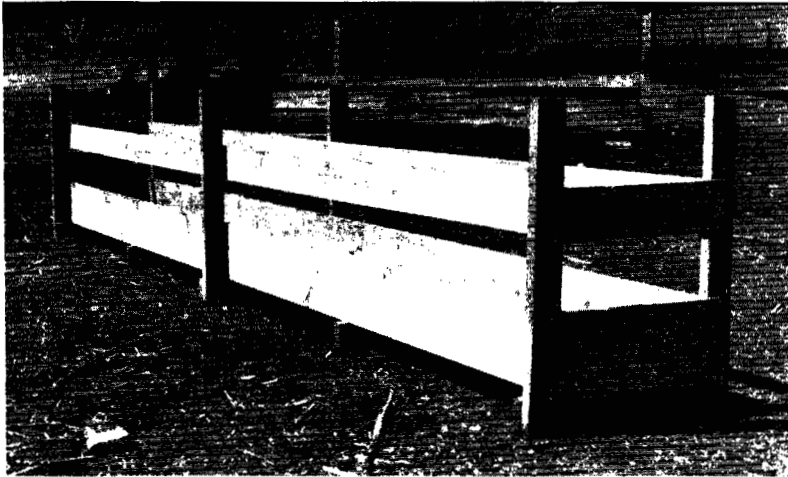

FIG. 20.—A combination type of feeder which is economical to build and which is satisfactory for whole or ground grain or roughage of any kind, fed separately or together.

Immediately above this is a 7½ or 8-inch opening through which the lambs place their heads, and above are additional boards to hold bulky feeds such as hay.

This type of feeder can be used for any kind of grain, for whole or cut roughages, or for grain and roughage ground and mixed. Such feeders as this should always be of sufficient width to allow lambs to eat from both sides without interference. (Note figure 21.) A trough 20 inches wide is the correct dimension. Thus if 1" by 10" material is used the width and depth will both be right. Figure 22 shows in detail how this feeder may be built. Occasionally 1" by 12" boards are used and this makes the trough both too wide and too deep, leaving a space in the lower corners, and one in the center where the lambs are unable to reach the feed, and it remains in the trough to mold.

**SELF-FEEDERS**

Self-feeders for lambs, such as those illustrated in figure 23 may be constructed at a low cost. No one type appears to be best suited to all feeds, and many different kinds are in common use. In any case, the self-feeders should have water-tight covers, especially if feed is not put out fresh every day. Otherwise moisture will collect, the feed will become moldy, and the result will be that some lambs are thrown off feed, and possibly some death loss may follow. It is a good plan to have the sides of the self-feeder adjustable so they can be raised or lowered and thus control the flow of feed into the trough below.

A more elaborate type of self-feeder with adjustable sides is shown in figure 24. It usually is found necessary for a caretaker to go to all the feeders several times a day and punch down the feed with a broomstick or similar device. Self-feeder troughs should be about 5 to 6 inches deep to prevent waste, and the "(throat" where the lambs eat, not more than 10 inches wide on each side, otherwise lambs will get up in them.

The amount of feeder space allowed for each lamb is an important consideration. Too little space is an inducement for some greedy lambs to overeat. A little crowding on the part of the lambs at the feeders is good insurance against overeating. Where hand-feeding is the practice followed, each lamb should have about one foot of space at the feeder. With self-feeders, a foot of feeder space for every three lambs is sufficient. If lights are provided so lambs eat at night, a foot of feeder space for four lambs or more is sufficient. The self-feeder must have frequent attention to see that the mixture is feeding down at all times.

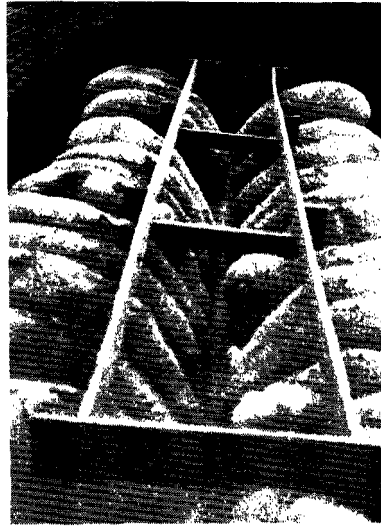

FIG. 21.—Combination feeder of correct width to permit lambs to reach all of the feed, and to prevent them pushing each other away from the trough. Note triangular molding in center which prevents leakage of finely ground material and facilitates cleaning of feeder.

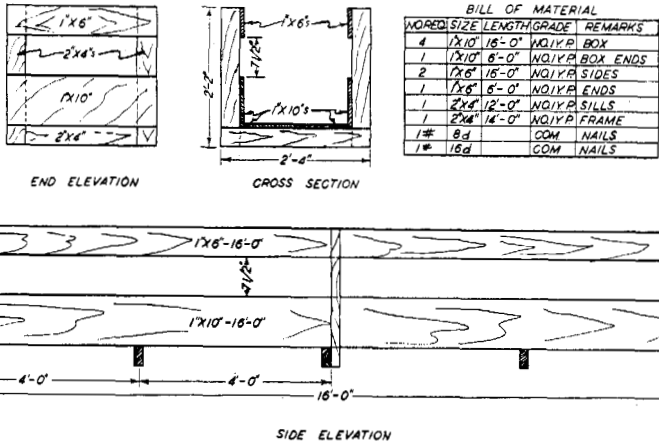

FIG. 22.—Detail drawing of combination feeder shown in figures 28 and 29.

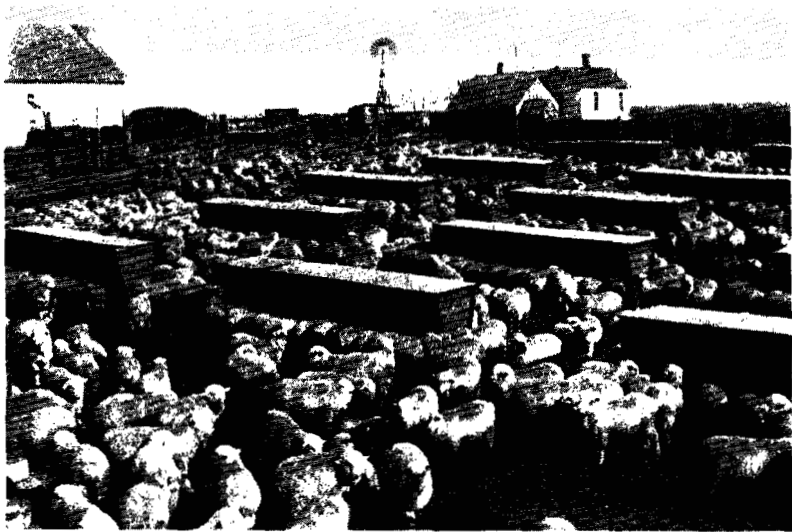

FIG. 23.—A self-feeding plant for lambs in southwestern Kansas. Notice arrangement of feeders for convenience in filling.

**WATERING DEVICES**

Watering devices should be placed some distance from the feeders if practicable. If placed near the feeders, lambs leave the feeders frequently with a mouthfull of feed to be dropped in the water trough. Figure 25 illustrates a satisfactory watering arrangement. Note the structure to keep lambs out of the trough. Every effort

should be made to supply fresh water at all times. The adage that a lamb's progress in the feed lot is in proportion to the water he drinks, is, perhaps, overstated, but it is at least largely true, and serves to emphasize the great importance of water in the lamb's

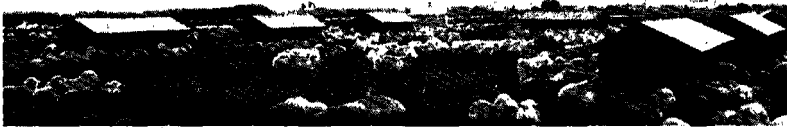

FIG. 24.—Self-feeders with adjustable sides, which may be adapted to the handling of almost any kind or combination of feeds.



FIG. 25.—A good arrangement for supplying fresh water to lambs. The structure over the tank is necessary to keep lambs out of the water.

diet. It is peculiar to the nature of a lamb that he will drink more water if he can hear it drip or trickle. This is a small thing, but if it can be arranged to allow the water to drip or run slowly most of the time, the lambs will drink more, and it will help to get them to eat more.

Facilities should be provided to keep the water from freezing in the winter. The watering troughs may be placed over pits filled with manure. An empty pit 3 or 4 feet deep under the trough will also keep the water from freezing and lambs will do much better if water, not ice, is provided in the winter. Any surplus water should be run out of the lot, as lambs do not like to wade in water or mud. Most successful feeders feel that it is well worth while to take advantage of small details of this nature. Running water is satisfactory for lambs during the winter months, but if lambs in feed lots are to be supplied with running water, panels should be run along

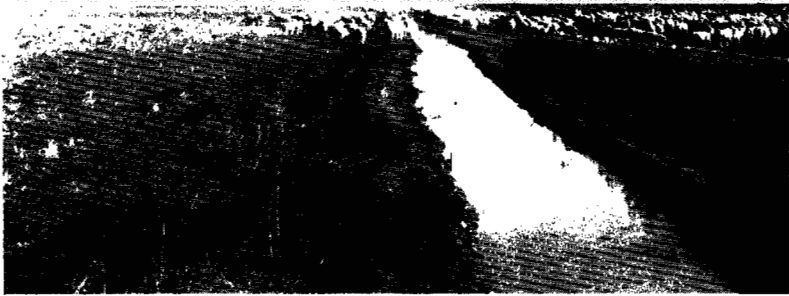

FIG. 26.—An irrigation ditch supplying fresh water to lambs pasturing in a beet field.

the stream to keep them out of it. Streams such as irrigation ditches which supply a constant source of fresh water are ideal. Figure 26 shows lambs pasturing on beet tops and watering at an irrigation ditch.

#### CUTTING CHUTE

A cutting chute built so as to be accessible to all lots is a great convenience and almost a necessity where large numbers of lambs are to be handled. It is frequently desirable to sort and divide lambs according to size, sex or condition. The chute saves much work and time as well as a great deal of running of the lambs back and forth. One of its chief uses is for sorting lambs for market. In this task, it is desirable to handle most, if not all of the lambs. By letting them walk slowly through the cutting chute this is possible and they are separated simultaneously into two lots, one ready for shipment, and the other to be continued on feed. A great saving often results with the use of a cutting chute for sorting fat lambs from those needing additional feeding.

The cutting chute should be approximately 14 inches in width at the top, for easy handling of lambs and not to exceed 16 inches under any condition. If the chute is too wide lambs attempt to go through double file or to turn around. If it is ever necessary to work lambs through the cutting chute at night, as it sometimes is, a light arranged so as to illuminate the exit of the chute and the lambs which have gone through it, is almost a necessity. It should not shine directly toward the lambs coming through.

The length of the cutting chute, to work satisfactorily, should be at least 10 feet for lambs, although it can be made 6 to 8 feet longer and two



FIG. 27.—Cutting chute being used to separate feeder lambs into heavy and light groups.

cutting gates put in it to make possible the sorting of lambs into four lots if large enough numbers are handled to justify it. The walls of the chute should be 30 inches high and it is important that they be boarded up solid, otherwise lambs will not go through it readily. The cutting gate should be about two feet wide. Figure 27 shows a cutting chute being operated to separate light and heavy feeder lambs. If the chute is built on a slope, it should be arranged so the lambs go uphill through it. No experienced sheep man would attempt to run sheep downhill through a cutting chute.

## PART V

### Feeds and Methods Used in Fattening Lambs

#### GRAIN FEEDS

**Corn.**—Corn is probably the most universally used grain for fattening lambs. When fed with alfalfa or other good legume hay, and possibly a small amount of protein supplement it is doubtful if there is a better lamb-fattening ration. In determining the value of other feeds, corn usually is the standard of comparison.

Two methods of feeding corn to lambs in the feed lot—hand-feeding and self-feeding—are in common use. When hand-fed, corn need not be ground. Lambs will eat whole shelled corn readily with little or no waste, will thoroughly grind it for themselves, and there is less likelihood of “bolting” the feed and gorging than when it is ground. Many feeders successfully feed whole ear corn to lambs. This is advisable especially when lambs have been feeding in the corn field and must be transferred to the feed lot. When they are to be full-fed in the dry lot, however, it will usually pay to shell the corn and thereby eliminate some waste and insure more uniform consumption by all the lambs. The grinding of ear corn (corn-and-cob meal) is a practice occasionally resorted to by lamb feeders and is advisable only in those cases where roughage is scarce and costly and the cobs are needed to give bulk to the ration and prevent losses due to overconsumption of grain. Otherwise the cob has little if any value and would only reduce the amount of some other feed the lambs would eat. Moreover they have a tendency, due to their binding effect, to cause impaction.

Where corn is to be self-fed to lambs, it should be not only ground moderately fine, but should also be thoroughly mixed with ground hay or other roughage. This is necessary in order to prevent the lambs picking out the grain and refusing the roughage. If corn is merely coarsely cracked, lambs soon learn to agitate the mixed feed with the nose and lips, causing the grain particles to gravitate to the bottom of the trough where they can be gathered up. Death losses have been traced to this practice in cases where the original mixture of grain and roughage was correct, but the feed was either too coarsely ground, or improperly mixed.

**Grain Sorghums.**—The grains of the leading sorghum crops such as milo, kafir, feterita and hegari are practically equal to corn for fattening lambs. Unlike other farm animals, lambs will utilize threshed sorghum grain with very little waste in the form of undigested grain. Observations of experimental tests and of feeding practices lead to the conclusion that while lambs benefit slightly in the way of larger gains from sorghum grain which has been ground, the gain is insufficient to pay the cost of grinding, unless the grain is to be self-fed with roughage. If fed in the head, grinding of grain



sorghum shows still less advantage as the stem in the heads causes lambs to chew the feed much more thoroughly before swallowing it. However, if the sorghum heads are fed in troughs and not on the ground, a considerable saving of feed can be made by grinding or chopping the entire head. This is an excellent form in which to feed sorghum grain. The heads are apparently as palatable to lambs as the threshed grain, and produce practically as much gain, which means that the stemmy portion of the head is utilized with good results by this method of feeding, or at least it increases the efficiency with which the grain is assimilated and used. If grain sorghum heads are to be fed in this form the percent of grain and stem in the heads should be determined and allowance made for stem in figuring the amount of grain consumed. Where grain sorghums can be grown more successfully or purchased cheaper than corn, there is no reason why they should not be used in the lamb-fattening ration instead of corn. Further discussion of these feeds appears later in the section dealing with the grinding of sorghum roughages.

**Wheat.**— When low in price compared with other grains, wheat often may be fed advantageously to lambs. Lambs like it better whole and ordinarily it should not be ground for them. However, if mixed with other grain, it will be found necessary to grind wheat, otherwise lambs will refuse it. Wheat is distinctly less palatable to lambs than corn or most grain sorghums, and will be more readily eaten if mixed with some of these better-liked grains. Wheat fed as the only grain has about 90 percent the gain producing value for lambs as an equal weight of corn. This is due not to its composition but to the fact that lambs do not relish it. However, by grinding and mixing it with other grains which are better liked, it may be made equal to corn in value. For this reason it is doubtful if it would pay to feed wheat as the only grain to lambs unless there existed a wide margin in price between it and other feed grains in favor of wheat, which is rather an infrequent occurrence. Shriveled wheat is more palatable to lambs than well-matured wheat.

**Barley.**— In some sections of Kansas, barley is commonly used to fatten lambs. Whole barley is eaten readily by lambs and is liked better than ground barley. Rolling or crimping is the best means of preparing it, and rolled barley will produce slightly larger gains than whole barley, but usually not enough to justify the cost of rolling. Barley is worth approximately 85 percent to 90 percent of the value of corn of the same grade, pound for pound, in producing gains on lambs.

Lambs may be put on full feed somewhat faster when barley is fed than with corn and without so much danger of abnormal death loss, because of the more bulky nature of barley.

**Oats.**— It is not often that oats are used as the only grain for fattening range lambs in Kansas. Ordinarily they are a higher priced grain than corn, grain sorghums, or barley for fattening lambs in Kansas, and particularly so when the finish and rate of gain pro-



duced by oats is compared to that produced by other kinds of grain more commonly used. Oats will produce gain in weight on lambs about as fast as corn during the early part of the feeding period, but for the entire fattening period are only about 75 percent as efficient as corn in producing gains and finish. Lambs show more of a tendency to grow rather than to fatten, if oats entirely replace other grain in the ration. Oats have a high value in getting lambs on a full feed of grain. Because of their bulky nature they are a much safer feed than the more concentrated grains during the early part of the fattening period. If oats are to be used for fattening lambs, it would probably be more satisfactory to use them until the lambs are on full feed, and possibly for the first half of the fattening period, then gradually change over to corn or other grain, taking ten days to complete the transfer. This would probably be a better plan than to feed a grain mixture including oats for the entire fattening period.

#### SUGAR BEET BY-PRODUCT CONCENTRATES

In the Arkansas River valley of Southwestern Kansas, sugar beets constitute a crop of increasing importance. As has been the case in the adjacent section of Colorado, and in other older beet-growing sections, lamb feeding appears to be developing with the sugar-beet industry. This is true partly because the by-products from beet sugar manufacture are all excellent lamb-fattening feeds. It is unquestionably more economical to use such by-products as near the factory as possible because of the difficulty and high cost of transporting and storing them. Furthermore the fertility returned to the soil as a result of lamb feeding is an important consideration, especially where sugar beets are grown in an irrigated section. There is no question as to the soundness of expanding lamb feeding in that particular part of Kansas, at least to the extent that all beet by-products will be consumed locally.

**Beet Molasses.**—Beet molasses is fed to lambs by two general methods—with grain and cut roughage mixtures and self-fed in tanks or troughs. Its efficiency is greater when fed by the former method and in limited amounts. Its value has been established by numerous experiments at from 80 percent to 90 percent that of an equal weight of corn. Under some conditions it would vary over a wider range. Its greatest value is realized when fed in amounts not exceeding one-fourth to one-third of a pound per lamb daily, together with grain, when it may equal or even exceed in value the grain it replaces. On the other hand, it may have no more than 65 percent to 70 percent the value of corn if fed in large quantities, thus replacing most or all of the grain in the ration.

Beet molasses also varies with the method of manufacturing it or the extent to which the sugar is removed. It is appetizing to lambs and has some value as a means of inducing greater consumption of unpalatable feeds. Furthermore, beet molasses is laxative and many experienced feeders are familiar with the fact that a larger total

consumption of concentrates by lambs can be obtained when beet molasses is included in the ration than can be safely obtained with grain alone.

Facilities for mixing molasses evenly with grain or cut roughages are not available on many farms. In experiments with its use at the Garden City Branch Experiment Station, after weighing or measuring the proper allowance, the molasses was poured in a "ribbon" in the bottom of the trough and grain and ground grain sorghum fodder put on top of it. This method of feeding proved entirely satisfactory and can be recommended. The lambs do not get molasses smeared over their heads, and in warm weather, flies are less troublesome than where molasses is exposed all the time. Some feeders are following the practice of mixing molasses with the drinking water, and report good results are obtained in inducing lambs to drink more water. This has not been checked experimentally and no definite information is available on the practice. Because of its high content of alkaline salts, making it a laxative feed, beet molasses must be fed in small amounts at first and lambs must become accustomed to it gradually. Many feeders are under the false impression that molasses will take the place of protein supplement in the ration. It must be remembered that molasses has little or no protein and, when used, it becomes even more urgent that the protein requirements be met by the use of some good feed rich in protein.

**Beet Pulp.**—Beet pulp is ordinarily fed to lambs as wet beet pulp or pressed beet pulp, although it is sometimes mixed with molasses and fed as dried molasses beet pulp. Dried beet pulp fed either with or without molasses is sometimes credited with being equal in value to corn. Experiments have proved that, like molasses, beet pulp may equal or surpass in value the grain it replaces, if fed with grain and if it does not exceed 50 percent to 60 percent of the entire concentrate allowance. Fed as the only concentrate without grain, its value is much lower. Wet beet pulp contains about 85 percent water as a rule, while dried beet pulp contains only about 10 percent water. Therefore five to six pounds of wet beet pulp are required to replace one pound of dry pulp or grain. Near beet sugar factories, wet beet pulp can be used in the lamb-fattening ration and will reduce the grain and roughage requirements, and keep down digestive trouble caused by too concentrated mixtures. It is extremely palatable to lambs and helps to keep the digestive system in order. Because of the high water content, wet beet pulp spoils readily and therefore it should be ensiled unless it can be hauled fresh from the factory to the feed lot every day.

### ROUGHAGES

**Alfalfa.**—In established lamb-feeding sections, especially in the West and Middle West, alfalfa hay is considered a standard roughage for lamb-fattening rations. When fed in proper balance with grain, alfalfa is unexcelled by any roughage for lambs. In sections where alfalfa is plentiful, it is commonly full-fed with grain at the

rate of 2 to 2½ pounds per lamb daily, or by allowing the lambs access to it all the time, while the grain is more or less limited. On the other hand, where alfalfa is scarce and grain is relatively low in price, alfalfa is sometimes limited to 1 pound to 1½ pounds per head daily and the grain allowance raised accordingly. The first method is safer, but both produce excellent results and the relative price of grain, alfalfa and other roughages should determine the extent to which alfalfa is fed.

Lambs do not require fine-stemmed leafy hay, although they prefer it and eat it more completely. The coarser stemmed first cutting hay is nutritious and satisfactory for fattening lambs. It may be necessary to force the lambs to eat most of the stems by leaving them in the feeder and possibly by reducing the feed slightly, but when this is done good results are obtained from it. Lambs should always be forced to eat these coarser particles unless good hay is abnormally low in price or unless heavy feed consumption and rapid gains are sought, even at the greater expense necessary to obtain them. Large quantities of moldy or musty alfalfa should not be fed to lambs. This is poor economy and may result in death losses. Brown and stack-burned alfalfa are apparently as palatable as green hay to lambs and they are excellent roughages for use in lamb-fattening rations, although somewhat lower in nutritive value than green alfalfa.

Usually good quality alfalfa hay is fed whole, although some feeders prefer to grind it. The main object in grinding should be to prevent waste of hay, and with good feeding practices this is usually not enough to pay the cost of grinding. Equal gains are produced on lambs with whole hay and with ground hay. When self-feeding of grain and hay is followed, it is necessary to grind both and mix them well to insure a balanced consumption of grain and roughage.

**Grain and Forage Sorghum Roughages.**—In recent years farmers have been giving attention to methods of fattening lambs whereby ground sorghum fodder is fed as the major part or all of the roughage allowance. The development of the hammer mill and other types of mills that will successfully grind coarse roughages has opened increased possibilities to the farmers in the grain sorghum producing regions. While it is true that ground sorghum fodder is less palatable and nutritious than alfalfa hay, it is also true that by proper preparation and use it can be made a highly satisfactory roughage in the lamb-fattening ration. The advantages to Plains farmers of using this type of feed which otherwise would have low market value, are numerous and are so obvious that a discussion of the subject is unnecessary.

Grinding of fodder is not necessary in order to get good gains. If fed whole, however, only the leaves and finer particles will be eaten as a rule, while most of the stalk, representing far the greater part by weight of the fodder, will be refused. Few feeders have sufficient feed to afford this waste, and therefore grinding of sorghum fodder

and stover usually pays, not because of any improvement in its nutritional value, but because of the thoroughness with which it can be utilized.

The high moisture content of fodder in the fall and early winter makes its storage somewhat of a problem. It is usually necessary to grind daily or at two-day intervals in warmer weather and every four to five days in very cold weather unless facilities are available for spreading the ground feed out thin. This is not a serious handicap, especially where as many as two or three carloads or more of



FIG. 28.—Equipment for grinding or chopping and storing inside, sorghum fodder or stover. Rough weather interferes but little with feed preparation with this equipment if a reserve supply of feed is stacked nearby.

lambs are fed. Sorghums are usually hauled in from shocks in the field as needed for grinding. For that reason a reserve supply sufficient to last several days should be stacked near the grinder for use when mud or snowdrifts make hauling difficult or impossible. Otherwise the sudden change in types of feed which would be necessary during such times probably would upset the lambs. Figure 28 shows a hammer mill, silage cutter and electric motor situated where grinding may be done and the ground feed stored inside. This arrangement greatly increases the convenience of handling ground feed during periods of bad weather.

Figure 29 illustrates another method for handling sorghum roughages used by Kansas feeders. A simple overhead bin is constructed

and the hammer mill arranged to blow the ground feed into it. A truck or wagon can be backed under the sheltered area below the bin and loaded from a trap door quickly and with no interference from the wind blowing the feed out.

Still another arrangement used with a high degree of success consists of grinding the roughage into an elevated bin in the feeding shed. An overhead feed carrier on a track is filled from the bin and may be pushed along the track to where it is needed and there dumped into one of a row of feeders placed immediately under the

track. While these methods add greatly to the convenience and economy of grinding and feeding sorghum roughages, still they are not absolutely essential and many feeders successfully grind and feed sorghum roughages entirely in the open and with no special equipment for handling.

Chopping sorghum roughages with a silage cutter is a fairly satisfactory, but not equal, substitute for grinding. Feeders who have inquired in regard to this practice have been advised that one method of preparation was as good as the other. However, experiments and observations have established the fact that grinding increases the palatability



FIG. 29—A convenient method of grinding and feeding sorghum roughages. The feed is blown from the hammer mill into an elevated bin. Trucks or wagons are loaded from a trap door in the sheltered area where the wind does not interfere and waste feed.

of the roughage, and results in increased consumption. This is probably due to the fact that the feed is more or less shredded and the moisture and sugar are more evenly distributed through it. Lambs refuse and waste more of the chopped feed and show somewhat less relish for it. Figure 30 illustrates the difference in texture between ground and chopped sorghum roughage.

When grain or forage sorghum fodder is cured with fine stalks, however, it may be fed whole with little waste. Figure 31 illustrates a Southwestern Kansas feeding plant where lambs are fed whole Atlas fodder grown thick under irrigation, and the amount wasted was negligible as may be seen around the panels.

The feeding value of forage and grain sorghum fodders alike, varies widely with the fineness or coarseness of the stalk, its ma-

turity, and its leafiness. While it is not invariably true, still there is a strong tendency for the feeding value of these fodders: to vary directly with their palatability. More cottonseed meal or other protein supplement should be fed where fodder is used as roughage, than where alfalfa is fed. Experiments at this and other stations have also shown that where ground sorghum roughage is fed, one-fourth ounce of ground limestone per lamb daily is decidedly effective in producing increased gains if no alfalfa is fed. Thus in order to make ground sorghum fodder approach the feeding value of alfalfa, careful attention must be given to correcting both its protein and calcium (lime) deficiencies. Large quantities of moldy or otherwise spoiled

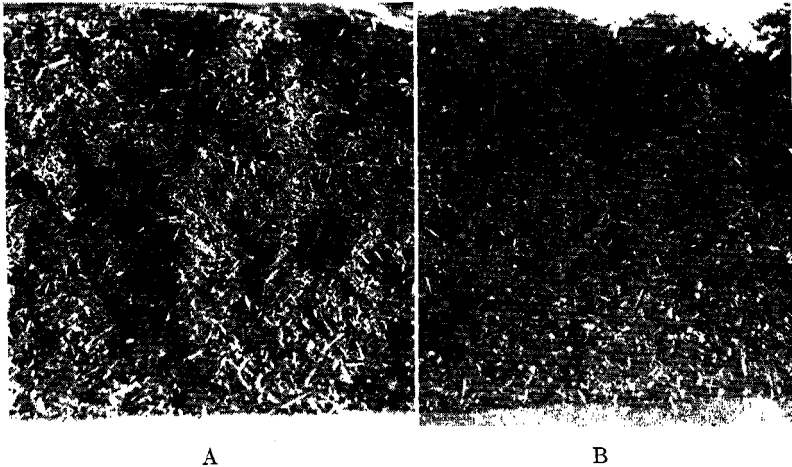

FIG. 30A.—Ground sorghum roughage showing uniformity of texture characteristic of this method of preparation.

FIG. 30B.—Sorghum roughage chopped with silage cutter, resulting in a somewhat less homogeneous mixture than when ground. The coarser, drier particles are refused by lambs.

fodder should not be fed to lambs. If sorghum fodder (grain on) is fed to lambs, the amount of grain it contains should be carefully estimated and allowance made for it in grain feeding. Several cases of abnormally high death losses have been observed when feeders fed lambs a full-feed of grain and fed fodder for roughage, without considering the fact that the fodder itself may be about 40 percent grain by weight. Grain and roughage proportions in fodder feeding may be adjusted in several ways. It is unsafe to allow lambs a full feed of fodder containing as much as 30 percent grain or more, when they are first going on feed. To avoid this and still full-feed on roughage, a good plan is to top every third bundle or perhaps more of them, depending on the grain content, as the fodder is ground. The heads thus removed may be added to the fodder later

in the feeding period when it is desirable to increase the concentration of the ration.

In this connection, attention is directed to the deferred grain feeding method tested by the Kansas Agricultural Experiment Station. In a series of several tests the usual practice of full-feeding of grain from early in the feeding period was compared with that of withholding a large part or all of the grain for varying periods of time in the first part of the feeding period. After tests were run on numerous phases of this method, and since they have been repeated a number of times for checking results, it has been definitely established that the practice of full-feeding lambs on roughage and with-



FIG. 31.—Whole Atlas fodder fed through panels, with little or no waste. This feed was grown thick, under irrigation, and was unusually fine stalked. Note the feed supply stacked in long ricks on the north and west sides of the feed lot for protection from storms.

holding the major part of the grain for approximately one-third of the feeding period results in as good gains and finish as where they are full-fed grain from the beginning. The gains thus produced are cheaper, since this practice results in a saving of grain and increased utilization of low-priced roughages. Another major advantage of deferred grain feeding is that lambs go on feed with little or no digestive disorders and consequently with lower death loss than in the case of full grain feeding. This method of feeding has already been adopted by many feeders and followed with entire satisfaction. It is recommended to Kansas feeders generally, especially those living in sections where the supply of roughage normally is large compared with the supply of grain.

With forage sorghums and the taller growing grain types, it is usually necessary to add extra grain to the ration to finish lambs. Any of the common types of feed grain are satisfactory for this use. In the dwarf types of sorghums the grain content of the fodder may run as high as 70 percent or 80 percent, in which case it is too con-



centrated to feed with safety. This fodder may be augmented with extra roughage of any kind suitable for lambs, or it may have some of the grain removed. In addition to the method mentioned above for removing a portion of the grain, some mills and grinders are now available which will thresh and remove a portion of the grain, grinding and mixing the rest with the roughage.

While it has been demonstrated that alfalfa is not absolutely necessary in the lamb-fattening ration, there is no question but that its use, even to a limited extent along with ground fodder, will increase the efficiency of the ration, provided it is not unreasonably high in price compared to other roughages. A roughage ration of one-half ground grain sorghum fodder and one-half alfalfa has proved equal to alfalfa for fattening lambs in tests conducted at this station. Thus the prices of these two types of roughage should determine which should be fed or whether a combination of the two would be more economical.

**Prairie Hay.**—Good quality prairie hay can be used as roughage for fattening lambs with moderately good results. Limited experimental results, together with observations of its use, indicate that it is worth approximately 60 percent to 70 percent as much as alfalfa for fattening lambs. Its value would vary, however, over a somewhat wider range than alfalfa because of the wide variation in its quality as affected by climatic conditions under which it was cured, kind of grass from which it was made, and the maturity of the grass when cut, as well as many other factors.

While prairie hay can be and often is fed successfully as the only roughage lambs receive throughout the entire fattening period, it is generally conceded that its greatest value is for use in getting lambs on feed immediately after arrival from the range. It is more like the dry, coarse range grasses that the lambs have been accustomed to eating. Feeders consider it less “washy” than alfalfa, especially when lambs are unaccustomed to eating large fills of hay. It is therefore safer to allow thin range lambs free access to prairie hay than to most other feeds. There is no question but that a small amount of ground limestone, together with adequate protein supplement fed with prairie hay would narrow the spread in value between it and alfalfa. There is sufficient information available to justify the recommendation that ground limestone be fed when prairie hay is used alone as roughage. When prairie hay and alfalfa are both available, but neither in sufficient quantity to use throughout the entire fattening period, the prairie hay may be used in the early part of the period and the alfalfa saved to feed as the lambs are finished for market. In many cases this practice will result in a saving on feed costs, whether or not it is necessary because of a limited supply of either feed.

**Silage.**—Many parts of Kansas are admirably suited to production of silage crops. Because of the saving of nutrients effected through curing the forage of corn and the grain sorghums or forage

sorghums as silage rather than dry curing them, silage is often the cheapest roughage available to many feeders in the state. Its use in lamb-fattening rations has been tested many times, and while it is generally not advisable to use it as the only roughage for lambs, it may be used to replace a portion of the dry roughage, especially alfalfa, with as good gains and at a saving of feed costs. Tests at this station indicate that silage can be successfully used to replace one-third to one-half of the alfalfa in the ration of fattening lambs. Where such replacement of dry roughage is made with silage, it should be done at the rate of three to four pounds of silage to one of dry roughage. The value of silage varies greatly with such factors as the kind of crop ensiled, its water content, the maturity and the amount of grain in the crop when it was put in the silo, and the individual process of curing it.



FIG. 32.—Sugar beet tops as they are commonly cured in the field, and grazed off by lambs before they are put in the feed lot.

Corn, grain sorghums and forage sorghums are the most common silage crops grown in Kansas. Silage made from corn and grain sorghums of equal maturity are considered equal in value for lamb feeding. Silage made from forage sorghums is considered somewhat less valuable because of the lower nutritive value of the grain it contains. When silage with good grain content is used extensively in lamb-fattening rations, the amount of grain in it should be determined and allowance made for it by reducing the grain feed. Occasional losses have been traced to heavy grain feeding caused by failure to take into account the grain supplied in roughages such as silage or fodder. Moldy, frozen, or otherwise spoiled silage should not be fed to lambs under any condition.

**Sugar Beet Tops.**—In harvesting sugar beets, the tops are cut off and left in small piles to cure in the field. Figure 32 shows beet tops as they are cured in the field. Lambs are often turned in to clean up the piles of tops and make several pounds of economical gains before being placed in the feed lot. Occasionally, these tops are fed as silage or hauled directly from the field and fed at the feed lot. Beet tops are ordinarily bought on the basis of the number of tons of beets produced per acre. The price varies with the price of

beets and of feeds. and opinions differ as to the actual feeding value of the tops.

The water content of the tops is unstable and variable with weather conditions. They may contain slightly more or considerably less moisture than average corn silage. They contain considerably more protein than the silage of corn or the sorghums and are therefore somewhat more growth-promoting. If lambs have access to all the tops they want in the field, no other protein supplement need be fed until they are put in the feed lot. If any appreciable quantity of beet tops is fed as a part of the feed-lot ration, the amount of protein supplement needed will be reduced.

When beet tops are hauled to the feed lot, perhaps the best method of handling them is to feed them through hay panels, on the ground.



FIG. 33.—Grinding beet tops and Russian thistles together with a hammer mill, to provide an emergency roughage for lambs.

Some feeders make silage of them, however. Owing to the fact that beet tops tend to put growth on lambs and not fatten them readily, and further because beet tops are difficult to handle and store, it would probably be best to utilize them for light or medium-weight lambs in the field before they are put in the feed lot for finishing. If this crop has to be hauled or handled much the cost involved is likely to exceed its value as a feed.

In any event, certain precautions are necessary in feeding beet tops to lambs. Like beet molasses, beet tops have a high alkali content. Therefore they are likely to cause severe scouring if the lambs are allowed large quantities before they become accustomed to this feed. Rather close supervision is required whether lambs are eating beet tops in the field or feed lot. The crowns on the beet tops become tough and woody when the tops begin to dry out. Lambs try to chew them and when they find they are unable to masticate them, attempt to swallow them whole and frequently choke as a result of the crown lodging in the throat. Such losses can be

prevented if the affected lamb is found before it is too late, by pushing the crown on down the lamb's throat with a short piece of rubber hose.

Some feeders make a practice of grinding or chopping beet tops in order to reduce the crowns. Figure 33 shows beet tops and Russian thistles being ground for lambs. This must be regarded as an emergency roughage, but the combination has given fair results in lamb fattening.

### PROTEIN SUPPLEMENTS

Few feeders question the value of using protein supplements in lamb-fattening rations, especially when no alfalfa or other leguminous roughage is fed. In actual practice, however, many do not use protein supplements even where the need is urgent, and especially is this true when the price of protein supplements is high. Many times the use of a small amount of supplement, even though it appears to be high priced compared with other feeds, will save large quantities of grain and roughage and actually cut the feeding cost. It is equally true that there are times when the use of protein supplements cannot be advised. Such a case is that in which the feeder can best use alfalfa hay as the only roughage and is so located that long hauls and transportation charges make the cost of protein concentrates excessively high. Under most Kansas conditions, with average feed prices prevailing, even if alfalfa is used as the only roughage, a small allowance of protein rich feeds will generally be of enough benefit to the growth and thrift of the lambs to more than repay its cost.

Cottonseed meal or cake and linseed meal or cake are the most commonly used protein supplements for lamb feeding in Kansas. A review of a large number of feeding experiments conducted at many experiment stations justifies only one conclusion regarding the relative feeding value of these two—that they are equal, pound for pound, as protein supplements for fattening lambs. Some feeders prefer cottonseed meal to the linseed meal, and some experiments show an advantage in favor of one, while other experiments show a correspondingly greater value for the other. Actually there is evidence to indicate that a mixture of equal parts of the two is superior to either one. In the light of the information we have at present, feeders are advised to buy the one which they can lay in at their feed lot at the lowest cost per ton.

From one-seventh to one-fourth pound of either of these supplements per lamb daily should be sufficient under most conditions for purely protein supplemental purposes. However, much more than this amount can be fed and no ill effects will be produced, nor will the feed be wasted when the supplement and the grain used are near the same price level per pound. The amount of cottonseed meal or linseed meal fed should be governed by the kind of roughage fed and the relative price of these feeds compared with the grain fed.

Corn gluten meal, peanut meal, and soybean meal are all protein supplements which are continually being used more in lamb feed

lots in Kansas. Limited experimental work with them, places their feeding value at nearly the same level as that of cottonseed meal and linseed meal.

The best form in which to feed these plant protein supplements depends on the location and feeding plan. The meal form is perhaps best in ground self-fed mixtures. The "screenings," pebble size or pea-size forms, are preferable to mix with whole grain or where the wind blows the meal out of the feeders.

Tankage and meat meal have also been rather widely used in lamb-fattening rations, when the price of these packing house by-products has compared favorably with that of the protein supplements of plant origin. Contrary to popular opinion, lambs eat these feeds readily, when they are fed only in amounts needed to furnish the necessary protein. Because of their higher protein content, probably smaller amounts of these supplements are needed than is the case with the plant proteins discussed previously. The Kansas Agricultural Experiment Station has recently conducted a lamb-feeding experiment in which cottonseed meal, linseed meal, peanut meal, dry-rendered and steam-rendered tankage were compared as protein supplements. The difference in value was not wide, but the results placed the supplements in the following order: steam-rendered tankage, dry-rendered tankage, peanut meal, cottonseed meal and linseed meal.

#### MINERALS

**Salt.**—Salt should be provided at all times for lambs on feed, regardless of what feeds are used. However, there is great danger of losses if lambs are shipped in from the range and allowed free access to salt soon after arrival. In most cases they have not had all the salt they needed on the range and this, together with the increased appetite for salt created by a change of feed and an improved state of nutrition, is very likely to cause them to eat enough salt to kill them. They must therefore become accustomed to salt gradually. This can be done by feeding a small amount of loose salt well scattered in the troughs, gradually increasing the amount until the lambs have overcome their accumulated salt deficiency and have lost their abnormal appetite for salt. Block salt is useful also for this purpose, as it is difficult for lambs to get enough of this form to injure them. After they have become accustomed to salt in a week or ten days, lambs may be safely allowed free access to it. Thereafter the loose form is more satisfactory than block salt as they grind their teeth badly on block salt in an effort to satisfy their needs. Lambs will eat from two to three pounds of loose salt per 100 head daily, if allowed free access to it, although the amount consumed may vary over a wide range, depending upon the kind of feed received.

**Ground Limestone (Calcium Carbonate).**—Recognizing the fact that the roughage portion of the sorghums as well as corn fodder, prairie hay and other nonleguminous forages are deficient in calcium

or lime as well as protein, the Kansas Agricultural Experiment Station has conducted numerous feeding tests with these feeds in an effort to find a satisfactory substitute for alfalfa. It has been definitely established that where one of the above roughages is fed and no alfalfa or other leguminous roughage is included in the ration, ground limestone has a decidedly beneficial effect by increasing the gains made by the lambs receiving it, compared to others receiving the same kind and amount of feeds but getting no ground limestone. This practice results in a great saving on feed costs and is to be strongly recommended where such roughages are fed exclusively.

Apparently one-fourth ounce of ground limestone per lamb daily is sufficient. This equals approximately one and one-half pounds per 100 head daily. It can be mixed and fed with the grain and protein supplement or with ground roughages. Some feeders make a practice of mixing ground limestone and salt, equal parts, and giving lambs free access to it. This is apparently a satisfactory practice.

#### HAND-FEEDING AND SELF-FEEDING

Because of the fact that considerable interest is shown in self-feeding and hand-feeding as methods of feeding lambs, a brief discussion of the relative merits of the two systems is included. Neither method is best under all sets of conditions.

The saving of labor is the chief advantage claimed for self-feeding. It is true that this advantage exists, and under some conditions the saving is considerable. It is also true that less disturbance to lambs in the feed lot results where self-feeding is followed, and that somewhat faster gains usually follow. Hand-feeding must be recognized as a safer practice, however, particularly for beginners or where the feeding is entrusted to those who may become careless at times. While gains are ordinarily slower than is the case with self-feeding, usually gains are produced more economically by hand-feeding. Experiments and observations have also shown that, death losses are usually somewhat lower where lambs are hand-fed. This is not always true, however, especially when self-feeding is carefully and skillfully followed.

It has been pointed out previously that a balanced consumption of concentrates and roughage is necessary in lamb feeding. This is not a hard matter to control, but is important regardless of the method of feeding followed. In hand-feeding a balanced consumption can be obtained by supplying the proper amount of feeder space, placing feeders so they are readily accessible to all the lambs, then distributing the proper allowance of grain. Roughage is usually full-fed in such a system.

Where self-feeding is followed, it is necessary to grind and mix the concentrates and roughage thoroughly, otherwise the proportion of grain consumed in the diet is sure to be too large. Several factors should govern just what this proportion should be and these are discussed under the subject "Getting Lambs on Feed," page 62.

It should be remembered that self-feeding lends itself more readily to use in sections where the climate is moderately dry throughout the feeding period or where the feeders are housed. It is important that molds and spoilage be prevented in the feeds offered to lambs.

In considering the facts regarding the two feeding systems discussed above, it becomes apparent that local conditions, or specific farm conditions for the most part determine which is the better practice. Often both practices are used by feeders in the same community, and this may be justified. Attention is directed to the fact that in spite of the drawbacks which might accompany either of these feeding methods, local situations may sometimes justify both. It might be, for example, that the labor saving would more than offset additional feed costs or a slightly larger death loss. It is for each feeder to weigh the relative merits of these two systems after considering the facts regarding them, and decide for himself which will best fit his conditions.



FIG. 34.—When lambs are used to harvest rank-growing corn, such as this, they will learn to eat grain much earlier if parts of a few rows are dragged down for them at first.

#### LAMBING DOWN CORN AND GRAIN SORGHUMS

The practice of harvesting corn or grain sorghum crops with lambs is one that has received increasing attention by Kansas feeders. The greatest advantage and perhaps the only one, of this method of feeding lies in the fact that the labor of harvesting and feeding the crop is saved. Feeders should not fail to figure in the cost of the necessary fencing or of hiring herders if this practice is to be followed. At best it is a somewhat wasteful method of feeding and generally can be recommended only for crops of poor yields or of low quality, where the advisability of harvesting is questionable.



Crops of high grain yields can be more profitably utilized if harvested and fed in the feed lot. (See figures 34 and 36.)

There is always a danger of unbalanced grain and roughage consumption connected with the practice of lambing down grain crops. Generally lambs directly from the range, when turned into corn or sorghum fields will eat only weeds and the leaves and the finer stalk material within their reach before starting on the grain. This is especially true of the taller growing crops. As a result there will soon be nothing but grain left for them to eat, and a sudden change to an exclusive grain ration likely will cause sudden and extensive death losses. It is therefore necessary to take steps to insure a reasonable roughage consumption along with the grain eaten. There are several methods by which this may be done. In many instances some palatable roughage such as alfalfa is kept in feeders in the field



FIG. 35.—Lambs cleaning up both grain and roughage as they go, in short-growing corn in northwestern Kansas. There were 640 acres in this field and over 6,000 lambs grazing in it. Note the inexpensive but adequate temporary fence in the foreground.

near the gate where the lambs are turned in. The lambs will thus eat a considerable amount of hay, which with the roughage they glean in the field will probably be sufficient to keep down digestive disorders of a serious nature. Because of the fact that it is generally necessary to put lambs in a corral at night for protection from predatory animals, roughage can be fed there and usually lambs will take on a good fill in the morning before they go to the field, especially if they are held in until they are hungry.

Protein supplement is as important for lambs in the field as for those in feed lots. The same is true of ground limestone if no alfalfa is being fed. Both may be fed in troughs in the field or in the lot. It is better to feed protein supplement only in the morning before the lambs go to the field.

It may be advisable to hold lambs that are intended for the field in the feed lot for several days and get them accustomed to the grain which they are to receive before they are turned out. This always has some tendency to encourage a more uniform grain and roughage consumption from the start. Sometimes this same end is accom-

plished by dragging down a row or two of corn or sorghums at first so that the grain is readily accessible and lambs learn to eat it while there is still roughage available in the field. Where corn grows as



FIG. 36.—Wheatland milo grown under irrigation in the Arkansas River valley in Finney county, Kansas. Occasionally such crops are lambed down; however, this is an expensive and wasteful method, where grain yields are high. This is a combine type of grain sorghum and the grain can be harvested and fed in the feed lot more economically. (Photo courtesy Earl Richardson, Garden City, Kansas.)



FIG. 37.—A common sight each morning at the bed grounds if a balanced grain and roughage consumption is not assured. These lambs were held too long in one area, such as that shown, where the grain had all been consumed, and when moved to a fresh area, gorged themselves with grain. Note the temporary, easily movable fence.

rank as that shown in figure 34, lambs are slow to find the grain unless some of it is dragged down for them at first. In short-growing corn, such as that in figure 35, they are more likely to consume both grain and roughage as they go. It is always advisable, either by use of temporary fences or herders, to hold lambs on a certain portion of the field until they have cleaned up both the grain and

the best of the forage material before they are allowed to go to an ungrazed section. Holding lambs too long on one area may result disastrously as will be noted in figure 37. Ordinarily it is better to



FIG. 38.—Uniformly grazed field of dwarf yellow milo. Grain and roughage are both still available in the field, insuring a balanced consumption of each.

allot them an area sufficient to last them a week or ten days. Holding lambs on a larger area longer than ten days causes the refusal of too much feed due to their trampling and bedding down on it. Figure 38 shows lambs grazing down dwarf yellow milo uniformly



FIG. 39.—A well-cleaned-up field of milo. These lambs are being moved to a fresh feed supply in another section of the field.

with a minimum waste of grain or roughage from trampling. Figure 39 illustrates how lambs can and will clean a field, if properly handled. Under no condition is a feeder justified in allowing lambs to run at will over a large grain field with sufficient feed to last them for many weeks or perhaps months.

If fences are used in the field, a light grade of 30-inch woven wire of coarse mesh, supported by steel posts at rather long intervals will serve the purpose. (See fig. 35.) If lambs are herded, one man can handle as many as 3,000 satisfactorily. Less waste in trampling results, however, if they are grazed more openly in somewhat smaller units. For lambing down fields, lambs weighing at least 60 pounds are more desirable. Smaller lambs usually lack the necessary aggressiveness. Open-faced lambs are also more satisfactory. Woolly-faced lambs should have the wool shorn from around their eyes. A few sheep bells used in large bands will prevent lambs becoming separated and lost from the main band.

If possible, arrangements should be made to water lambs in the field at mid-day or more often.



FIG. 40.—Lambs on good wheat pasture, almost ready for market. Note the field of milo in the background, which can be used when the wheat pasture is covered with snow. This is an excellent precaution to take when lambs are fattened on wheat pasture.

#### FATTENING LAMBS ON WHEAT PASTURE

During the past three or four years many thousands of lambs have been fattened entirely on wheat pasture in Kansas. In some instances packers have complained of the lack of a firm finish when the carcasses of wheat-pasture lambs were hung in the coolers. In almost, all such cases, however, the cause has been traced to the practice of sending lambs to market before they had attained a satisfactory finish. This has been due both to a lack of knowledge of how to sort fat lambs because of insufficient experience, and to running out of pasture and having no other feed available. If lambs are left on good wheat pasture long enough, a desirable market finish and good carcasses are produced without other feeds. Figure 40 shows lambs practically ready for market on wheat pasture.

A light feed of dry roughage helps to satisfy the appetite and is beneficial from the standpoint of producing gains on lambs on wheat pasture. This is especially to be recommended when lambs show signs of digestive disorders or stiffness and rheumatism due to over-consumption of feed. Otherwise unless some such trouble develops, it is doubtful if the feeding of roughage, grain, protein supplement, or mineral is economical as long as the pasture is good and lambs are able to satisfy their appetites without an excessive amount of exercise. In other words, the feed supply should be sufficient to allow the lambs to bed down 2 to 3 hours during the day.

Wheat pasture is nutritious and lambs should not be turned suddenly onto rank growing wheat for the entire day when they are unaccustomed to it. They should become accustomed to it gradually by grazing for short intervals at first, or by feeding them roughage in the lot each morning before they are turned out. If the lambs refuse the roughage they should be held in until they are hungry enough to take on a partial fill. Wheat-pasture fattening of lambs should not generally be attempted unless a reserve supply of rough feed is available to carry them over wet or stormy periods when the pasture is covered with snow. (See figure 40.) To do otherwise is to risk a tremendous loss.

Gains of five to fifteen pounds per month have been reported for lambs on wheat pasture. Perhaps seven to eight pounds per month is a good average, where shrinkage is taken into account. A section (640 acres) of good wheat pasture should accommodate from 1,000 to 4,000 lambs. The carrying capacity varies widely with the seasons, section of the state, climatic conditions, and other factors. The carrying capacity can be appreciably increased if the field is temporarily divided or if two fields are available, making it possible to rotate the lambs and allow the pasture a short recuperative period. Lambs graze more closely than other animals.

Charges for pasture for lambs have ranged from 8 cents to 20 cents per head per month for the past three or four years. This charge, too, is variable and would depend somewhat on the price of lambs and other feeds, whether water, reserve feed, salt and even the labor of looking after the lambs is furnished, as it sometimes is.

Most of the statements made regarding the high nutritive value of wheat pasture apply somewhat more to Central and Western Kansas and similar sections. Many Eastern Kansas farmers and feeders have put lambs on rank wheat pasture, expecting as good or better results than are obtained with short wheat pasture in Western Kansas. Usually they have been disappointed and quite often such a venture turns out badly. Apparently green wheat grown in drier sections has more nutritive value than rank growing wheat produced where there is more rainfall. It is not known whether the difference is due to mineral, protein or to moisture content, but it may be influenced by all of these factors. Wheat grown in the drier areas contains more protein and mineral and less moisture than that grown where rainfall is heavier. Probably the chief reason for

its higher nutritive value is its higher dry matter content, most of which is digestible. Regardless of the cause of the difference in results obtained, it is obviously true that wheat pasture grown in Western Kansas produces better gains on livestock than rank growing wheat in Eastern Kansas.



FIG. 41.—Lambs fattening on alfalfa pasture in November. Ordinarily this should not be practiced in Kansas until most of the top growth has been killed by freezing.

Alfalfa pasture is sometimes used partially to fatten lambs. Those shown in figure 41 are grazing alfalfa which was still green in November. It is ordinarily not safe to graze lambs on alfalfa in Kansas unless most of the top growth has been killed by a frost or freeze. If there is much green alfalfa available, lambs must not be exercised much, especially in the warm part of the day, as bloating and death losses are likely to follow.



## PART VI

### Lamb Feed-lot Management

#### GETTING LAMBS ON FEED

The period during which lambs are going on a full feed of grain is in some respects the most critical part of the feeding operation. In most cases the lambs have just recently been shipped from the range, and have never eaten grain. They usually arrive in a more or less emaciated condition, since the nervousness incident to shipment causes them to refuse feeds that are new to them and which are offered to them en route. They have been accustomed to filling up on coarse range grasses and weeds and their first incentive is to fill up on whatever feed is offered them. A heavy grain feed or other concentrates at this time, sufficient to allow some of the lambs to gorge themselves, is disastrous. In numerous instances where death losses occur later in the fattening period, they can be traced to the lambs eating too much grain when they are starting on feed. To avoid gorging, lambs should always be given a good fill of hay, stover or other roughage before they are allowed access to grain. When grain feeding is started it should be in limited quantities, increased gradually, and a full feed of roughage fed at all times.

The rations in Table I are suggested only as an aid in getting lambs safely on full feed. They are meant to conform approximately to their needs, and not to represent ideal conditions.

The ration listed in Table I, consisting of corn, alfalfa hay, and protein supplement, is considered somewhat of a standard ration for fattening lambs. Most farm grains may be substituted for corn, and other protein supplements for cottonseed meal, in similar amounts. If prairie hay or other nonlegume roughage is fed instead of alfalfa, the protein supplement allowance should be increased to 20 or 25 pounds per 100 lambs. Many successful feeders stop increasing the feeds when amounts corresponding to those listed for the fifteenth day are reached, and consider that a full grain feed has been reached, especially for light and medium-weight lambs. This is an altogether satisfactory fattening ration and will produce as well-finished lambs as heavier grain feeding, but requires a little more time. Other feeders frequently exceed by far the quantity of grain shown in the table, with good results, providing the heavy grain feed does not run over too long a period of time. The relative price of grain and roughage, the average size and condition of the lambs, and the time element should largely determine which practice is used.

In Table II is included a ration recommended for grain sorghum growing regions. As stated in the footnote, the ground fodder may be used for the initial fill providing the grain in it does not represent more than 15 percent to 20 percent of the total weight. It is there-



fore necessary that the feeder determine approximately the ratio of grain to roughage in the fodder before it is ground and adjust the ration accordingly.

TABLE I.—POUNDS OF FEED REQUIRED DAILY FOR 100 LAMBS.

DAYS ON FEED.	Corn.	Cotton-seed meal.	Alfalfa hay.
1.....			Full feed
3.....	10	5	Full feed
4.....	20	10	Full feed
5.....	30	15	Full feed
7.....	50	15	Full feed
10.....	75	15	Full feed
12.....	90	15	Full feed
15.....	100	15	Full feed

TABLE II.—POUNDS OF FEED REQUIRED DAILY FOR 100 LAMBS.

DAYS ON FEED.	Grain.	Protein supplement.	Ground grain sorghum fodder.	Ground limestone.
1.....		10	*Full feed.....	1.5
3.....		15	ditto.....	1.5
5.....	20	20	ditto.....	1.5
7.....	40	25	ditto.....	1.5
10.....	60	25	ditto.....	1.5
15.....	80	25	ditto.....	1.5
30.....	100	25	ditto.....	1.5

\* Ground grain sorghum fodder may be full-fed from the beginning of the feeding period providing it does not contain more than 15 percent to 20 percent grain by weight. Otherwise it should have hay, stover, or some other roughage fed with it at first. If it contains as much as 50 percent grain, as some varieties often do, no grain need be added throughout the feeding period.

The amount of grain to be added to the ration later should be governed by the amount contained in the fodder. If the fodder contains a larger amount of grain, it is suggested that a certain proportion of the bundles, from one-fourth to three-fourths, depending on the grain content, be headed before grinding. The headed bundles can then be ground with other whole bundles to start the lambs. Later when the lambs are on full grain feed the extra heads thus obtained can be ground and fed with the fodder. In Table II the extra grain is adjusted for fodder containing about 20 percent grain. If there is more than 20 percent grain in the ground fodder, the other grain should be reduced correspondingly, and in case of some of the

very dwarf sorghums with a heavy grain yield, no extra grain at all may need be fed with it, and in many cases roughage should be added.

The ration as listed after thirty days of feeding may well be considered a full feed. These amounts of grain, protein supplement and ground fodder have produced prime fat lambs in from 75 to 110 days at the Kansas Agricultural Experiment Station. If the feeder has relatively more fodder than grain to dispose of, he will find this a more economical ration than one containing more grain, or better still, he should follow the deferred grain feeding plan previously discussed. In this case the same feeding schedule listed could be followed except that no grain would be added for approximately thirty days. Thereafter grain could be added according to this schedule or somewhat faster. The ground limestone is included in this ration because tests at this station and others have shown that one-fourth ounce per lamb daily, or approximately one and one-half pounds per 100 lambs, increases the gains and lowers the feed cost in rations containing only nonleguminous or low calcium roughages.

Where lambs are fed with self-feeders the percentages of concentrates and roughage consumed must be controlled by moderately fine grinding and thorough mixing of the grain and roughage. Otherwise the lambs will soon learn to pick out the particles of grain and eat very little roughage. This is usually expensive, and may result in death losses.

Table III contains suggested percentages of the different feeds to use in a ground mixture for getting lambs started safely on the self-feeder.

TABLE III.—PERCENTAGES OF FEEDS IN A SELF-FED GROUND MIXTURE.  
 (BY WEIGHT)

DAYS ON FEED.	Grain, percent.	Cottonseed meal, percent.	Alfalfa percent.
1.....		2	98
5.....	5	3	92
10.....	15	5	80
15.....	30	7	63
20.....	40	7	53
30 and thereafter.....	50	7	43

The ground ration of grain, cottonseed meal and alfalfa hay listed in Table III is one which is commonly fed in self-feeders to fattening lambs. The amounts suggested are based on the assumption that no other feeds are fed, other than those fed in the self-feeder. Frequently some other palatable bulky feed such as beet tops, hay,

wet beet pulp, or silage is fed in addition to the self-fed mixture. Where this is the case, the percent of grain in the self-fed mixture may be correspondingly increased. It should be remembered that self-feeding must be practiced with caution, and that the ratio of concentrates to roughage be carefully and uniformly controlled. With self-feeding, as with hand-feeding, some feeders prefer to feed a more liberal grain allowance than that suggested in Table III after 30 days' feeding. It is doubtful whether it is advisable ever to feed much more than 50 percent concentrates in the ration unless it be for a very short period of time just previous to marketing, when much richer feed can be fed if proper precautions are taken. On the other hand, a properly compounded self-fed mixture containing no more than 35 percent to 40 percent concentrates will fatten lambs satisfactorily, if fed for a longer period.

In the foregoing discussions relative to getting lambs on feed, it is not meant to convey the impression that the schedule of feeding listed in each of the various tables is the only schedule, or the best one that can be followed. It is merely suggested as an approximate guide and one which is known to be a safe and practical method of bringing lambs up to a full feed.

The feeder is reminded that constant vigilance is necessary at this stage of the feeding period and that no guide or form should be followed blindly. If lambs begin to scour, throw up grain or show other signs of going on feed too rapidly, the grain allowance probably should be held constant or reduced for a day or two, and then increased gradually as before.

Following is a series of suggested sample rations which have given good results in fattening lambs. Feeders may find that the feeds in some of these rations correspond in kind and proportion to those which they themselves have, and may wish to use some of the rations suggested. It should be remembered that these are only approximate guides and that substitutions can be made when it seems advisable, for any feed listed, with as good results and often with a reduction in feed cost.

It is further pointed out that the results obtained from feeding these various rations are not necessarily the same. However, it has been shown on numerous occasions that all of these produce satisfactory gains and finish. The amounts listed are pounds of feed for 100 lambs for one day's feeding. The relative prices of the different classes of feeds, and the size and degree of finish of the lambs are factors which would justify increasing or decreasing the amounts of feeds or the concentration of the rations.

TABLE IV.—POUNDS OF FEED REQUIRED PER 100 LAMBS DAILY.

	Ration 1.	Ration 2.	Ration 3.	Ration 4.	Ration 5.
Corn <sup>1</sup> .....	100	150	125	100	75
Cottonseed meal <sup>2</sup> .....	15	.....	.....	.....	.....
Alfalfa <sup>3</sup> .....	225	175	200	250	350

1. Grain sorghums or wheat may be substituted in equal weights for corn. Sorghums may be used to replace entirely the corn while the wheat should not constitute more than 50 percent to 75 percent of the grain ration. Barley or oats may be fed instead of corn at the rate of 1½ pounds barley or 1½ to 1¾ pounds oats for every pound of corn replaced.

2. Linseed meal, soybean oil meal, peanut meal, corn gluten meal or tankage may be substituted for cottonseed meal if cheaper.

3. Well cured clover hay, soybean hay or other good legume hay may be used instead of alfalfa. Nonleguminous roughages may be fed successfully instead of alfalfa, providing the protein supplement allowance is increased from 15 to 20 or 25 pounds, and providing 1½ pounds of ground limestone or some other good source of calcium carbonate is fed per 100 lambs daily.

TABLE V.—POUNDS OF FEED PER 100 LAMBS DAILY.

	Ration 6.	Ration 7.	Ration 8.	Ration 9.	Ration 10.	Ration 11.	Ration 12.
Corn <sup>1</sup> .....	60	60	100	60	75	125	100
Dried beet pulp.....	60	60	.....	.....	.....	.....	.....
Molasses.....	.....	.....	.....	60	40	.....	.....
Wet beet pulp.....	.....	.....	300	.....	.....	.....	.....
Beet tops.....	.....	.....	.....	.....	.....	250-300 feedlot or pastured	300-400 feedlot or pastured
Cottonseed meal <sup>2</sup> .....	.....	15	.....	15	15	.....	.....
Alfalfa <sup>3</sup> .....	225-250	200	175	200	200	150	.....

1, 2, 3. See footnotes for Table IV.

TABLE VI.—POUNDS OF FEED REQUIRED PER 100 LAMBS DAILY.

	Ration 1.	Ration 2.	Ration 3.	Ration 4.	Ration 5.
Milo grain <sup>1</sup> .....	100	125	125	125	150
or Ground milo heads.....	or 175	or 175	.....	or 175	or 200
Cottonseed meal.....	25	25	20	25	25
Sorghum fodder or stover <sup>2</sup> .....	200-300 (full fed)	150	125	150	200
Sorghum silage.....	.....	.....	.....	300	.....
Alfalfa.....	.....	50	125	.....	.....
Ground limestone.....	1.5	.....	.....	1.5	1.5

1. The grain or heads of any of the better grain types of sorghums can be used instead of milo, with good results. Sweet sorghum grain has not proved equal to that of grain types.

2. The fodder and stover of many different varieties of grain and forage sorghums have been used as roughage for fattening lambs with almost equal results. If fodder is fed, its grain percentage should be determined and a reduction made in the grain ration fed, corresponding in amount to that fed in the fodder. (See discussion of this subject in section on feeds for fattening lambs).

### Length of the Feeding Period

Many new or prospective lamb feeders inquire as to the length of time required to fatten range lambs, the rate of gain to expect, and consequently the best time to start lambs on feed in order to have them reach the market at the season of the year when it usually is highest.

An average of one-fourth to one-third of a pound gain per head daily over the whole feeding period is considered a good gain on medium and light feeder lambs. Much heavier gains are frequently reported, and are possible especially with heavy feeder lambs and for short feeding periods. One-fifth of a pound daily gain net (shrinkage to market deducted) may be a good gain for light lambs, especially where they are pastured in stalk fields before going into the feed lot, or where an extended period of deferred grain feeding precedes full-feeding. The feeding period then will vary in length, depending on the weight of the lambs when they come in, and the method of feeding which is followed. Average sixty-pound range feeder lambs may be expected to be ready for market after 90 to 120 days of full-feeding.

The market for feeding lambs is usually lowest in late September, October, and early November, which is a period of heavy range sheep marketing. The lightest receipts of fat lambs usually come in March, April and early May, and fat lamb prices are usually strongest at this time. Consequently, it may not always be most profitable to buy feeders at the lowest point in the early fall months nor to sell fat lambs at the peak price period. Fat lambs that are ready for market cannot profitably be held over long to wait for higher prices. No class of livestock is penalized more on the market for being too heavy than are fat lambs.

Feeders must realize that it is impossible for them to predict the market course accurately. Therefore, they will be more successful in the long run if they buy their lambs advantageously when their feeds are ready, follow approved feeding practices, and market the lambs when they are ready without trying to out-guess the market.

### SHEARING FEEDER LAMBS

There is often considerable speculation on the part of lamb feeders regarding whether it pays to shear lambs while they are on feed. The inquiries received indicate that the most interest is evidenced in this matter when wool prices are rising, or are high. This is naturally to be expected. However, feeders apparently get the mistaken idea at times that if lambs are shorn previous to marketing, they are ahead just the value of the wool. This of course is not the case. Shorn lambs always sell lower than woolled lambs, although the spread may be sufficient to make shearing profitable at times. The cost of shearing, wool prices, and relative prices of shorn and woolled lambs will enable the feeder to determine whether it would be profitable to shear.

Another consideration, perhaps more important, is that of weather conditions. If it becomes apparent that lambs will not be ready for market until after several weeks of warm weather in the spring, it frequently will pay to shear, regardless of wool and market prices. Woolled lambs do not stand heat well when they are in relatively high condition. Their gains may be severely checked, and it may be difficult to keep them on feed. If shorn at such a time, they almost invariably respond by a rapid increase in gains and more efficient use of feeds.

Shearing too early should be avoided. If there is danger of severe cold spells, shearing may be the cause of a loss of weight or perhaps of pneumonia, followed by considerable death loss.

#### AVOIDING WEIGHT LOSSES AND DEATH LOSSES

The extent of the feeder's responsibility and limitations in controlling death losses is often not fully realized by lamb feeders. Consequently insufficient effort is put forth in advance to minimize death and weight losses and they may be allowed to start, and perhaps to get out of control before anything is done.

Certainly the matter of death loss and weight loss or failure to gain are among the major factors affecting the financial outcome of lamb feeding operations. Furthermore, they are among the things which are largely within the control of the feeder in the majority of cases. Some death loss usually occurs and may be considered normal, however, every effort must be made to keep it in check if a profit is to be made. A heavy death loss may turn an otherwise good and profitable job of feeding lambs into a losing enterprise. Just what percent of death loss is considered normal is a matter of opinion, and is governed very largely by the kind of lambs fed, the type of feed used, and the method of feeding and handling lambs. Most feeders agree that a loss of approximately two percent is normal, and the average death loss among lambs fed by experienced feeders over a period of several years is probably not far from this figure. Some few feeders consistently operate with a loss of one percent or less while others are unable to feed lambs without the losses running regularly above normal. Sometimes certain feeds or combinations of feeds are used, with which it is impossible to have an extremely low death loss, but, which for several reasons can be more profitably used than some other feeds. In rare cases rapid gains may be important. Rapid gains are nearly always accompanied by a heavier death loss than slower gains. In cases like the above it may be that a feeder would be justified in accepting a death loss one or more percent higher than otherwise necessary in order to use feeds or methods which for various reasons appear to be best for his situation. In most instances, however, the feeder can afford to sacrifice a great deal on time required for fattening to keep his death loss within normal range.

The various things which cause death losses among lambs in the feed lot are diseases of the infectious or noninfectious type, predatory animals, and parasites. Loss of weight, or failure to gain in weight may be caused by minor disorders brought about by allowing lambs to overeat or by other mistakes in management or feeding.

Only those losses which have their cause, and, for the most part, their correction in management methods and proper feeding, will be discussed. When any disorder occurs which will not respond readily to readjustment in management or feeding, feeders are advised to consult a graduate veterinarian.

### INDIGESTION AND RELATED DISORDERS

Often lambs are bothered somewhat with indigestion when they reach the feed lot, incident to the fright and nervousness of shipping and the change of feed. Generally they have been taken from the ewes on the range and loaded on the cars for shipment almost immediately. Indigestion may also occur at any time during the feeding period. The causes of indigestion in its various forms may be many. One of the common causes is overeating of grain, and this must be guarded against constantly. No matter how little feed is offered in getting lambs on feed, there are always a few which will eat but little while others will get more than their share.

Again indigestion in one of its worst forms may result from the failure of the feeder to adjust properly the proportion of concentrates and roughages consumed by the lambs. Lambs must eat a certain amount of roughage or bulky feeds in order that the digestive system function properly. Too heavy a roughage ration never causes digestive trouble unless it is composed of fine, highly nutritious roughage such as fine quality alfalfa hay, but too little roughage and too much concentrates fed in an attempt to speed up the fattening process often causes lambs to go off feed and may cause impaction and finally death.

A sudden or complete change of feed often will cause indigestion or throw lambs off feed. Allowing them to eat moldy feed or feed spoiled in any manner also will cause lambs to go off feed. Another cause of lambs going off feed, and of indigestion, is an abrupt change in the weather. If the weather has been cold, and suddenly warms up, lambs often lose their appetite to a marked degree, and especially when the warmer weather is accompanied by rain or melting snow. If they continue to eat the usual amount of feed, indigestion will often result.

It is not difficult to determine when a lamb is off feed, or when they have digestive trouble, although it affects lambs in different ways, and the symptoms are not always the same. A lamb off feed usually hangs back and does not come up to the feeder when the feed is first put in as the other lambs do, although he may eat a little later. They appear drowsy and lifeless at times, and fail to show the alertness they should. When lambs are bothered with indigestion they may scour or bloat, but many times do neither.



When too much grain is being eaten lambs will often be seen to throw up a mouthful of grain, and there may be small piles of grain which has been thrown up by the lambs at the bed ground. This is not necessarily a symptom of present trouble, but is a sort of safety system for the lamb and a warning that future trouble is near. Usually this is an indication that all of the lambs are being fed too much grain, rather than that a few greedy ones are getting more than their share, and hence should be regarded by the feeder as a timely warning to decrease the grain and concentrated feeds, and to induce the lambs to eat a little more roughage. Often overeating apparently will affect the brain of lambs, and they may be observed to throw the head back in a characteristic position with the nostrils raised on a level with the eyes. Often they may shake the head slightly while it is in this position. This particular ailment is sometimes known as "apoplexy" and is known by many different names in various localities. It is definitely known to affect the brain, and to be the result of overeating. Stiffness or rheumatism sometimes occurring among lambs on good wheat pasture or on a highly nutritious ration probably has its origin in digestive disturbances.

#### TREATMENT

The causes of most of the digestive troubles suggest the treatment which should be followed. Prevention, of course, is the best measure, and a feeder, by close attention to feeding and by including plenty of bulky or rough feeds in the ration, can minimize the trouble from these sources. At best, however, there will always be some difficulty from lambs going off feed and from digestive troubles.

In the first place, every feeding plant should have its hospital pen. When a few lambs scour, bloat or show other symptoms of digestive disorders already established, they should be removed to the hospital pen, and put on an exclusive hay feed with no grain, or with the grain feed greatly reduced, until they recover. In some cases a physic will help, but usually the cure lies in adjustment of the ration. When lambs go off feed, or merely throw up grain, ordinarily no treatment is necessary, other than to adjust the ration. This is best done by reducing the grain fed, or where self-feeding is practiced, changing the ration to include a smaller proportion of concentrates and a larger proportion of bulk or roughage. Feeds must be constantly observed to avoid feeding badly molded or spoiled feeds in large quantities, and this precaution becomes even more necessary in self-feeders where feed may spoil in the corners due to the collection of moisture. Generally lambs that have had indigestion in any of its more severe forms will never be able to take heavy grain feeds again, and in all cases where the feed has been reduced to effect recovery from these ailments, it should be very gradually increased back to full-feed again as was done in putting lambs on feed originally.

In the case of a rheumatic condition or stiffness often appearing among lambs on good wheat pasture, they should be forced to eat

some bulky dry feed. It should be remembered that while wheat pasture is classed as roughage, it is highly nutritious and produces results more like those produced by concentrates. As a rule it is necessary to confine the lambs to the lot at night and it is convenient and a good practice to feed prairie hay or similar feed before turning them out in the morning. Prairie hay is especially recommended for this purpose since it has a tendency to offset the laxative effect of the green wheat. Good, bright oat or wheat straw is also good for this use. Lambs usually refuse to eat much of such feeds at first, and in such cases they should be held in the lot until they are hungry enough to take a moderate fill of dry roughage. This practice need not be continued after the lambs are accustomed to the wheat and no further scouring or stiffness is evidenced. It is a good plan, however, to make dry roughage available to lambs all through their pasture period and they will eat considerable quantities of low grade feeds such as straw or stover. Dry buffalo grass pasture will accomplish the same purpose.

#### SORE MOUTH

Nearly all lamb feeders in Kansas or elsewhere, who have fed lambs for any considerable time, have encountered sore mouth among the lambs at some time. This is one of the commonest ailments of lambs when put in the feedlot. It usually occurs, if at all, soon after the lambs are put on feed, although it may be present when the lambs come in after shipment from the range, or it may appear after the lambs have been on feed for several weeks.

Sore mouth is not difficult to detect among lambs if a close watch is made from the time of the arrival of the lambs until they are on full feed. The likelihood of the appearance of the sores is so great during that time that particular attention should be given to the lips and nostrils. Usually the first appearance is in the form of small bumps or pimples on the lips, or scabby sores in the corner of the mouth. Often the case is rather far advanced before a lamb will refuse to eat. The small ulcerlike sores may be found both on the outside and the inside surfaces of the lips. The sores open and discharge and usually form a hard crust or scab. Usually the lips are swollen until they become thick and stiff.

Sore mouth is not a particularly serious disease in itself, and death losses, though occurring sometimes as a result of it, are few and of little economic importance. The greatest loss is the loss of weight or failure to gain on the part of the lambs suffering from it. After sores and scabs form on the lips and in the corners of the lamb's mouth, it is difficult for them to eat, and painful to eat hay or other roughages in particular. Figure 42 illustrates a lamb with an advanced case of sore mouth. Lambs thus affected eat but little or refuse to eat anything and usually lose weight rapidly and become weak and emaciated.

According to Doctors Boughton and Hardy who have made extensive investigation of this trouble at the Texas Agricultural Ex-

periment Station, sore mouth is infectious. They state that medical treatment of it is unsatisfactory and of no practical value in arresting the disease.

It has been observed that cases of sore mouth ordinarily run their course and heal of their own accord within two or three weeks' time. Perhaps the best course for feeders to follow is to isolate lambs affected with sore mouth and give special attention to the prepara-



FIG. 42.—Lamb with a severe case of sore mouth. When this disease progresses to as advanced a stage as this, lambs refuse to eat and lose weight rapidly and in some cases die.

tion of their feed. By grinding hay moderately fine and grinding the grain, lambs may be induced to eat enough to prevent severe weight loss. As stated previously, medical treatment is not advised. If feeders wish to try it, they should consult a veterinarian.

The authorities quoted above have produced a vaccine which appears to be effective in immunizing lambs against sore mouth infection. It may be that within a comparatively short time feeders will be justified in demanding that lambs coming from ranges where sore mouth infection is known to exist,

or that, lambs which are unloaded at a market point en route, be vaccinated against sore mouth. This condition should not be confused with the disease known as lip and leg ulceration.

#### URINARY CALCULI (WATER BELLY)

This disease of the urinary tract occasionally causes the loss of large numbers of lambs. It is a result of the formation of "gravel" or bladder stones in the bladder which partially or completely stop the urinary tract. The cause of the formation of these stones is not definitely known. It has been attributed to alkali water, the feeding of beet by-products, linseed meal, and various other feeds, but many cases occur for which none of the causes often listed is responsible. It affects only male lambs, and never ewe lambs. Some years it may be general over a large area where many different feeds and practices are used, while other years it may be rare. Apparently the formation of bladder stones has its origin in the early life of the lamb on the range. Many theories have been

advanced as to the origin of this trouble, and all have been dis-proved, or cases continue to arise for which adequate explanation is lacking.

Lambs developing bladder stones may show different symptoms. In practically all instances the wool on the abdomen around the sheath will be wet with urine. The blocking of the passage preventing or limiting the flow of urine distends the bladder and many times results in its rupture, allowing the urine to flow out into the abdominal cavity. The abdomen becomes very pendulous or floppy and full of fluid, hence the origin of the term "water belly" used by feeders. On the other hand, a lamb may become very shrunken and drawn in the abdomen and flanks, presenting the exact opposite in appearance from the "water belly" type of case. It will lie around the lot nearly all the time, or perhaps stand because of the pain caused by lying down, and they usually will refuse to eat. Frequently they stamp the hind feet when arising, and the head is held low. The animals often stand stretched, with the hind legs extended far back in an attempt to relieve the pain due to pressure. Lambs will be observed to urinate often and in very small amounts, or perhaps attempt it and be unable to, or the flow of urine will be reduced to a slow seepage.

Remedial measures for urinary calculi are usually unsuccessful. Occasionally when one or more of the stones lodge in the small curved end of the urethra (worm) this small end may be severed, allowing the stones to pass and the urine to drain out. In such cases recovery is rapid, even though temporary as a rule. Many times, more stones will move down and obstruct the passage again within a few days or a few weeks time. It is also possible at times to force stones from farther back in the pelvis with the finger and thumb, providing they are not lodged too high, although that is the most common place for them to lodge.

It has been observed that lambs will often recover from this trouble of their own accord. According to investigations made at the Indiana Agricultural Experiment Station, it was found that the first attack was likely to be followed by a second or third, and that if recovery was made from the first and second, in no instance did the animals survive the third attack.

A good veterinarian is able to operate and in many cases save animals which are suffering with bladder stones. Obviously this would not pay except in case of valuable breeding animals. Contrary to popular opinion, feeders may rest assured that no grain or roughage which they may be using is responsible for the formation of bladder stones. Therefore, changes in feeding practices cannot be recommended as an aid in overcoming the trouble.

At present about the best suggestion to those who encounter trouble with this disease among their lambs is to market the affected lambs as soon as possible, regardless of their lack of finish, and thereby avert a probable complete loss on them.

**PARASITES**

Occasionally parasites of either the external or internal type are responsible for slow or unsatisfactory gains by lambs. Of the external parasites, ticks cause more annoyance than any other. A little precaution on the part of feeders will save the loss of many pounds of weight and much feed on account of ticks. If heavy infestations of ticks are found, it is better to dip lambs at the market or some unloading point than to do so after they are brought to the farm. Usually the facilities for dipping are much better at terminal markets, and dipping there has the further advantage of helping to keep tick infestations off the farm. In any event dipping lambs after they are on full feed or during cold weather should be avoided. It is better not to dip at all than at such times, and if the infestation is not severe, perhaps it would be best to wait until spring and then shear lambs, providing they are not marketed before late spring. Ticks leave the sheep when they are shorn.

**STOMACH WORMS** Of the internal parasites affecting sheep, stomach worms are as a rule the chief cause of any appreciable loss of weight in feeder lambs, although tape worms are also troublesome at times. It is not often that range lambs carry heavy infestations of stomach worms, however, occasionally they do. In some range sections stomach worms are known to exist, and the range areas to which they have spread have increased somewhat in recent years. Furthermore, range feeder lambs frequently are grazed in farm areas for a time and pick up stomach worms there. In any event feeders should be sure that lambs are comparatively free from worms before they go on feed. Examination of a few lambs will usually reveal symptoms of stomach worms if they are numerous enough to cause much trouble. A wormy lamb usually shows a dull, brownish cast to the white of the eye. The skin around the eyes, lips, and on the body also appears anaemic and papery rather than showing the pink color of a healthy skin. Occasionally some coughing is noticed, and in severe cases some swelling of the throat, immediately back of the jaws, is found.

**METHODS OF CONTROL** It is not difficult or expensive to worm lambs if it is done correctly. Unless precautions are observed, however, they may be strangled and killed by drenching. If it becomes necessary to drench feeder lambs, perhaps as effective a vermifuge as can be used is a solution of one percent copper sulphate, mixed equal parts with a one percent solution of Black-leaf 40 (nicotine sulphate). This will control tape worms if any are present, as well as stomach worms. This solution can be made by pulverizing and dissolving blustone crystals (copper sulphate) in water at the rate of one ounce of the powder to 99 ounces (approximately 6 pints) of water, then making a similar solution of Black-leaf 40 and mixing the two as they are used. This solution should always be handled in glass, crockery or granite vessels, as it corrodes metal,

producing a poison. The dosage for an average feeder lamb weighing approximately 60 pounds would be from  $2\frac{1}{2}$  to 3 ounces. They should be drenched slowly and while they are standing. They should never be set up for drenching, nor should the head be held so that the nostrils are higher than the level of the eyes.

One drenching should be sufficient, however, if some of the lambs fail to respond to the first, they should be given another treatment about 30 days later. Arrangements may be made to have lambs drenched at the market, or even at the range loading point before shipment.

### PREDATORY ANIMALS

Dogs and coyotes constitute a real menace to feeder lambs and sheep in some localities. The danger lies in the fact that their depredations may be sudden and severe and without any warning. The fact that they have not bothered previously is no assurance that they may not start at any time and inflict severe losses.

If feed lots are located some distance from dwellings, it is advisable to take measures for protection before trouble appears. This is true especially when located near town, as dogs seem especially troublesome in such places.

The only way to be sure that dogs and coyotes will not start their ravages in the lamb feed lot is to build the outside fences of the feed lots according to the specifications for wolf-proof fences which are commonly used for pastures in range sheep sections. This type of fence is described elsewhere, under the heading of "Equipment for Lamb Feeding." Such fencing is expensive to construct, but may prove to be an economy in the long run.

Feeders should not fail to take proper precautions for protecting lambs which are running in corn or grain sorghum fields. In sections where coyotes are present, heavy losses may occur. It is well to remember that they usually get in their work early in the morning and in the evening. If lambs are to be turned in the field early and left in late in the day, a close watch should be kept at such time. It is rather exceptional for coyotes to kill sheep throughout the daytime, though they have been known to do so. Cloudy, dark days seem to be favored times for coyotes to work and frequent attention should be given to lambs in fields on such days.

## PART VII

### Shipping Lambs

#### SORTING FOR MARKET

Many times a good job of finishing lambs is partially spoiled at the close by not properly sorting or "shaping up" the shipments of fat lambs to meet market demands. Packer buyers not only want well-finished lambs, but they want large numbers of uniformly finished lambs, also uniform in size and type. This is the only way they can meet their market demands for many carcasses almost identical in size, shape, finish and carcass grade. Every feeder who

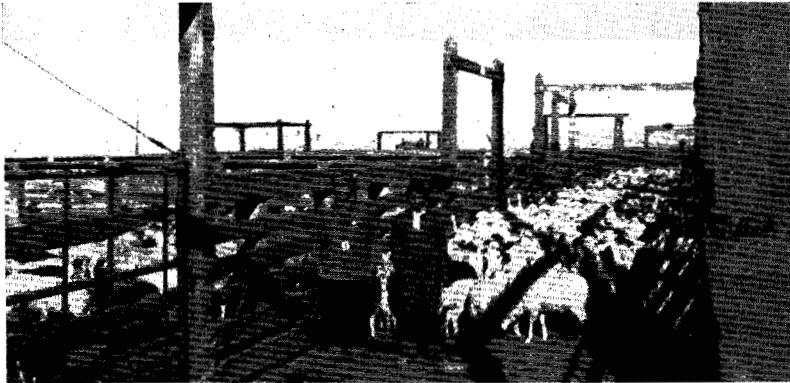

FIG. 43.—Navajo Indian and his son delivering lambs to a range loading point in New Mexico, for sorting and shipment as feeders. This is a good place for the feeder to begin in obtaining uniformity in feeder lambs.

handles a sufficient number of lambs to enable him to sort them at market time should follow at least one shipment of his lambs clear through to the coolers of the packer who buys them, see how the carcasses are graded, what makes the difference between the higher and lower grade carcasses and learn what the packer wants and why he prefers a particular type. Much of value will be learned from this experience, resulting in a better understanding between producer and processor of each other's problems. Unquestionably a thorough knowledge of what is wanted in lamb carcasses will mean increased profits for the feeder, if he will but take advantage of this knowledge by properly sorting fat lambs for shipment.

For these reasons it is evident that uniformity is of utmost importance in buying feeder lambs, especially if only one or two carloads of lambs are to be fed. (See fig. 43.) If a larger number of



lambs is to be fed, uniformity at the beginning of the feeding period is of less importance, since with larger numbers much more selection is possible at market time, enabling the feeder to ship in uniform carload lots.

The buyer is quick to locate lambs in a shipment that appear to be lacking in finish. The buyer always makes a special effort to examine lambs of this kind to determine the fleshing. Feeders occasionally complain that buyers are unnecessarily critical, and examine only the poorest lambs. Whether or not their complaints are justified, it certainly is to the advantage of the feeder to have as few lambs lacking in finish as possible in a shipment. He must there-



FIG. 44.—A well-sorted shipment of fat lambs being held for loading for shipment to market.

fore not depend on his eye or on a straight “gate cut” in marketing. In a reasonably short time two men working together can put the lambs through the cutting chute, one handling their ribs as they walk through, and operating the cutting gate to divide them into two lots; one lot ready for shipment, the other lot to be returned to the feed lot. In the absence of a chute, or even where one is to be used, lambs can be confined in a small space with movable panels to allow for handling each lamb. This method is sometimes followed, even though a cutting chute is available, and the lambs which are finished are marked with colored chalk. This method makes putting the lambs through the chute a more accurate and a shorter job. In any case, each lamb should be handled over the ribs and back and a careful sorting will result in a uniform bunch of well-finished lambs such as those shown in figure 44. It seldom pays to market unfinished lambs.

SAFE LOADING OF CARS

At the time that feeder lambs are bought, some thought should be given to the matter of their shipment to market fat, as well as to the feed lot. A double-deck 36- or 40-foot car can be safely loaded with 300 to 325 average feeder lambs, weighing 60 pounds or less. When the lambs are fat and weigh around 90 pounds, it is not safe to load more than 240 to 260 head in one double-deck car, especially if the haul requires 18 hours or longer. (See figure 45.) It is possible to ship lambs into the feed lot in such numbers that full carloads can be loaded both for the feed lot and later for the market.



FIG. 45.—Feeder lambs being loaded, two decks at a time, in New Mexico and destined for a Kansas feed lot.

Two or three double-deck carloads of feeder lambs will make three or four loads of fat lambs, allowing a normal death loss.

Railroad companies charge for cars for shipping sheep on the basis of 22,000 pounds minimum for double-deck, 36-foot cars or 24,000 pounds minimum for double-deck 40-foot cars. It is always to the advantage of the shipper to load cars at least to their minimum weight if possible, but with feeder lambs, it is impossible to put enough in a car to make up the minimum weight without running the risk of losses in shipment. Fat lambs usually can be loaded safely in sufficient numbers to make up or exceed the minimum weight for which the shipper is charged.

It is a mistake to overload cars. Even if some lambs are not trampled or smothered to death the shipper frequently takes much heavier losses in the form of shrinkage and injured lambs, for which he has no legitimate claim against the carrier. It is an even greater mistake to feed lambs heavily just before loading for shipment—an error that is often made by shippers in an effort to reduce the shrinkage in shipment. Actually livestock thus fed prior to shipment reach the market stale, upset, and generally with a greater shrink than those which receive a lighter than usual feeding before loading. Experienced shippers have learned to avoid “stuffing” livestock before or during shipment to market.

Rough handling, and catching or lifting lambs by the wool should be avoided. The National Livestock Loss Prevention Board has compiled data showing that of all sheep and lambs shipped for commercial slaughter in 1935, 5 percent were bruised, 0.05 percent were crippled, and over 0.10 percent were killed. This represented a loss

each year to the sheep industry of \$455,400. This loss is assessed against the feeder, the carrier, the packer, and the consumer, but in the final analysis the feeder bears most of the loss. A large percentage of this could be avoided by careful handling.

#### THE FEEDING-IN-TRANSIT PRIVILEGE

Because Kansas is traversed by so many railways which lead from points in the range livestock producing states to one or more of the great central livestock markets, feeders in most parts of the state have available to them what is known as the feeding-in-transit rate. This is an arrangement whereby through rates on livestock from the range point of origin to the feed lot for feeding, then on later to market is provided by the railroads. Usually this results in a considerable saving compared with the two "local" billings which would be necessary otherwise. Railroad companies usually limit this privilege to points lying directly between the original shipping point and a market, although frequently it is extended to points on branch lines. It also is limited to interstate shipments. A charge is made for the use of the feeding-in-transit privilege. It is usually 8½ cents per 100 pounds, but may be more, especially if the feeding point is not on a direct line. The through rate at which feeding-in-transit shipments are charged is that which was in effect at the point of origin on the date the shipment was made. This rate applies only on the original weight. The extra weight added by the feeder is charged for at the local rate from the feeding point to market.

Careful figuring in advance by the shipper and the local freight agent or the railway company's general livestock traffic agent will usually result in substantial savings on freight bills.

**The 28-hour Law and the Release.** — In 1906 Congress enacted what is known as the 28-hour law. This law provides that the carrier unload livestock for feed, water, and rest, at intervals not exceeding 28 hours. The exception to this is in cases where the shipper signs a "release" allowing the carrier to haul the shipment for 36 hours before unloading. The purpose of this is to allow shippers to reach the market with their stock without unloading should the haul not exceed the 36-hour limit. Shippers usually take advantage of this privilege, especially when shipping feeder lambs. Fat lambs shrink so much if held on cars too long without feed and water, and the shipping advantages to be gained by using the 36-hour release privilege should be considerable before it is used for shipments of fat livestock. It would generally be advisable only where it permits the shipment to reach the market without unloading.

When no instructions are given railroad employees, they will feed livestock unloaded en route the kind of feeds produced locally as a rule. If any special feed is desired, shippers should give careful and specific instructions to that effect at the time of loading. It is ordinarily desirable to feed lambs the kind and amount of feeds to which they are accustomed, as nearly as possible. It is not usually ad-

visable to feed grain to fat lambs stopped only for a short rest stop en route to market, especially if an attendant does not accompany them. Generally adequate facilities are not available for feeding grain to large numbers of animals, and as a result much of the feed will be wasted, and still worse, some lambs are likely to gorge themselves.

The most frequent mistakes made in shipping lambs to market are overloading of cars and overfeeding just previous to or during shipment. Either is likely to result in stale, unattractive lambs being put on the market, or perhaps some death loss in shipment. Considerable saving can be made by avoiding these two common mistakes.

PRINTED BY KANSAS STATE PRINTING PLANT  
W. C. AUSTIN, STATE PRINTER  
TOPEKA 1940



18-1644