

Skid Steer Loader Safety

For the Landscaping and
Horticultural Services Industry

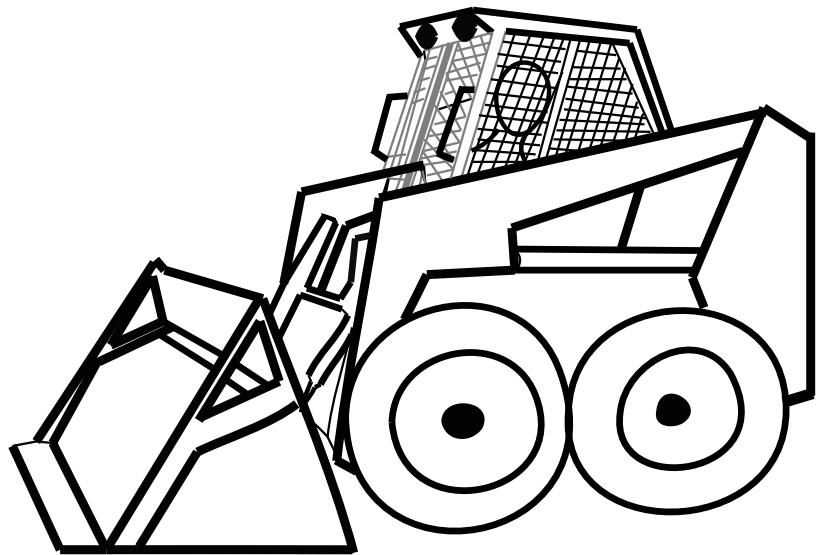

KSTATE Research and
Kansas State University Extension

*“Knowledge
for Life”*

Skid Steer Loader Safety

Contents

Introduction	
What's in This for Me?	3
Lesson 1	
Take Charge of Your Own Safety	4
Lesson 2	
Prepare for Safe Operation	8
Lesson 3	
Don't Get Crushed by Moving Parts	13
Lesson 4	
Prevent Rollover Accidents	17
Lesson 5	
Other Operational Hazards	22
Lesson 6	
Environmental Hazards	27
Conclusion	34
Quiz Yourself Solutions	36

Written by:

Kerri Ebert, Extension assistant

Mitch Ricketts, Coordinator, Health, Safety and Environmental Quality, K-State Research and Extension

Sarah Lind, Information specialist

Disclaimer

This material was produced under grant number 46G3-HT04 and revised and updated under grant number SH-19503-09-60-F-20 from the Occupational Safety and Health Administration, U.S. Department of Labor. It does not necessarily reflect the views or policies of the U.S. Department of Labor, nor does mention of trade names, commercial products, or organizations imply endorsement by the U.S. government.

This booklet was produced by K-State Research and Extension, Kansas State University, Manhattan, Kansas. The information in this publication has been compiled from a variety of sources believed to be reliable and to represent the best current opinion on the subject. However, neither K-State Research and Extension nor its authors guarantee accuracy or completeness of any information contained in this publication, and neither K-State Research and Extension or its authors shall be responsible for any errors, omissions, or damages arising out of the use of this information. Additional safety measures may be required under particular circumstances.

What's in This for Me?

This booklet teaches important safety practices to use when operating or working near skid steer loaders. It is designed to use with hands-on safety training and the equipment operator's manual, not to replace them.

Unsafe work practices injure and kill. This booklet will teach you the dangers of working with a skid steer loader to help you avoid injury or death. We combine safety tips with real accident reports to show how accidents have happened on the job and how they can be prevented.

Lesson 1

Objectives

1. List the two most commonly reported causes of death from skid steer loaders.
2. Interpret the meaning of commonly posted warning signs.

Take Control of Your Own Safety

Greatest Dangers

Skid steer loaders can be dangerous if you do not observe certain safety precautions. Injuries and death are preventable. The most commonly reported causes of serious injury and death using skid steer loaders are:

1. Crushed by moving parts

Accident Report

Operator Crushed Working Under Raised Attachment

NIOSH Accident #3, Publication No. 98-117

After starting a skid steer loader, the operator raised the bucket and then wiggled under or climbed over the safety bar and got out of the cab. Once outside, he leaned into the cab beneath the bucket in front of the loader. Unexpectedly, the bucket lowered, pinned the operator's chest against the frame of the loader and crushed him to death.



Never leave the operator's station when the engine is running or the lift arms are raised.

2. Rollover Accidents

Accident Report

Operator Crushed When Loader Rolls Over

Summary of OSHA Accident Inspection 107225617

A tree had been cut down and the operator was trying to pull it uphill with a skid steer loader. The tree shifted and caused the loader to tip and roll down the hill. The operator was thrown from the cab and crushed to death as the loader rolled over him. The operator was not wearing a seat belt.



When operated improperly, skid steer loaders can overturn, especially handling heavy loads or operating on uneven ground.

Help Yourself

Safe work habits are important. Here are three actions you can take to be safe on the job site.

1. Learn all you can.

To prevent accidents with skid steer loaders, read and follow directions in the equipment operator's manual. Pay attention to safety instructions in the manual and to warning labels you see on the equipment. If you have questions, stop and ask your supervisor before you continue.

2. Concentrate on working safely.

Sometimes you may be tempted to take risky shortcuts. Remember that an accident can leave you permanently injured or cut your life short. For your safety and the safety of those around you, do not take unnecessary risks. No deadline is so pressing you can't take the time to do your work safely.

3. Additional Precautions

Do not operate machinery if you are tired or have taken drugs or alcohol. If you are on medication, discuss with your doctor or pharmacist if you are capable of safely operating machinery.

Accident Report

Operator Thrown From Loader and Run Over

Summary of OSHA Accident Inspection Number 125340379

The operator of a skid steer loader was driving with a load of soil in the bucket. The loader hit a rock and tipped forward, throwing the operator to the ground. The loader ran over the operator and pinned him beneath the front wheels. The operator died at the scene. An investigation showed the safety belt was missing its buckle.



Report any missing or damaged safety equipment to your supervisor

Choose safety

Safety Symbols You May See on a Skid Steer Loader

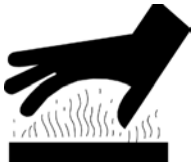

Burn Hazard



Keep hands away from moving machine parts



High pressure fluid can cause an injection injury



Equipment can drop and crush you.



Avoid getting caught in rotating parts

Safety Messages and Signs

Manufacturers put important safety messages on equipment and in the operator's manual. It is critical to read, understand and follow all safety messages.

The triangle shape is the symbol for caution. The exclamation mark in the center means *Pay Attention*. In some instances, the triangle-shaped sign will show a picture. Other times, words explain why the sign is used.

Many safety messages use the words *Caution*, *Warning* and *Danger* to get your attention. Following are safety messages and their meanings. Each of these signs will have a written message, and perhaps a picture, about an unsafe condition.

CAUTION means you need to be careful. Follow the directions on the sign or you could get hurt.

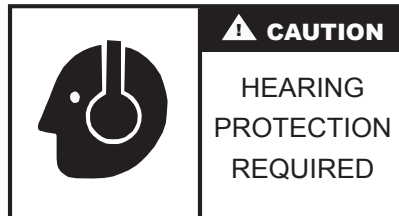

WARNING is more serious and means you need to follow the directions on the sign or you could be badly hurt or killed.



DANGER is the most serious safety message. If you don't follow the directions, you will be seriously injured or killed.

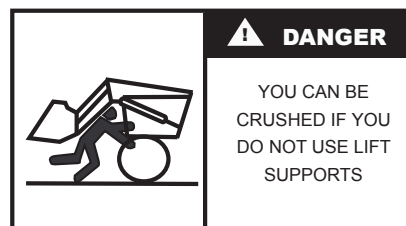

Images displayed in the caution, warning and danger boxes have been recreated from images taken with permission from ASAE S441.3, FEB1999(R2005).

Quiz Yourself

Circle the correct answer.

Answers can be found on page 36.

1. What are the two most commonly reported causes of serious injury and death from operating skid steer loaders?
 - a. Electrocution and traffic collisions.
 - b. Crushing and rollovers.
 - c. Gasoline fires and carbon monoxide poisoning.
2. Match the safety symbol with its meaning.

Falling off a raised attachment can result in serious injury or death.



Keep your hands away from moving machine parts.



You could be crushed by heavy objects that fall, such as a raised attachment.



Lesson 2

Objective

1. Identify and locate safety related features you must check each day before start up.

Prepare for Safe Operation

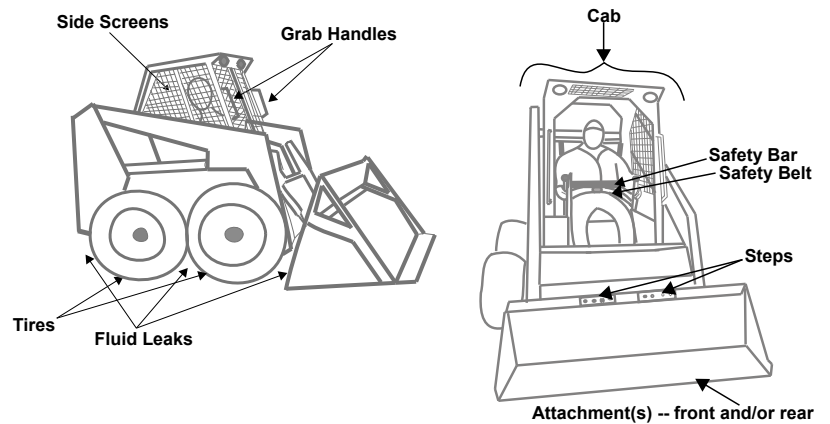

Pre-Start Inspection

Safety starts before the engine. Every day, you should walk around the loader to see that it is ready for safe operation. We've provided a sample checklist for daily, visual, pre-operation inspection. Alert your supervisor before starting the loader if you find anything wrong during your daily check.

Tires

Proper maintenance is important because good tires allow a skid steer loader to perform well on different types of surfaces. Proper tire inflation information will be printed on the sidewall of the tire.

Cab

Some loaders are factory-equipped with side screens, to keep you from getting crushed by moving parts outside the cab. Some cabs are also designed to protect you if the loader rolls over or if material falls onto the cab. If the cab frame or side screens are damaged or appear to have been altered, tell your supervisor and do not operate the loader until a qualified person has determined it is safe.

Safety Belt & Bar

The safety belt and safety bar work together to keep you securely in the driver's seat during operation. Damage to either of these safety devices can lead to serious injury.

Grab Handles

Your hands can easily slip off worn-out grips causing you to fall or lose control of the loader.

Steps

Slips and falls on steps are common and can cause you to engage controls inside the cab if you fall on them. Keep the steps free of ice, mud and debris. When the non-slip step surface becomes worn, it can become slick and should be replaced.

Attachments--Front and/or Rear

Many different attachments are used on skid steer loaders, including buckets, backhoes, augers, chippers, trenchers and pallet forks. Make sure attachments are mounted and fastened correctly. The sudden release of an attachment can cause a load to drop, making the loader unstable and possibly injuring bystanders.

Fluid Leaks

Leaks can cause the loader to break down. Fluids can also be a fire hazard. Puddles of fluid under the loader indicate something is leaking. Report signs of leaking fluid to your supervisor immediately.

Safe Start Up and Shut Down

Entering

Workers are crushed and killed by moving parts when they do not climb into the skid steer loader safely. To prevent accidents, enter according to the manufacturer's instructions.

1. Enter only with the engine off, lift arms down and attachments on the ground.
2. Face the seat with both hands on the grab bars.
3. Never use the control levers as grab bars.
4. Use the steps made for entering.



Pre-Start Checklist

Tires

- Proper inflation?
- No visible damage?

Cab & Side Screens

- Frame damage?
- No unauthorized alterations?
- Side screens attached properly?
- Damage to side screens?

Safety Belt & Bar

- Undamaged?
- Working properly?

Grab Handles

- Non-slip grip undamaged?

Steps

- Free from dirt, clutter, snow, ice, etc.?
- Non-slip surface undamaged?

Attachments — front and/or rear

- Attached correctly?
- Fastened securely?

Fluid Leaks

- No signs of hydraulic fluid leaks?
- No signs of fuel leaks?
- No signs of brake fluid leaks?

Safe Start Up Practices

1. Fasten your safety belt.
2. Lower the safety/restraining bar (if so equipped).
3. Make sure controls are in neutral and the parking brake is set.
4. Clear the area of people.
5. Start the engine.
6. Test all controls.
 - Steering
 - Forward
 - Reverse
 - Raise and lower lift arms
 - Attachment controls
7. Check the brakes.
8. Check the horn and backup alarm (if so equipped).

Choose Safety from the Start

Accident Report

Operator Killed Leaning Head Out Of Cab

Summary of OSHA Accident Inspection 300531282

With the engine running, an operator stuck his head out the side opening of a skid steer loader to check a flat tire. His foot accidentally hit the controls as he leaned out the opening. This caused the lift arm to move, killing him by crushing his head against the hydraulic piston. The opening through which he leaned was originally equipped with a guard, but it had fallen out a few weeks before and had not been replaced.



Never place any part of your body outside the cab where you could be crushed.

- ▶ Never try to start a loader from outside the cab.
- ▶ Never operate the machine if any safety device is missing or damaged.
- ▶ Never climb out of a loader with the engine running.
- ▶ Never start the engine by shorting across the starter terminals.
- ▶ Refer to the operator's manual for instructions on jump-starting if necessary.

Safe Shut Down and Exit

Accident Report

Operator Crushed Exiting Loader With Engine Running

Summary of OSHA Accident Inspection 112410147

After his loader had become stuck in the mud, the operator of a skid steer loader raised the safety bar and tried to climb out of the cab with the engine still running. As he stood up to climb out, his left heel pushed the foot pedal. This raised the lift arms and bucket, which crushed his chest against the cab.



Never exit a skid steer loader with the engine running.

Many operators are killed trying to climb out of the cab without observing safe shut down procedures. Protect yourself by always following these precautions.

1. Park on a level surface.
2. Lower the lift arms and attachments to the ground.
3. Place the controls in neutral.
4. Set the parking brake.
5. Turn the engine off.
6. Cycle the controls to relieve hydraulic pressure.
7. Make sure the controls are locked (if so equipped).
8. Remove the ignition key.
9. Unbuckle the safety belt and raise the safety bar.
10. Exit according to manufacturer's instructions using the steps on the loader and the grab handles for support.
11. Block the wheels if there is a chance the loader will roll.

Quiz Yourself

Draw a line from the word to the parts of the skid steer loader that should be checked every day.

Answers can be found on page 37.

Grab Handles

Cab & Side Screens

Tires

Safety Belt & Safety Bar

Steps

Attachment(s)

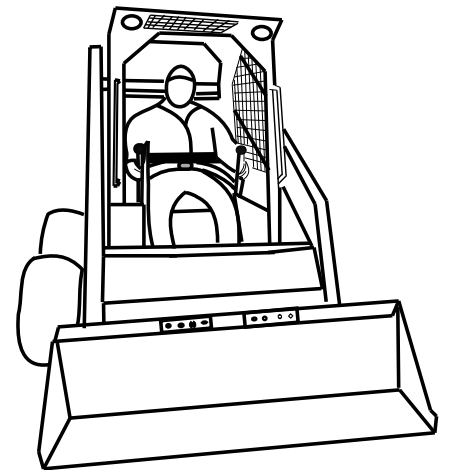
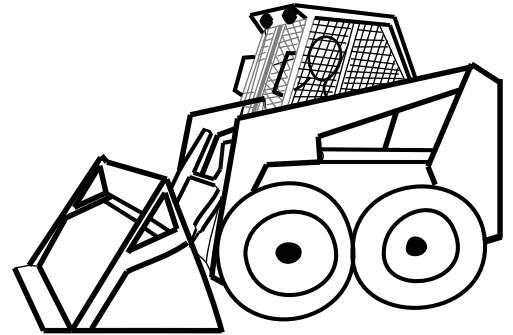

Don't Get Crushed by Moving Parts

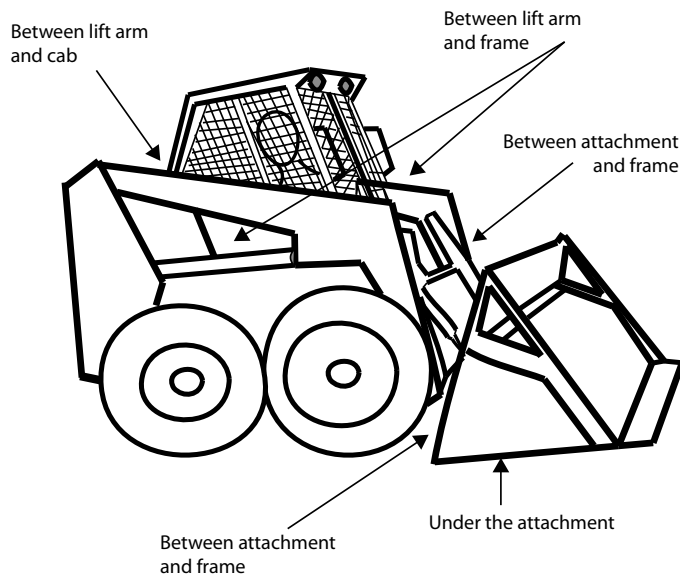

Moving Parts Can Crush You

Being crushed by moving parts is the most commonly reported cause of death when operating a skid steer loader. Crushing accidents happen while entering and exiting, during operation, and when performing maintenance. Even when the loader is equipped with interlocks, those interlocks are not fool proof. People are killed in ways that cannot be prevented by interlock systems.

Accident Report

Operator Crushed by Moving Parts

Summary of OSHA Accident Inspection 300582855

The operator of a skid steer loader was preparing to move some logs. While standing outside the loader, he reached into the cab to operate the controls. When the bucket began to move, the operator was crushed to death between the hydraulic arm and the frame of the loader.



Never operate a skid steer loader from outside the cab.

Lesson 3

Objectives

1. Recognize how moving parts can crush you.
2. Identify safe work practices that protect you from being crushed.

How To Avoid Being Crushed

Accident Report

Employee Killed Working Under Unsupported Lift Arms

Summary of OSHA Accident Inspection 300201944

Two employees were draining hydraulic fluid from a skid steer loader. They raised the bucket so one employee could get his head between the lift arms and the engine housing. The other employee then removed the plug on the hydraulic reservoir. The hydraulic system lost pressure as the hydraulic fluid drained causing the unsupported lift arms to come down and crush the head of the first employee against the engine housing.



Always use approved lift arm supports.

1. Never enter or exit under a raised attachment because it could fall on you.
2. Never start the engine or operate controls from outside of the cab. The loader or lift arm attachments can move and crush you when the controls are engaged.
3. Always fasten your safety belt and lower the safety bar when you are in the operator's seat so you stay securely in the cab, protected from being crushed.
4. Never climb into or out of the cab while the engine is running. You can be crushed if you bump the controls.
5. Never lean out of the cab while the engine is running. Keep your head, arms and legs inside or you can be crushed by moving lift arms or attachments.
6. Never lift an attachment above a person. Loads can shift or fall out, or the attachment can drop unexpectedly, crushing anyone under it.
7. Never lift loads so high or roll attachments back so far that material dumps into the cab, landing on you.

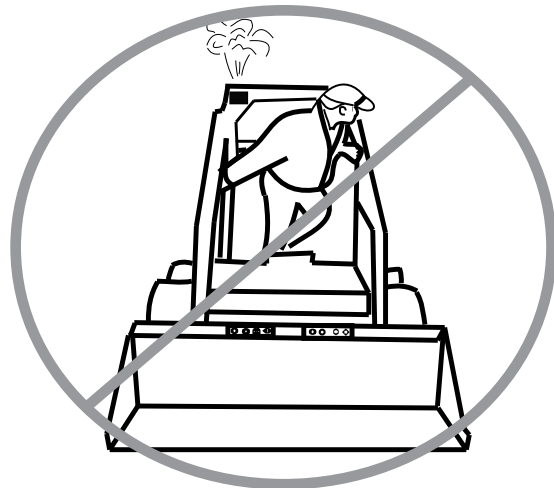

8. Never work under a raised attachment, unless the lift arms are secured in the “up” position using approved lift arm supports. Contact the manufacturer for information if your loader does not have lift arm supports.
9. Whenever possible, perform maintenance work with the engine off, key removed, parking brake set, wheels blocked and attachments lowered or supported by an approved lift arm support.

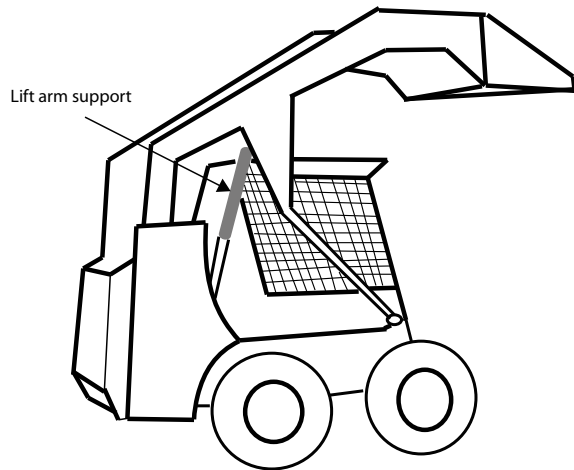

Quiz Yourself

Answers can be found on page 38.

1. Draw a line from the words to the areas on the loader where you or someone else could be crushed by moving parts.

Outside of the windows/
side screens

Between the lift and frame

Between lower front frame
and front tires

Step area

Under the attachment

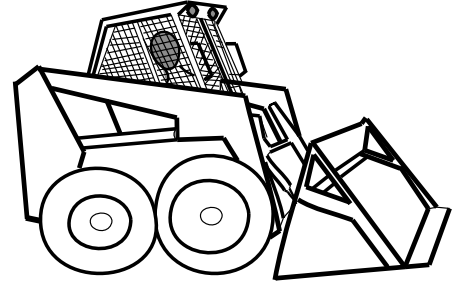

2. When the engine is running, the safest place for you is _____.

- a. Riding in the bucket
- b. Standing next to the loader
- c. Sitting in the operator's seat with the safety belt fastened and the safety bar in place

3. Circle the drawing that best shows the operator working safely in a skid steer loader with the engine running.

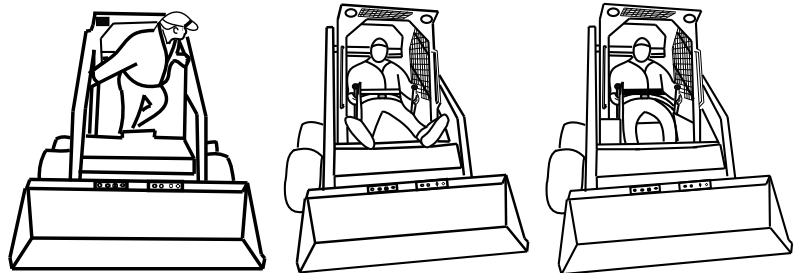

Use the list of words below to complete the sentences.

Attachment

Move

Body

Engine

5. Never start the engine by shorting across starter terminals. You could be crushed if the loader starts to _____.
6. Never work or walk under a raised _____.
7. Never get in or out of the loader with the _____ running.
8. Do not lean any part of your _____ out of the cab with the engine running.

Prevent Rollover Accidents

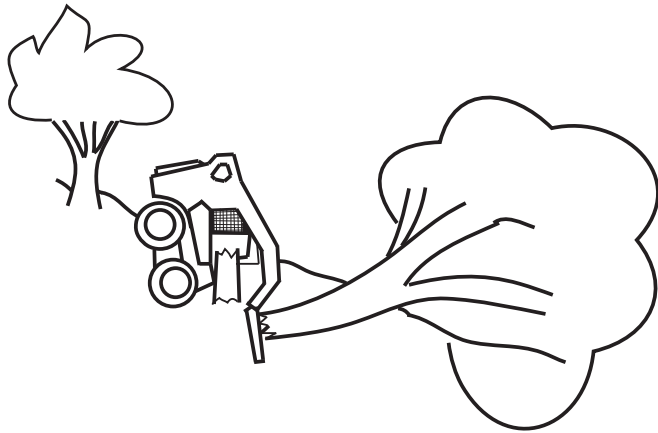

Think about what could have happened to cause this accident. It will be discussed on page 20.

Prevent Rollovers

When a skid steer loader becomes unstable or out of balance, it tips over. Overloading, carrying loads too high, operating on rough or uneven surfaces, adding attachments or driving too fast for conditions cause the loader to become unstable.

Human reaction time is too slow to stop a rollover once it starts. You can avoid rollovers by recognizing dangerous situations and taking action to avoid them.

Accident Report

Worker Rolls Loader Over Retaining Wall

Summary of OSHA Accident Inspection 107227480

An employee was spreading topsoil with a skid steer loader near the edge of a six-foot concrete retaining wall drop-off. As he backed the loader toward the wall, the left rear tire went over the edge and the loader rolled over the drop-off to the ground below. The operator was not wearing his safety belt and was killed.



Stay away from steep edges when operating a skid steer loader.

Lesson 4

Objectives

1. Identify safe work procedures to avoid rollover accidents.
2. Describe what could happen when safety procedures are not followed.

Accident Report Skid Steer Loader Tips Forward, Injures Operator

Summary of OSHA Accident Inspection 119530798

A skid steer operator was dumping gravel and dirt at a basement foundation. He wanted to throw the material farther into the excavation, so he raised the bucket and jerked the loader causing it to bounce. The loader tipped forward and landed on the foundation wall, pinning the employee's legs between the loader and foundation. He suffered a broken leg and other injuries.



Operate all controls smoothly.

Avoid Rollover Accidents

- ▶ Don't overload the attachment. Check the capacity label, data plate, or operator's manual for the maximum load limit. Exceeding that limit may cause the loader to become unstable and roll over.

Sample data plate

RATED OPERATING CAPACITY	
700 kg	1700 lbs
FAHRBARE NUTZLAST	
CAPACIDAD DE OPEATION	
CAPACITE MAXIMUM LEVANGE	
SW 95 6561376	

- ▶ Evenly distribute the load on the attachment so the loader doesn't tip over.
- ▶ Secure unstable loads so they won't shift or fall. When securing is necessary, lower the lift arms, shut off the engine, climb out, chain the load in place, climb back in the cab, start the loader and proceed with the job.
- ▶ Lift loads slowly and evenly to keep the loader stable.
- ▶ Carry loads close to the ground, yet high enough to clear obstacles. When a load is carried too high, skid steer loaders are more likely to tip. It is especially important to carry the load as low as possible when turning, carrying a heavy load, travelling on a slope, or operating on rough surfaces.
- ▶ Keep the attachment level while moving lift arms or driving up and down hills, otherwise the load could shift and make the loader out of balance.
- ▶ Operate at a speed that is appropriate for conditions so you don't lose control of the loader.

- ▶ Operate the controls smoothly to prevent jerking or bucking.
- ▶ Operate on level, stable surfaces. Load, unload and turn on solid, level ground.
- ▶ Drive up and down hills, not across them. Drive slowly on slopes.
- ▶ Keep the heavy end of the loader pointed uphill. When fully loaded, skid steer loaders should be driven with the load uphill. When unloaded, the rear of the loader is heavier, so the back of an empty loader should be pointed up hill. If you are not sure of which end is heaviest because of added attachments, check the operator's manual.
- ▶ Do not make sharp turns on hills or the loader may roll over. Stay away from steep hills entirely. The operator's manual defines the maximum slope for your loader.
- ▶ Avoid holes, large bumps, soft spots and weak floors. All can make the loader unstable.
- ▶ If you must cross railroad tracks, ditches, curbs or similar rough surfaces, cross at an angle and drive slowly.
- ▶ Stay away from steep edges on loading docks, ramps, ditches, retaining walls and near trenches; otherwise you could fall over the edge or the bank could cave in.

Accident Report

Floor Collapses, Kills Skid Steer Operator

Summary of OSHA Accident Inspection 102907219

The operator of a skid steer loader suffered a broken neck and died when his loader fell twenty feet through the second story floor of a structurally unsound building.



Always work on stable surfaces and avoid weak floors.

Carry loads as low to the ground as possible to avoid a rollover.

YES

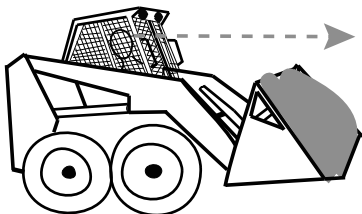

NO

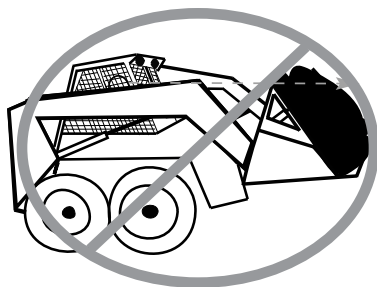

Here's What Happened

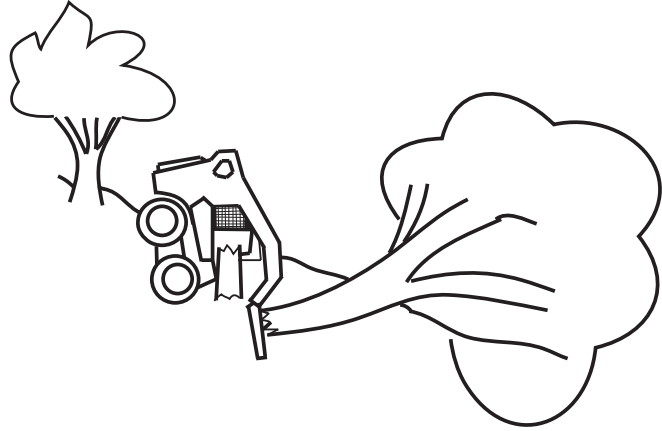

Summary of NIOSH FACE Report, No. 01IA04201

The operator was using a tree shear attachment to clear trees on a steep hillside. With the attachment raised about four feet above the ground, he tried to cut a branch that was larger than the capacity of the shear. The weight of the falling branch tipped the loader forward onto the tree stump, pinning the operator between the loader and stump, killing him instantly.

What he did wrong:

1. He exceeded the capacity of the attachment. The tree was too big and too heavy for the loader.
2. The lift arms were raised when he made the cut. The owner's manual said the attachment was for ground use only.
3. The hill was too steep to keep the loader stable.

Can you think of other mistakes?

Quiz Yourself

Circle the picture where the operator is working correctly.

Answers can be found on page 39.

1.

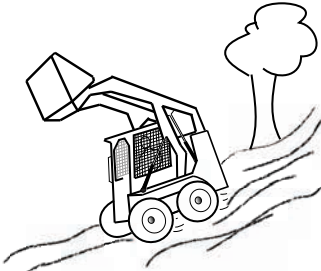

Driving down hill with the attachment up.



Driving on level ground with the attachment low.

2.

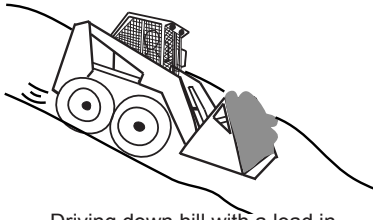

Driving down hill with a load in the bucket.

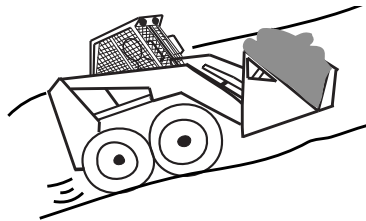

Driving up a hill with a load in the bucket.

3.

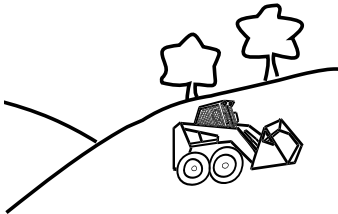

Driving across a hill with the loader empty.

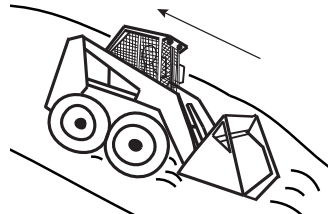

Backing up a hill with the loader empty.

4.

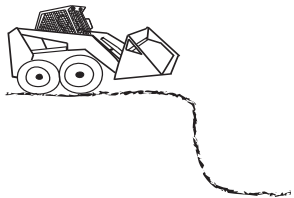

Driving a safe distance from a ditch.

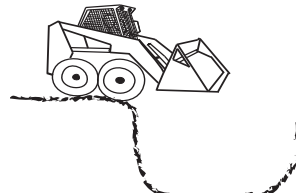

Driving to the edge of a ditch.

Use the list of words below to complete the sentences.

- a. Turns
- b. Smoothly
- c. Angle

- 5. When it is necessary to drive across railroad tracks, slow down and cross at an _____.
- 6. Do not make sharp _____ on hills.
- 7. Operate the loader _____.

Lesson 5

Objectives

1. Describe how to avoid collisions with obstacles, traffic and people.
2. Identify dangers from electricity, carbon monoxide, fuels and other fluids as well as falling material.

Other Operational Hazards

Deadly accidents involving skid steer loaders are not limited to crushing and rollovers. Other dangers include: running over yourself or others, running into obstacles, traffic accidents, electrocution and poisoning caused by carbon monoxide, fuels or fluids.

Accident Report

Worker Run Over Reaching Into Skid Steer Loader

Summary of OSHA Accident Inspection 300076684

A worker who needed to get his gloves from the cab of the loader, approached the driver. With the driver in the cab and the engine running, the worker reached in, grabbed his gloves and accidentally moved the drive control lever. The loader moved forward and to the left, running over him and crushing his head and shoulders between the front tire and frame.



Never reach into the cab when the engine is running.

Steer Clear of Runover Accidents

- ▶ Wear your safety belt and use the safety bar so you stay safely inside the cab.
- ▶ Know where your coworkers are. Check all around before moving the loader. Keep other people away while you are operating and never let anyone get close enough to be crushed by unexpected loader movements.
- ▶ Drive forward when you are on level ground unless the load blocks your view or the attachment is designed to be used with the loader in reverse. When a load blocks your view, either drive in reverse (if the loader is designed so you can see behind) or have a coworker guide you. Work out hand signals in advance. Make sure your coworker stays a safe distance from the loader.
- ▶ Watch for traffic and pedestrians when crossing or working near roads, driveways, parking lots, building corners, shrubs, trees and other blind spots. People, animals and traffic move quickly and may not realize they are in the path of danger. Be aware of your surroundings at all times.

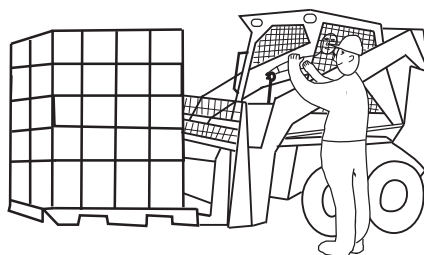

A coworker can help you move loads that are too high and wide to safely see over and around.

- ▶ Look in the direction you are driving.
- ▶ Operate the loader smoothly to maintain control so you don't injure yourself or others nearby.
- ▶ Don't ram the attachment into materials. You might:
 - Run into an object hidden by the material.
 - Run through the pile and hit someone or something on the other side.
 - Lose control of the loader.
- ▶ Never allow riders. The cab is built for one person and attachments are not for carrying people.
- ▶ Prevent the loader from moving unexpectedly during maintenance.
 - Park on a level surface.
 - Lower the attachment(s).
 - Place the controls in neutral.
 - Set the parking brake.
 - Turn the engine off.
 - Cycle through the controls to relieve hydraulic pressure.
 - Follow safe shut down procedures so controls are locked.
 - Block the wheels so that loader will not roll.

Stay Away from Obstacles

Accident Report

Operator Killed When Limb Penetrates Cab

Summary of OSHA Accident Inspection 103543476

An employee was using a skid steer loader to clear dense weeds, brush and dead trees from a woodland lot. He was moving a brush pile when the loader ran into a dead limb that came through the front of the cab and struck him on the left side. The limb broke one of his ribs and punctured his heart. He was killed.



Check the work area before you begin.

- ▶ Check the work area before you start. Note all potential obstacles--tree branches, pipes or any object that could come through the cab. Make sure you have adequate clearance through aisles, doorways and other openings.
- ▶ Maintain a clear line of sight. Keep the windshield and the back window clean, if the loader has them.
- ▶ Keep attachments and loads as close to the ground as possible so they don't block your view.
- ▶ Use extra caution indoors. Loaders respond quickly to their controls. It's easy to run into walls, overhead doors or pipes.

Fill Fuel Containers Correctly

To reduce the chance of static sparks, do not fill containers (plastic or metal) in a car or the bed of a pickup.

1. Always shut off the engine before refuelling.
2. Touch the fuel nozzle to the container before removing the container lid.
3. Keep the nozzle in contact with the container while filling.
4. Don't fill to the brim. Leave room for expansion. Containers and gas tanks should be filled 3/4 full.

Beware of Undercutting

Digging into the bottom of a material pile is called undercutting. The overhang created by an undercut can collapse.

- ▶ Do not work with material piles that are taller than your raised attachment.
- ▶ Work from the top down, shaving material from the front of the pile so it will not collapse.

Dangers of High Pressure Hydraulic Fluid

Hydraulic fluid flows through hoses under very high pressure. Leaks from a thin, high-pressure stream that quickly cuts through skin causing serious injury. Never use your hand to check for a hydraulic fluid leak. If you think there is a leak, have it checked by someone who is qualified to check for hydraulic fluid leaks.

Carbon Monoxide Kills!

Indoor work sites require fresh air ventilation. Gasoline-, diesel- and LP gas-powered loaders produce carbon monoxide (CO), a deadly, odorless, colorless gas. CO can poison you before you realize it. Symptoms of CO poisoning include headache, nausea, weakness, dizziness and loss of consciousness. When working indoors, if anyone has these symptoms, shut down the loader, get everyone out of the building and call 911.

Accident Report

Warehouse Workers Poisoned by Carbon Monoxide

Summary of NIOSH FACE Program Report Number 2000-15

Five employees were working inside a warehouse using gasoline-powered equipment, including a skid steer loader. Because it was cold outside, the overhead doors were closed except to let the skid steer loader in and out. After a few hours, they all began to experience headache, nausea and dizziness. All five were taken to a local hospital where tests showed they had been overexposed to carbon monoxide.



Carbon monoxide kills!

Use Caution Near Gasoline and Fuels

Gasoline and other fuels are flammable.

- ▶ Always shut off the engine before refueling.
- ▶ Never smoke or allow open flames near fuel.
- ▶ Check the operator's manual for correct fueling guidelines.
- ▶ Touch the fuel nozzle to the loader before opening the fuel cap to reduce the chance that a static spark will ignite the fuel. Keep the nozzle in contact with the filler neck while fueling. Replace the cap as soon as you are finished.
- ▶ Use only approved fuel containers.
- ▶ Never clean your hands or machine parts with gasoline. Use a nonflammable solvent instead.

Guard Against Electrocution

High voltage electricity can jump several feet away from a power line and travel through metal, wood, vegetation and many other materials. Talk with your supervisor before starting on a job that requires work near any electric power source.

- ▶ Call your state's one-call utility location hotline to identify buried lines before digging. The phone number will be in the information pages in the front of the phone book.
- ▶ Don't carry tall loads near power lines.
- ▶ Keep the attachment as low as possible when working near overhead lines.
- ▶ Don't drive over downed or exposed power lines.

Prevent Accidents Near Traffic

A skid steer loader is not made for street or highway travel. To be safe, load it onto a trailer and pull it to job sites. When the loader must be moved short distances on a public roadway, keep the following safety tips in mind.

- ▶ Lock attachments in the transport position.
- ▶ Observe all traffic signals, signs and rules.
- ▶ Mount a Slow Moving Vehicle (SMV) emblem on the back to indicate the loader is moving at a speed less than 25 m.p.h.
- ▶ Use caution at intersections. Allow faster moving vehicles to go first. Make sure you have enough time to get through safely, without interrupting traffic flow.
- ▶ Do not drive at night unless the loader is equipped with lights as required by state law.
- ▶ Use a flagger and highly-visible warning cones to alert oncoming traffic when working near a public roadway. Locate flaggers and cones far enough ahead of the work site so drivers have time to slow down.
- ▶ The skid steer operator and the flagger should wear highly visible, reflective clothing.
- ▶ Do not park the loader on a public roadway. It creates a hazard for you and motorists. Park away from the road on a level surface if the loader must be left at a job site.
- ▶ Check the operator's manual for instructions before hauling the loader on a trailer.

If The Loader Contacts an Electrical Source:

- ◆ Remain calm.
- ◆ Follow safe shutdown procedures.
- ◆ Stay in your seat or you could be electrocuted.
- ◆ Shout for someone to call the power company.
- ◆ Keep people away from the machine or they too could be electrocuted.
- ◆ Wait until the power has been disconnected to get out of the loader.

Safely Drive a Loader On a Trailer

- ◆ Keep bystanders at a safe distance while loading.
- ◆ Select a level surface.
- ◆ Block the wheels of the transport vehicle and the trailer.
- ◆ Use a ramp that can safely accommodate a skid steer loader.
- ◆ Back the loader up the ramp to keep the heavy end uphill. This helps prevent roll-overs.
- ◆ Drive forward down the ramp.
- ◆ Set the parking brake, chain and block the loader so it won't move during transport.

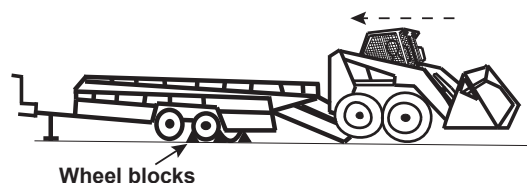

Quiz Yourself

Circle the picture where the operator is working correctly.
Answers can be found on page 40.

1.



BACKING ONTO A TRAILER.



DRIVING ONTO A TRAILER.

2.

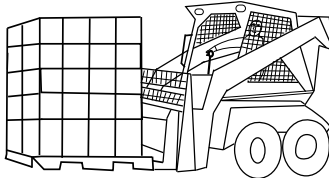

DRIVING WITH A LOAD BLOCKING
YOUR VIEW.

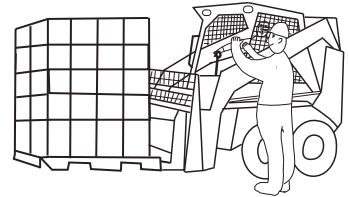

USING A COWORKER TO HELP YOU
MOVE A LARGE LOAD.

3.

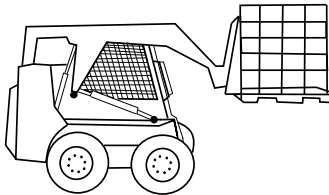

CARRYING A LOAD HIGH OFF THE GROUND.



CARRYING THE ATTACHMENT AS LOW TO
THE GROUND AS POSSIBLE.

Use the list of words below to complete the sentences.

- a. Undercutting
 - b. Deadly, odorless, colorless
 - c. Leak
4. Gasoline-, diesel- and LP gas-powered skid steer loaders produce carbon monoxide (CO), a _____ gas.
5. Ask someone who is qualified to check for a hydraulic fluid _____.
6. _____ can cause a material pile to collapse on you.

Environmental Hazards

Heat Stress

You can become seriously ill or die if you do not take the proper precautions while working in high temperatures and humidity. Heat can reduce physical performance, as well as mental alertness, causing more accidents.

Heat Facts

- ▶ You are more likely to suffer from a heat related illness on humid days.
- ▶ If you are not used to working in the heat, you are more likely to suffer from a heat related illness. It can take your body anywhere from 5 days to 2 weeks to be acclimated to working in the heat. It is recommended that new workers who begin in hot, humid weather, start out by working half of the normal time and workload on the first day and then build up to a complete day by the end of the week.
- ▶ You are more vulnerable to heat illness if you have suffered in the past.
- ▶ During the course of the day, you can produce as much as 2 to 3 gallons of sweat. Replenish this fluid by drinking liquids so that you do not suffer from a heat related illness.

Lesson 6

Objectives

1. Identify environmental hazards.
2. Recognize treatment and first aid for exposure to environmental hazards.

Heat Exhaustion Symptoms

Heat exhaustion is a serious illness and needs to be treated immediately before a heat stroke occurs. If you or a coworker experience any of the following symptoms, cool off immediately and drink plenty of water.

- Dizziness
- Light headedness
- Headache
- Feeling weak, fatigued
- Clammy and moist skin

Heat Stroke Symptoms

Heat Stroke is a medical emergency that can become fatal. If anyone experiences the following symptoms of heat stroke, call 911 immediately.

- Hot, dry, red skin (not sweaty)
- Disorientation
- Confusion
- Body temperature greater than 105° F
- Convulsing
- Unconsciousness

What to Do If Someone's Suffering from a Heat Illness

- ▶ If someone feels overheated, move them into a cooler, preferably air conditioned area. Watch the person and seek medical attention if needed.
- ▶ Fan the person in order to increase cooling.
- ▶ Have the person drink plenty of fluids.
- ▶ If the person goes into convulsions or shows symptoms of heat stroke, call 911 immediately and take steps to cool them down such as soaking their clothing in cool water.

Avoid Heat Related Illnesses

It is important to keep yourself hydrated and cool while working outside.

- ▶ Drink water often throughout the day; don't wait until you're thirsty to get a drink. At least a quart of water per hour is recommended.
- ▶ Stay away from soda, coffee, tea and alcoholic drinks that dehydrate the body.
- ▶ Avoid large meals before working in the heat.
- ▶ Some prescriptions can make you more susceptible to heat illnesses. Check with your doctor or pharmacist to see if any medicine you are taking could affect you while working in the heat.
- ▶ Wear light-weight fabric, such as cotton, to help keep your body cool.
- ▶ Wear a hat or sun visor on sunny days to help control body temperature.
- ▶ Plan to do the heaviest work at the coolest part of the day. This is usually between 6 a.m. and 10 a.m.
- ▶ Take frequent, short breaks in shaded areas to cool down.
- ▶ Do not take salt tablets, unless recommended by your doctor. Most people receive enough salt in their diet to account for the salt that is lost through sweating.

Sun Exposure

Prolonged exposure to sunlight causes skin cancer, cataracts and other serious illnesses.

- ▶ Choose a sunscreen that is marked broad-spectrum. This will protect you from both UVA and UVB rays. Ensure the Sun Protection Factor (SPF) is at least 15.
- ▶ Wear a hat or sun visor, sunglasses, and lightweight long-sleeve shirts and pants on sunny days to help control body temperature and block the sun.

Lightning Precautions

Lightning strikes injure and kill hundreds of people each year. Follow these precautions to help keep you safe when the weather turns bad.

- ▶ As soon as you hear thunder, shut off and put away equipment and move indoors out of the storm. When you are able to hear thunder, you are able to be struck by lightning. Lightning can strike even when it's not raining.
- ▶ The cab of an enclosed vehicle provides some protection from lightning but a sturdy building provides the best protection.
- ▶ Listen to the radio for weather updates and storm warnings.

If You Can't Take Cover Inside

- ▶ Get to a low space. Lightning strikes the tallest objects.
- ▶ Crouch down on the balls of your feet. Place your hands on your knees and lower your head between your knees.
- ▶ Minimize contact with the ground.
- ▶ Do not lie flat on the ground. This will make you a larger target.

Keep Away From

- ▶ Large, lone trees and towers, fences, telephone poles and power lines.
- ▶ Rivers, lakes, pools and other bodies of water.
- ▶ Metal objects, tools, equipment, wire fences and umbrellas.

If Someone is Struck by Lightning

- ▶ Call 911
- ▶ Check to see if they're breathing. Rescue breathing or CPR may be required.
- ▶ Check for burns on their body.
- ▶ Move the victim inside, out of the storm.
- ▶ **Note:** Most lightning-strike victims survive with immediate treatment and rescue breathing or CPR.

Lightning Facts

- ▶ A person that is struck by lightning **DOES NOT** retain an electric charge that can shock you.
- ▶ Lightning can spread as far as 60 feet after striking the ground.
- ▶ Lightning can travel at speeds of 100,000 mph.
- ▶ The temperature of a bolt of lightning can be as high as 50,000° F.
- ▶ Lightning **CAN** strike the same place twice.

What to Do If Someone's Suffering from a Cold-Induced Injury or Illness

- ♦ Move the person out of the cold and into an area that is warm and dry.
- ♦ Remove wet and tight clothing and cover the person with a blanket.
- ♦ Never rub the affected area. This will cause further skin and tissue damage.
- ♦ Seek medical attention immediately.

Cold Induced Injuries and Illnesses

Prolonged exposure to freezing temperatures can result in cold-induced injuries and illnesses that can seriously injure or kill you.

Cold temperatures reduce mental alertness and cause fatigue and exhaustion that can lead to accidents.

Frostbite

Frostbite occurs when parts of the body become so cold that the skin and tissue freezes. Frostbite normally occurs on ears, nose, fingers, hands, toes and feet or other parts of the body that are left uncovered in below-freezing temperatures. Frostbitten skin becomes numb and turns a pale white color.

Hypothermia

Hypothermia occurs when a person's body temperature drops to or below 95° F. Common symptoms include bluish-colored skin, uncontrollable shivering and drowsiness or fatigue.

Avoid Cold-Induced Injuries and Illnesses

- ▶ Layer clothing when working in cold temperatures; you can easily take off layers if you are too warm.
- ▶ Wear a hat and gloves.
- ▶ Keep muscles warm and loose by moving as much as possible.
- ▶ Take frequent, short breaks in warm areas.
- ▶ Perform work at the warmest part of the day, typically in the afternoon.
- ▶ Never work alone.

Insect Stings

Insect stings can be treated without medical attention unless the person suffers an allergic reaction.

The first step to treating an insect sting is to remove the stinger. This can be done by using a straight edge to scrape off the stinger or by using tweezers to pull it out. If you choose to use tweezers to remove the stinger, use extreme caution to not puncture the protruding venom sac.

After the stinger has been removed, a cold pack can be used during the first 24 hours to suppress pain and swelling. Following the first 24 hours, heat should be applied if pain or swelling persist.

Those with severe allergies to insect stings should consult a physician about carrying a prescription medical kit. The kit contains medicine and instructions to be used if the person is stung. If the kit is used, the victim still must receive medical attention. Call for help or take them to the nearest hospital.

Snake Bites

If you are bitten by a snake, seek medical attention immediately and try to describe the size and color of the snake to the doctor. This can help the doctor determine whether or not the snake was poisonous.

Never cut, suck or apply cold packs to snake bites.

Mammals

Be aware of animals such as squirrels or bats that may be in trees or bushes and startle you during work. Also, be cautious of animals such as rats, skunks and raccoons that could be rabid.

Poison Ivy, Oak and Sumac

- ▶ Wash the affected area and all clothing and tools that may have touched the plant.
- ▶ Avoid scratching the area if possible, to prevent infection.
- ▶ Hot and cold compresses can be used to suppress itching.
- ▶ Consult a doctor if the rash is on the face, inside the mouth or covers a large portion of the body.

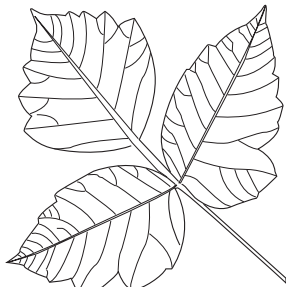

Poison Ivy

Leaves are usually
found in clusters of three.

Treating Cuts and Burns

Minor cuts and burns can be treated on the job site.

Seek medical attention if:

- ▶ Cuts are severely bleeding, more than one-half inch long and one-quarter inch deep, or the result of a puncture wound.
- ▶ Burn area covers more than one-fifth of the body with blisters, blisters occur on the hands, feet, face or genitalia, or if the skin is blackened or charred.

Treating Cuts

- ▶ Clean the area thoroughly.
- ▶ Remove any debris that may be in the wound.
- ▶ Apply pressure to the wound using gauze or a clean, absorbent cloth until the bleeding stops. If blood seeps through the cloth, do not remove it, continue adding more gauze or cloth over the previous one.
- ▶ Apply an antibiotic ointment and cover with a bandage or clean gauze.
- ▶ Allow wound to heal and keep dirt from creating infection by changing the bandage or gauze frequently.
- ▶ If a limb has been amputated, elevate while applying direct pressure and call 911.

Treating Burns

- ▶ Cool the burn by placing it under cool running water or in a container of cool water for at least 15 minutes.
- ▶ Cover the area with gauze or a clean cloth.
- ▶ Allow burn to heal and keep dirt from creating infection by changing the gauze frequently.
- ▶ If blisters occur, do not break them. Cover with gauze and allow them to break on their own.

First Aid Kit Contents

The following is a list of minimum requirements for workplace first aid kits as outlined by ANSI Standard Z308.1-2003*.

- ▶ absorbent compress
- ▶ adhesive bandages
- ▶ adhesive tape
- ▶ individual-use antiseptic applications
- ▶ individual-use burn treatment applications
- ▶ latex-free medical exam gloves
- ▶ sterile pads
- ▶ triangular bandage

*ANSI Z308.1-2003 is published by the International Safety Equipment Association, Arlington, VA www.safetysafetyequipment.org. Used with permission.

Quiz Yourself

Circle the correct answer.

Answers can be found on page 41.

1. Stop a cut from bleeding by applying _____.
 - a. Aloe
 - b. Ointment
 - c. Direct pressure
2. Dizziness, light headedness, headache and fatigue are all symptoms of _____.
 - a. Lightning strike
 - b. Heat exhaustion
3. It is important to take frequent, short _____ when working outside.
 - a. Strides
 - b. Phone calls
 - c. Breaks
4. To keep hydrated when working outside, drink _____.
 - a. Water frequently throughout the day
 - b. Only when thirsty
 - c. Soda at lunchtime
5. Lightning strikes the _____ objects.
 - a. Tallest
 - b. Widest
 - c. Shortest

Select the correct answer for the following sentences from the list below.

- a. Immediately
 - b. Stinger
 - c. Wash
 - d. Frostbitten
 - e. Lower
6. Never rub a body part that has been _____.
 7. The first step to treating an insect sting is to remove the _____.
 8. If you contact poison ivy, oak or sumac, _____ the affected area as well as all clothing and tools.
 9. Hypothermia occurs when body temperature drops to 95° or _____.
 10. If a person with a known allergy to insects is stung, call for help _____.

Conclusion

Skid steer loaders can be dangerous. Safe work habits before, during and after operation are important to prevent accidents on the job. You have been presented with checklists, safety tips and exercises designed to help you avoid the most commonly reported causes of skid steer loader operation deaths. Use this information to keep your work experience safe.

Quiz Yourself

Read the following accident report to answer the following questions. Use the list of words below to fill in the blanks.

Answers can be found on page 42.

- a. experience
- b. team
- c. cab
- d. support

Accident Report

Supervisor Crushed Between Lift Arms and Frame

Summary of NIOSH FACE Program Report Number 2000-15

An inexperienced employee was learning how to operate a skid steer loader. He began having trouble and told the production supervisor he thought there was a hydraulic problem. After the employee raised the lift arms, the production supervisor stepped under the attachment to check for a hydraulic leak. After some discussion, the supervisor reached out and moved the lift control lever with his hand. This caused the lift arms and attachment to come down on the supervisor, pinning him against the front chassis of the loader. The supervisor was pronounced dead at the scene.

1. The supervisor stepped under a raised attachment without an approved lift arm _____ in place.
2. The supervisor operated the controls from outside the _____.
3. The employee did not have enough _____ to help the supervisor troubleshoot the loader with the engine running.
4. Since the engine was running, the troubleshooting should have been performed by two experienced employees working as a _____.

You are responsible for parking the skid steer loader at the end of the workday. Use the words below to fill in the blanks in this list to tell how you should shut down safely so the loader doesn't move after it's parked.

- e. Shutdown
 - f. Attachment
 - g. Block
5. Lower the _____.
 6. Follow safe _____ procedures as outlined in the operator's manual.
 7. _____ the wheels.

Quiz Yourself

Solutions

Lesson 1

Circle the correct answer.

1. What are the two most commonly reported causes of serious injury and death from operating skid steer loaders?
 - a. Electrocution and traffic collisions.
 - b. Crushing and rollovers.
 - c. Gasoline fires and carbon monoxide poisoning.

2. Match the safety symbol with its meaning.

Falling off a raised attachment can result in serious injury or death.

Keep your hands away from moving machine parts.

You could be crushed by heavy objects that fall, such as a raised attachment.

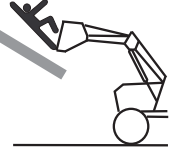

Lesson 2

Draw a line from the word to the parts of the skid steer loader that should be checked every day.

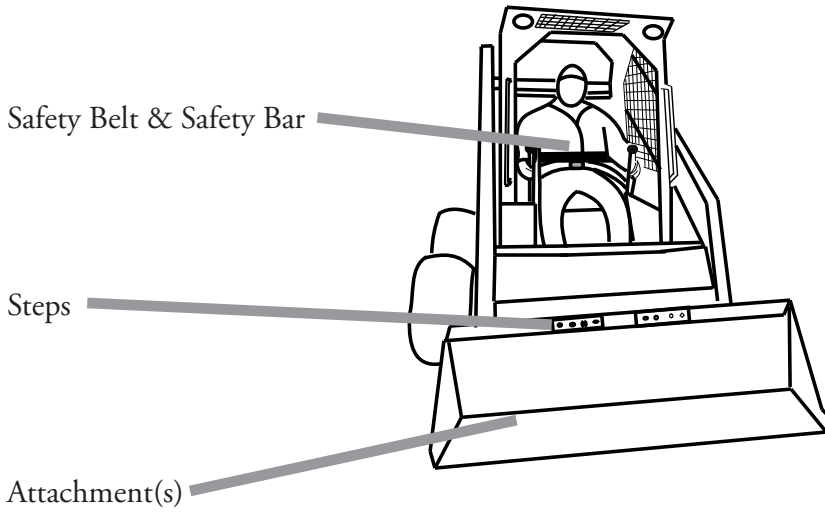
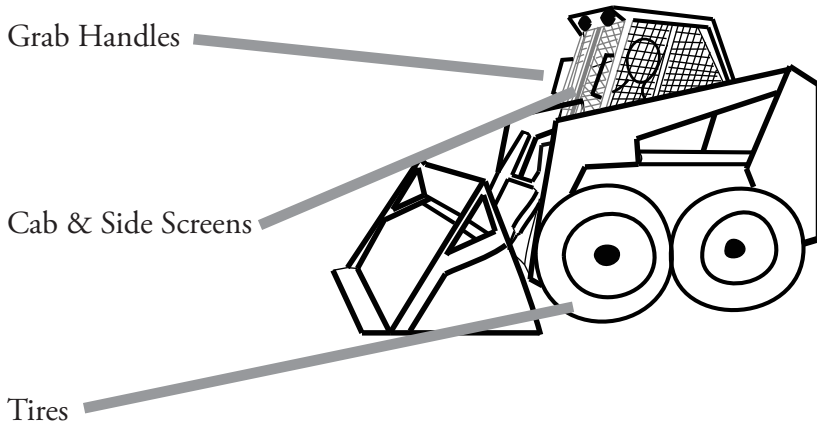

Lesson 3

1. Draw a line from the words to the areas on the loader where you or someone else could be crushed by moving parts.

Outside of the windows/
side screens

Between the lift and frame

Between lower front frame
and front tires

Step area

Under the attachment

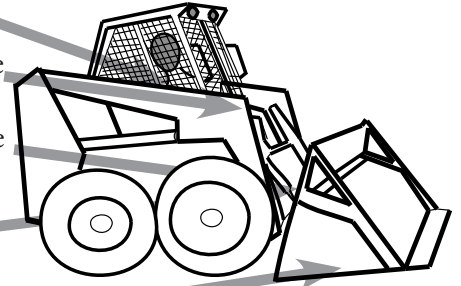

2. When the engine is running, the safest place for you is _____.

- a. Riding in the bucket
- b. Standing next to the loader
- c. Sitting in the operator's seat with the safety belt fastened and the safety bar in place

3. Circle the drawing that best shows the operator working safely in a skid steer loader with the engine running.

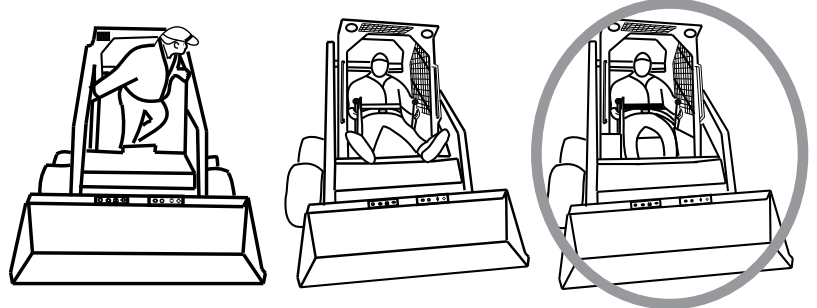

Use the list of words below to complete the sentences.

- a. Attachment
 - b. Move
 - c. Body
 - d. Engine
5. Never start the engine by shorting across starter terminals. You could be crushed if the loader starts to b .
 6. Never work or walk under a raised a .
 7. Never get in or out of the loader with the d running.
 8. Do not lean any part of your c out of the cab with the engine running.

Lesson 4

Circle the picture where the operator is working correctly.

1.



Driving down hill with the attachment up.



Driving on level ground with the attachment low.

2.

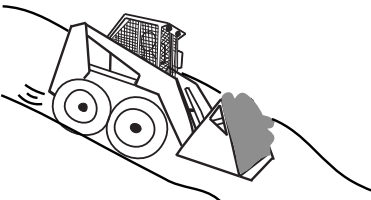

Driving down hill with a load in the bucket.

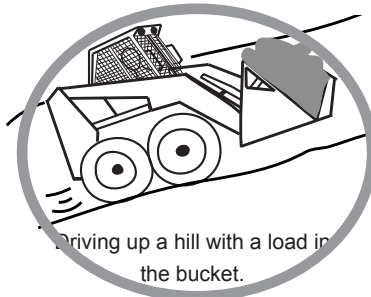

Driving up a hill with a load in the bucket.

3.

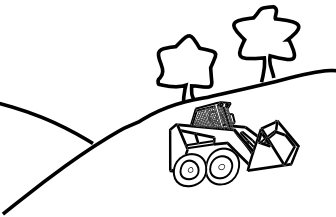

Driving across a hill with the loader empty.

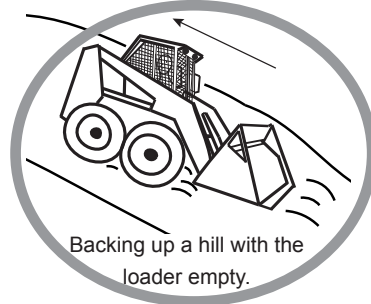

Backing up a hill with the loader empty.

4.

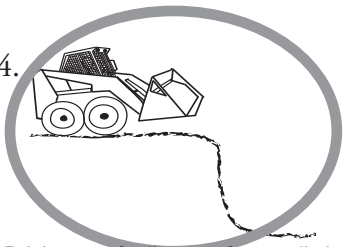

Driving a safe distance from a ditch.

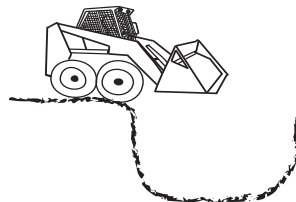

Driving to the edge of a ditch.

Use the list of words below to complete the sentences.

- a. Turns
- b. Smoothly
- c. Angle

- 5. When it is necessary to drive across railroad tracks, slow down and cross at an **c**.
- 6. Do not make sharp **a** on hills.
- 7. Operate the loader **b**.

Lesson 5

Circle the picture where the operator is working correctly.

1.



Driving onto a trailer.

2.

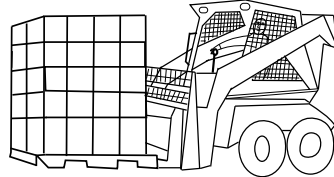

Driving with a load blocking your view.



Using a coworker to help you move a large load.

3.

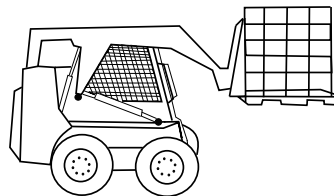

Carrying a load high off the ground.



Carrying the attachment as low to the ground as possible.

Use the list of words below to complete the sentences.

- a. Undercutting
 - b. Deadly, odorless, colorless
 - c. Leak
4. Gasoline-, diesel- and LP gas-powered skid steer loaders produce carbon monoxide (CO), a **b** gas.
5. Ask someone who is qualified to check for a hydraulic fluid **c** .
6. **a** can cause a material pile to collapse on you.

Lesson 6

Circle the correct answer.

1. Stop a cut from bleeding by applying _____.
 - a. Aloe
 - b. Ointment
 - c. Direct pressure
2. Dizziness, light headedness, headache and fatigue are all symptoms of _____.
 - a. Lightning strike
 - b. Heat exhaustion
3. It is important to take frequent, short _____ when working outside.
 - a. Strides
 - b. Phone calls
 - c. Breaks
4. To keep myself hydrated when working outside, drink _____.
 - a. Water frequently throughout the day
 - b. Only when thirsty
 - c. Soda at lunchtime
5. Lightning strikes the _____ objects.
 - a. Tallest
 - b. Widest
 - c. Shortest

Select the correct answer for the following sentences from the list below.

- a. Immediately
 - b. Stinger
 - c. Wash
 - d. Frostbitten
 - e. Lower
6. Never rub an area that has been d.
 7. The first step to treating an insect sting is to remove the b.
 8. If you contact poison ivy, oak or sumac, c the affected area as well as all clothing and tools.
 9. Hypothermia occurs when body temperature drops to 95° or e.
 10. If a person with a known allergy to insects is stung, call for help a.

Conclusion

Read the following accident report to answer the following questions. Use the list of words below to fill in the blanks.

- a. experience
- b. team
- c. cab
- d. support

Accident Report

Supervisor Crushed Between Lift Arms and Frame

Summary of NIOSH FACE Program Report Number 2000-15

An inexperienced employee was learning how to operate a skid steer loader. He began having trouble and told the production supervisor he thought there was a hydraulic problem. After the employee raised the lift arms, the production supervisor stepped under the attachment to check for a hydraulic leak. After some discussion, the production supervisor reached out and moved the lift-control lever with his hand. This caused the lift arms and attachment to come down on the supervisor, pinning him against the front chassis of the loader. The supervisor was pronounced dead at the scene.

1. The supervisor stepped under a raised attachment without an approved lift arm **d** in place.
2. The supervisor operated the controls from outside the **c**.
3. The employee did not have enough **a** to help the supervisor trouble shoot the loader with the engine running.
4. Since the engine was running, the troubleshooting should have been performed by two experienced employees working as a **b**.

You are responsible for parking the skid steer loader at the end of the workday. Use the words below to fill in the blanks in this list to tell how you should shut down safely so the loader doesn't move after it's parked.

- e. Shutdown
- f. Attachment
- g. Block

5. Lower the **f**.
6. Follow safe **e** procedures as outlined in the operator's manual.
7. **g** the wheels.

This page left blank intentionally for notes.

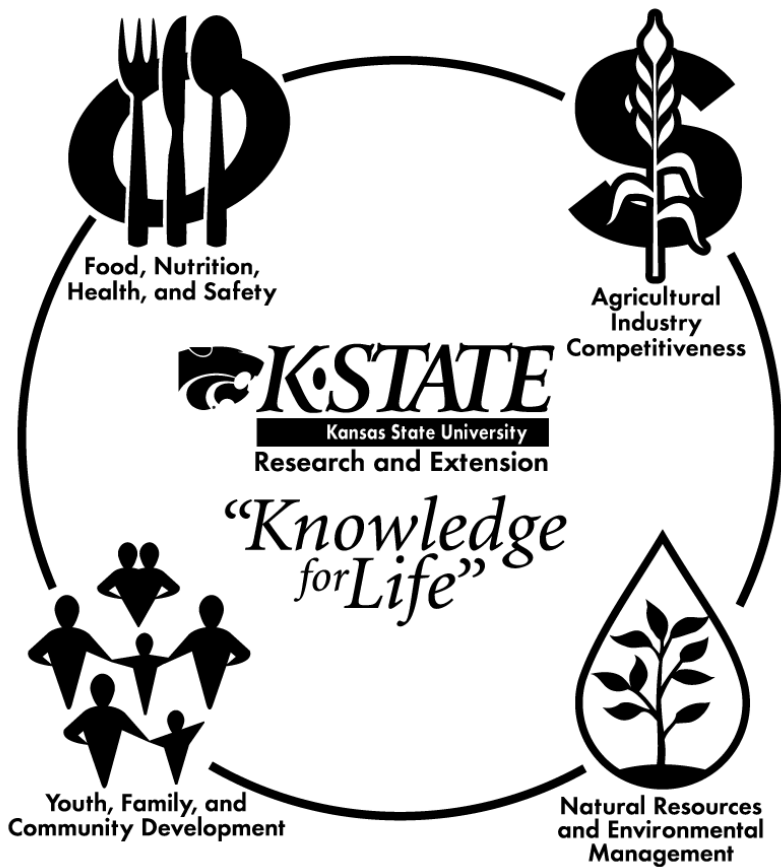

This publication is produced by K-State Research and Extension, Manhattan, Kansas, www.oznet.ksu.edu

Brand names appearing in this publication are for product identification purposes only. No endorsement is intended, nor is criticism implied of similar products not mentioned.

Kansas State University Agricultural Experiment Station and Cooperative Extension Service

MF 2711

April 2006

K-State Research and Extension is an equal opportunity provider and employer. Issued in furtherance of Cooperative Extension Work, Acts of May 8 and June 30, 1914, as amended. Kansas State University, County Extension Councils, Extension Districts, and United States Department of Agriculture Cooperating, Fred A. Cholick, Director.